

The Special Edition New England Lighthouse

Read the instructions all the way through, and test the parts for identification, to see how they fit, and to plan ahead for the finishing materials you have chosen.

Parts List:

Tower Walls:

- (3) E3924 Round Window Wall: ($\frac{3}{8}$ Milled) 28 x $6\frac{9}{16}$, Bev., Grooved
- (1) E3925 2 Window Wall: ($\frac{3}{8}$ Milled) 28 x $6\frac{9}{16}$, Bev., Grooved
- (1) E3926 Window & Door Wall: ($\frac{3}{8}$ Milled) 28 x $6\frac{9}{16}$, Bev., Grooved
- (1) E3927 Left Back Wall: ($\frac{3}{8}$ Milled) 28 x $2\frac{3}{8}$, Bev., Grooved
- (1) E3928 Right Back Wall: ($\frac{3}{8}$ Milled) 28 x $2\frac{3}{8}$, Bev., Grooved

Floors:

- (1) E3929 Gallery Deck: ($\frac{3}{8}$ MDF) $15\frac{5}{16}$ x $15\frac{5}{16}$, Ladder hole
- (1) E3930 Base Floor: ($\frac{3}{8}$ MDF) $15\frac{5}{16}$ x $15\frac{5}{16}$
- (1) E3931 Middle Floor: ($\frac{3}{8}$ MDF) $13\frac{13}{16}$ x $13\frac{13}{16}$, Stair hole
- (1) E3932 Upper Floor: ($\frac{3}{8}$ MDF) $12\frac{11}{32}$ x $12\frac{11}{32}$, Stair hole

Foundation:

- (7) E3933 Foundation: ($\frac{3}{4}$ MDF) $6\frac{3}{4}$ x $1\frac{3}{4}$, Bev.
- (2) E3934 Foundation: ($\frac{3}{4}$ MDF) $\frac{5}{8}$ x $1\frac{3}{4}$, Bev.
- (2) E3935 Foundation: ($\frac{5}{8}$ MDF) 6 x $1\frac{3}{4}$
- (1) E3936 Foundation: ($\frac{5}{8}$ MDF) $4\frac{1}{4}$ x $1\frac{3}{4}$
- (1) E3937 Step: ($\frac{5}{8}$ MDF) $4\frac{1}{4}$ x $\frac{3}{4}$

Entryway:

- (1) E3938 Entry Front: ($\frac{3}{8}$ Milled) $11\frac{7}{8}$ x $4\frac{1}{4}$, Door Cutout
- (1) E3939 Entry Left Side: ($\frac{3}{8}$ Milled) 8 x $5\frac{21}{32}$, Bev.
- (1) E3940 Entry Right Side: ($\frac{3}{8}$ Milled) 8 x $5\frac{21}{32}$, Bev.
- (1) E3941 Entry Floor: ($\frac{3}{8}$ MDF) $4\frac{1}{4}$ x $4\frac{3}{4}$
- (1) E3942 Entry Left Roof: ($\frac{1}{4}$ MDF) $6\frac{11}{32}$ x $4\frac{1}{4}$
- (1) E3943 Entry Right Roof: ($\frac{1}{4}$ MDF) $6\frac{11}{32}$ x 4

Beacon Housing:

- (8) E3944 Lower Wall: ($\frac{1}{8}$ Milled) $3\frac{3}{8}$ x 3
- (8) E3945 Upper Wall: ($\frac{1}{8}$ Milled) 1 x 3
- (8) E3946 Connectors ($\frac{1}{2}$ MDF) $9\frac{1}{2}$, Grooves
- (16) E3947 Sill ($\frac{3}{8}$ MDF) $\frac{1}{2}$ x $2\frac{7}{8}$, Grooves
- (8) E3948 Window Pane: (Plexi) $4\frac{3}{4}$ x 3
- (8) E3949 Roof: ($\frac{1}{4}$ MDF) $4\frac{15}{16}$ x $3\frac{7}{8}$ Base, Bev.
- (1) E3950 Finial
- (PR) E3969 Hook & Loop Material (2")

Light Stand:

- (3) E3951 Stand Upright: ($\frac{3}{8}$ MDF) $2\frac{3}{4}$ x $2\frac{3}{4}$
- (4) E3952 Lens Keeper ($\frac{1}{4}$ MDF) $\frac{7}{8}$ x $1\frac{1}{2}$, bev.
- (1) E3953 Lamp Deck ($\frac{1}{8}$ MDF) 5 x 5, 1" hole

Ladder:

- (1) E3970-1 Assembled Ladder

Rails:

- (8) E3957-9 Assembled Rails: $5\frac{3}{4}$

Details:

- (8) E3958 Post: ($\frac{3}{8}$ Pine) $2\frac{3}{4}$, Bev.
- (8) E3960 Bead: ($\frac{3}{8}$ Bead)

Trim:

- (4) E3966 Stripwood: ($\frac{1}{2}$ pine) $\frac{3}{32}$ x over $23\frac{1}{2}$
- (3) E3967 Stripwood: ($\frac{1}{4}$ pine) $\frac{1}{8}$ x over $23\frac{1}{2}$
- (1) E3968 Stripwood: ($\frac{3}{8}$ pine) $\frac{3}{8}$ x over $23\frac{1}{2}$
- (2) E3963 Wire Cap - Corner: 28
- (1) E3964 Wire Cap - Channel: 8
- (2) E3965 Rail J: over $23\frac{1}{2}$

Paint the exposed surfaces of the Rails, Stripwood, Door, and Window parts before assembly; but you must not sand or paint the gluing surfaces. Planning makes the project easier!

Electrical:

- (1) E3917 Lens
- (1) E3916 Cord w/ Switch & Plug: 8'
- (1) E3919 Flashing Bulb (This an ordinary flashing Christmas tree bulb. Replacements are available at your local hardware store)
- (1) E3918 Night Light Bulb (This an ordinary night light bulb. Replacements are available at your local hardware store)

Stairs:

- (2) E3954 Landing: ($\frac{1}{4}$ MDF) $2\frac{1}{4}$, Bevels
- (4) E3955 Stair Block (Molding) $2\frac{1}{4}$
- (2) E3956 Groove-Fill: ($\frac{3}{8}$ MDF) $\frac{1}{8}$ x $3\frac{3}{4}$

Windows:

- (12) T1020 Vertical Frame: $5\frac{5}{16}$, Mitered
- (12) T1021 Horizontal Frame: $2\frac{13}{16}$, Mitered
- (3) T1022 Standard Printed Pane: $2\frac{1}{2}$ x 5
- (6) T1024 Round Window Frame
- (3) T1025 Round Printed Pane

Door:

- (1) #6041 Assembled Door
GW1008 Knob



LH-100 and JM122
Each Sold Separately

Congratulations on your purchase of a *Real Good Toys* product. Your kit has been precision made with meticulous care by craftpeople using only the finest quality materials.

This lighthouse will last for years, even generations, if proper care and attention is given during assembly. Take your time during assembly and be sure to read the instructions completely before you proceed.

Check all parts and packs against the parts list before beginning construction to identify the parts and to make sure you have everything. If you need replacement parts be sure to include the exact name and measurements taken directly from the parts list.

Assembly Notes:

A large, clutter-free, well lighted work area is most helpful during assembly, and a flat work surface is essential.

Supplies:

White glue	Fine Tooth Saw
Masking tape	Sandpaper
Elastic bands	Pencil
Utility knife	Ruler

Don't be stingy with glue or tape. Use generous amounts of glue. Always wipe off excess glue immediately.

Read the instructions carefully, look at each of the illustrations. With the parts in your hands, think the assembly through before you proceed.

Always test fit (no glue) parts before final assembly. Sand any rough edges or splinters before gluing.

Check all the joints to be sure everything is tight or straight. If more tape or a helper is needed, it's good to know that before the parts have glue on them.

Make sure everything is straight and flat as the glue dries... That's the shape that will be permanent.

Make all joints flush. Keep surfaces and edges square.

Painting: Paint the clapboard walls prior to assembly. Use high quality semi-gloss latex enamel, sanding between coats with 320 grit silicone carbide sandpaper. Avoid old gloppy paint and poor quality paint brushes. Do not paint surfaces to be glued.

After assembly but before any outside details are attached, repair any defects, sand carefully with 320 grit silicone carbide sandpaper one clapboard course at a time, then re-paint. Sometimes a 3rd coat is necessary.

Options:

A wide variety of materials and accessories are available to help you achieve your dream house.

The following is a partial list of accessories available through your dealer from *Real Good Toys*.

#T10	Turntable
#EL66	All-purpose MDF punch set (Handy for pre-punching and a variety of electrification operations)

This lighthouse may be built to attach to a light keepers house. If you intend to attach the lighthouse to another dollhouse, delay the entryway assembly.

When we attach this lighthouse to the Real Good Toys' Keeper's House (Model #J-M122) dollhouse, we omit the entryway front, we raise the entryway floor to match up with the house floor, and we cut the entryway roofs to fit. Then the entryway becomes a passage to the house.

Note:

Real Good Toys, Inc. does not guarantee the operation or safety of the wiring supplied with the lighthouse. This electrical equipment is responsibly manufactured, U.L. Listed, and packaged with care. The assembler must feel comfortable that these parts are safe to use.

Never use electrical equipment that is worn or broken. Never run electrical wires under furniture or rugs. Do not use bulbs hotter than 15 watts.

This lighthouse is very attractive as a soft light lamp with an ordinary night light bulb, or even no light at all.

Windows:

The parts used in this section should be painted ahead of time. The windows are shown first so that they can be worked on one step at a time, and will be done when they are needed

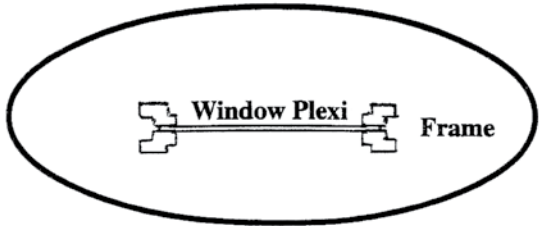

The hands are pressing the Window parts down, not Squeezing them together



Top Frame

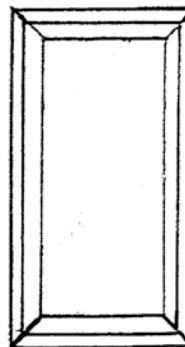

Side Frame

Bottom Frame

- 1. Test assemble (**no glue**) a window set
Practice holding the frame pieces face-down on the work surface and putting on the rubber band. When you can do it every time without pieces flying, then you are ready for glue.

Note: a snip of tape in the corners will help keep pieces from flying

- 2. Glue and rubber band together all (6) window frames. Make sure each assembly is square as the glue dries.

- 3. Touch-up the sanding and paint.

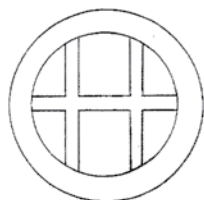
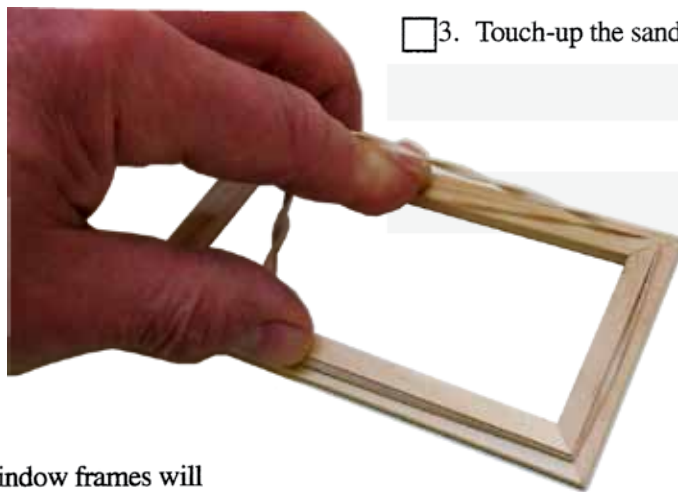

- 4. Round Window: Two round window frames will be used for each unit. The printed plexi sets between the interior and exterior frames.

- 5. Check the fit of the windows in the openings. Make sure the windows can sit level with the Lighthouse. Trim the corners of the openings square if necessary for a good fit.

Glue the windows in place only after the Lighthouse body is fully assembled and painted. The printed plexi sets between the frames just like the round windows.

Pre-Assembled Door

This Special Edition kit includes an assembled door. Pull out the pins to disassemble the door for painting. Tape the pins to the bottom of the door so they don't get lost!

- Touch-up the sanding and paint. Check the fit of the door in the opening. Make sure the door can sit level with the house. Trim the corners of the opening square if necessary for a good fit. Glue the door in place only after the entryway is assembled and painted,, and other interior finishing is done.

Special Addition: the Rails are Pre-Assembled

Rails

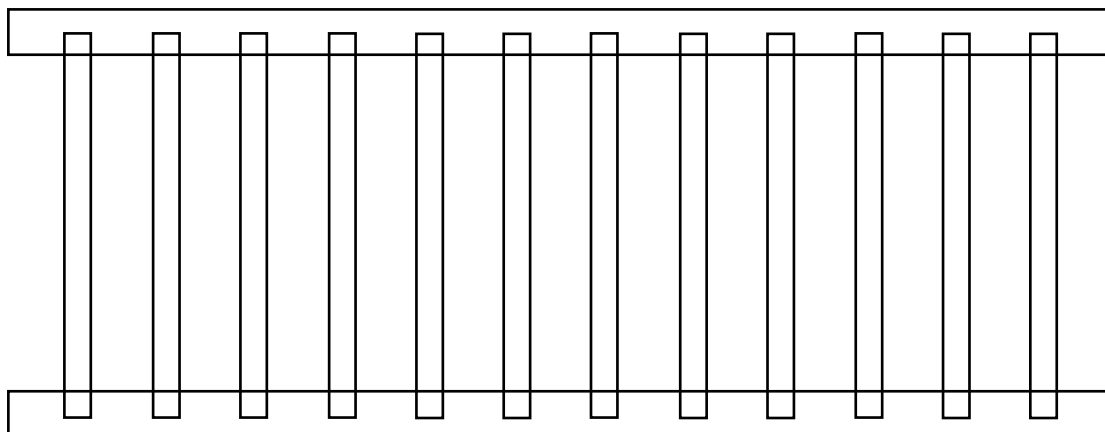

Assemble the Rails

1. Paint (the first coat) and sand the Rails before assembly. Wipe any paint out of the grooves, and do not paint the Rail ends at all.

Paint and sand the Dowels:

a. Dab paint onto a small-celled sponge, less paint is better (a small-celled sponge looks like sponge rubber. Our local dollar store sells small-celled sponges with a scrubby back - cut in half, they are just right).

Put several Dowels on the sponge; rub a second sponge across the top, rolling the Dowels across the paint-sponge.

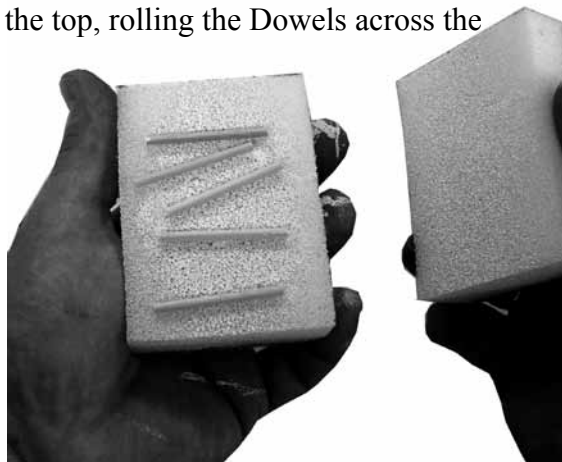

b. Spread the painted Dowels on waxed paper. Move them around every few minutes as the paint dries

c. Paint all of the Dowels; let the paint dry

d. Lightly rub the dowels around with sandpaper (a small handful at a time) to sand off the raised grain.



Second-coat the paint after the Railings are assembled

2. Assemble the Railings:

a. Match Rails into pairs.

b. Set the first Rail of each pair on the drawing, lined up on each end. Put a dab of glue and a Dowel in the Rail's groove for each Dowel in the drawing. Adjust the Dowels to match the drawing; be sure all the Dowels are even, straight, and square. Let the glue dry for a few minutes.

c. Lift the Dowels with a piece of stripwood; dab a little glue onto each Dowel's end. Hold the second Rail of the pair over the Dowel's ends at an angle. Push down and scoop the Dowels' ends into the groove.

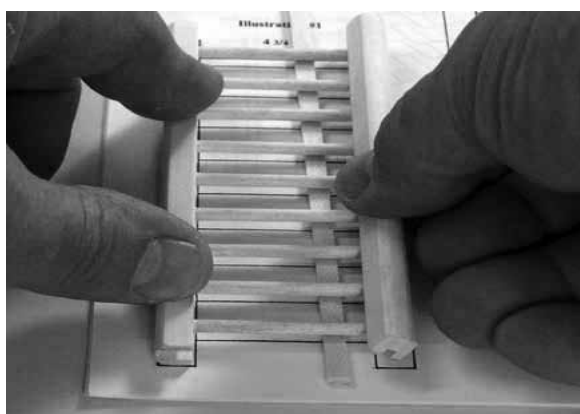

Squeeze the Rails together so the Dowels are fully in the grooves. Hold the Railing set on the drawing; make the Rail ends exactly line up. Final adjust the Dowels - - straight and square. Tape together square Foundation parts to form a square inside corner, and lay the Railings in the corner as the glue dries to hold them square

d. Repeat for the other Railings

3. Paint (second-coat) the Railings

Tower Walls:

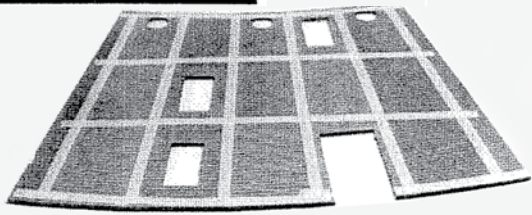

1. Lay out the pre-painted Walls with the clapboard up. Tape the wall set together, carefully lined up at the bottom edge.

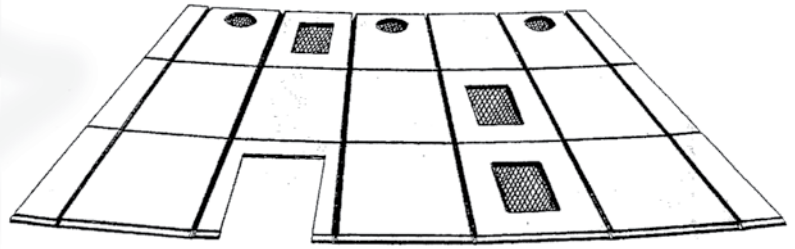

2. Turn the wall set over (two people are much better at evenly supporting all the parts so the tape stays stuck). Spread glue in all the grooves.

Careful!

See how the stair hole aims.

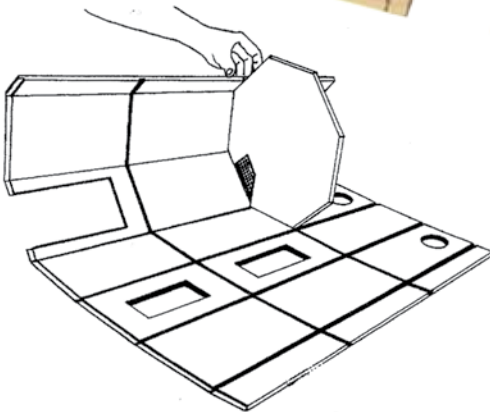

3. Set the 3rd Floor in the 3rd floor groove of the entryway panel. **Note the position and orientation of the stair hole.** Begin to wrap the walls around the floor.

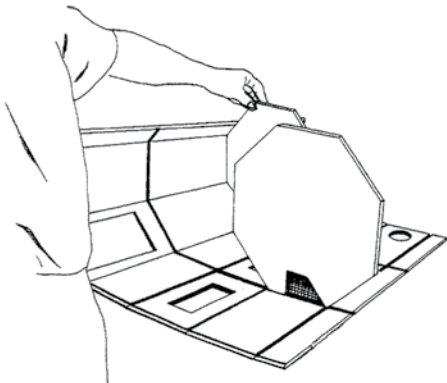

4. Set the 2nd Floor in the 2nd floor's groove. **Note the position and orientation of the stair hole.**

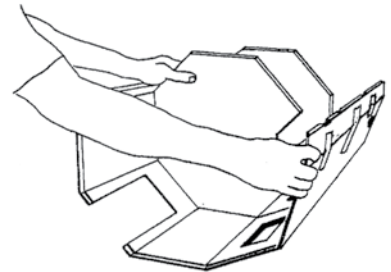

5. Finish wrapping the walls around the floors. Tape the walls to the floors and all the way across the back to hold them tight.

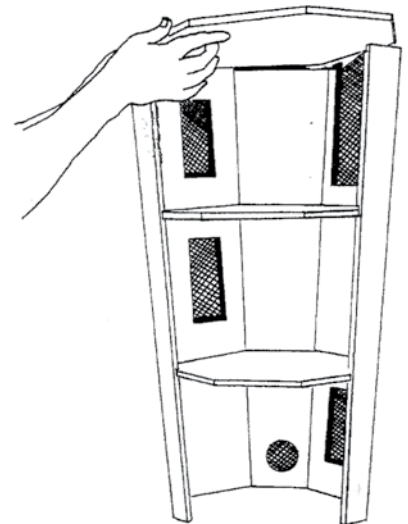

6. Set the Base Floor in place. Tape the walls firmly to the Base Floor.

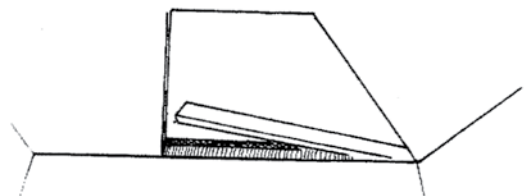

7. Glue the Groove-Fills into the grooves left exposed in the stair holes to leave a smooth interior wall.

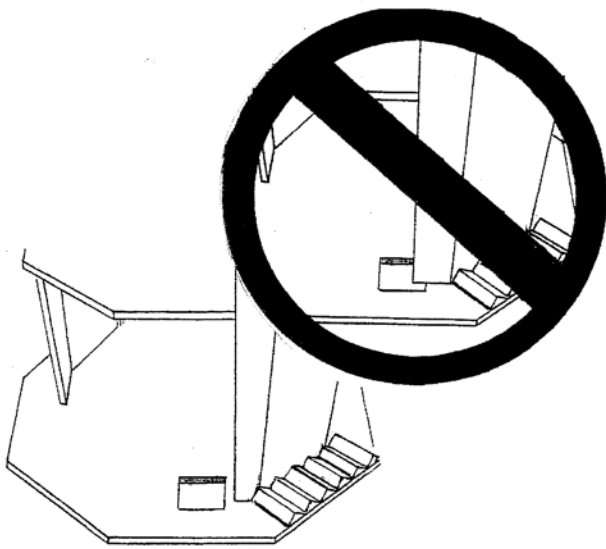

When the stair-blocks overhang evenly all the way around the Gallery Deck, the walls are centered.

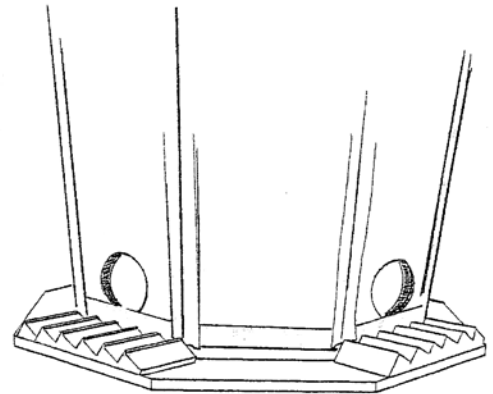

8. Test the wall set up-side-down on the Gallery Deck. If the wall set hangs over the ladder hole, turn the Gallery Deck over.

9. Glue the walls to the Gallery Deck using the Stair Blocks to help find the center.

Foundation:

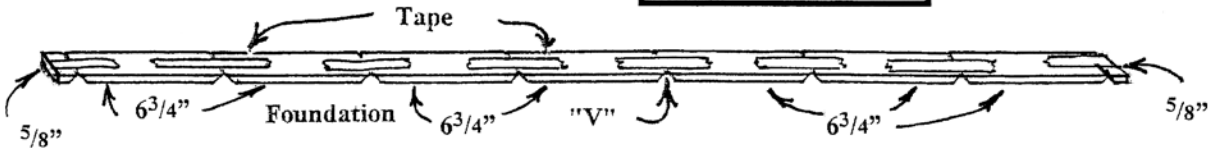

2. Tape the foundation into an octagon with the un-glued parts for the entryway foundation as a spacer.

1. Tape the foundation together: (7) beveled pieces $6\frac{3}{4}$ " and (2) beveled pieces $\frac{5}{8}$ ". Turn the foundation over and put glue in all the "V" grooves. Do not put glue on the square ends of the $\frac{5}{8}$ " foundations.

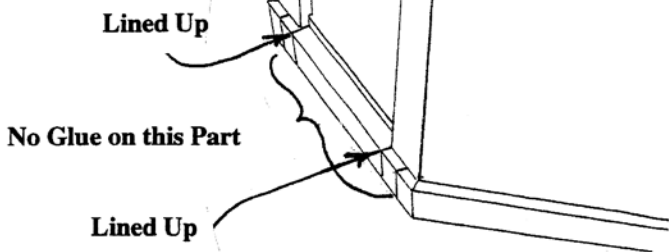
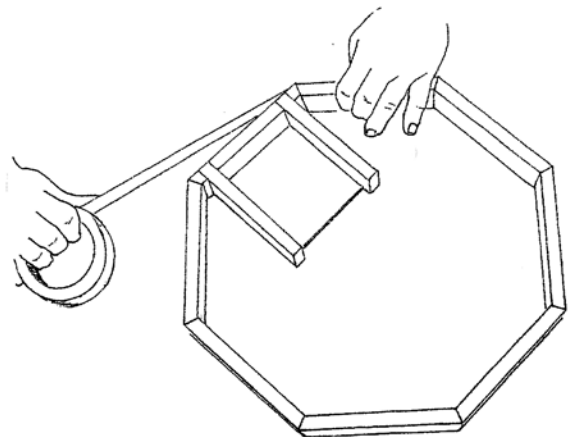

3. Do not get any glue on the entryway foundation parts. Glue the wall set to the foundation spaced evenly ($\frac{1}{4}$ " at the walls and $\frac{1}{2}$ " at the floor edges).

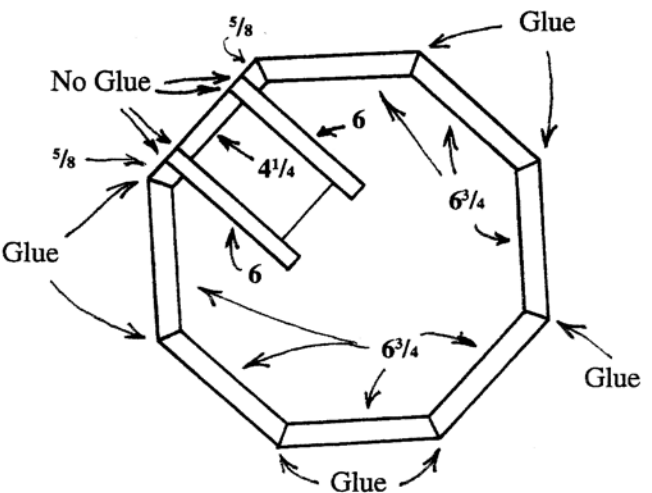

Carefully line up the un-glued entryway foundation parts with the entryway cutout.

Stairs:

Install the stairs after other interior finishing is done

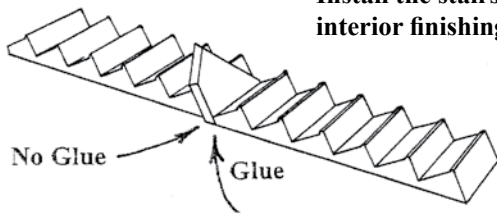

1. Glue the Stair Landing to the bottom edge of a Stair Block. Use another Stair Block to hold the Landing tight and lined up on the wall edge (closer to you in this picture)

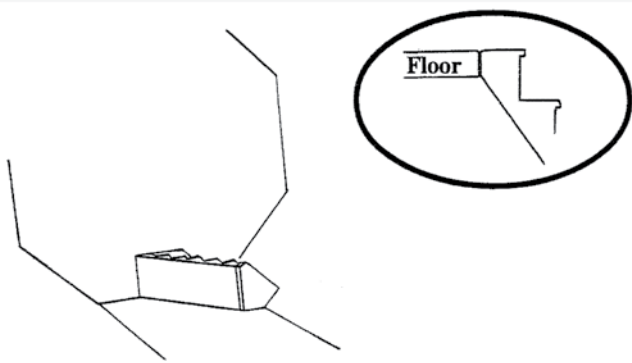
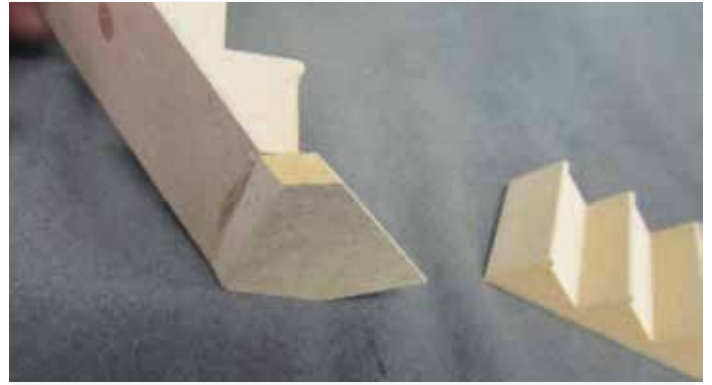

Note: The base assembly has been removed for illustration purposes only.

2. Glue the upper Stair Block and Landing to the wall and floor, flush to the top of the next higher floor and lined up in the corner.

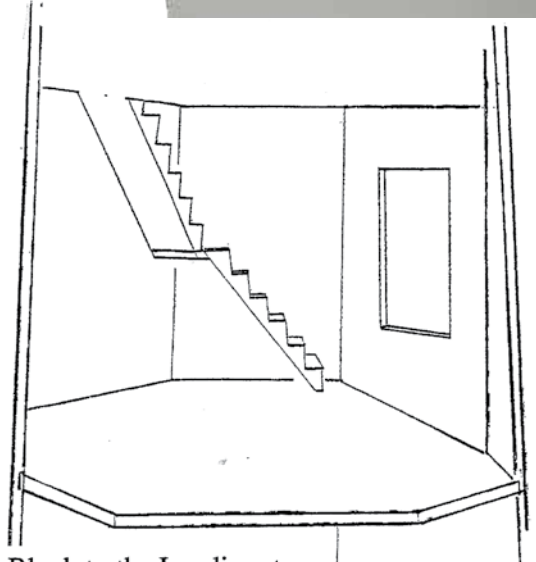
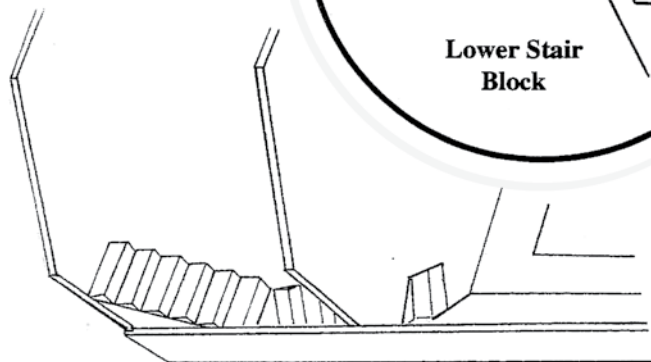
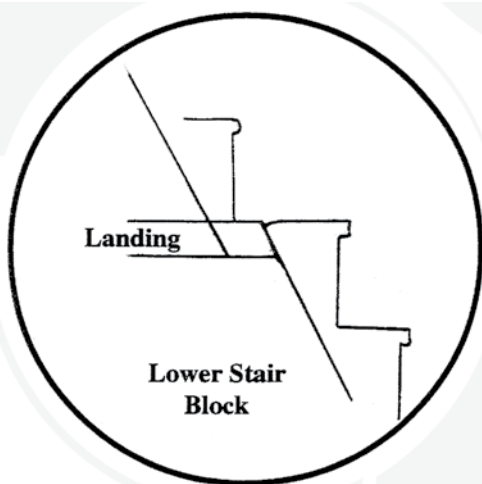

3. Glue the lower Stair Block to the Landing, to the wall, and to the next floor down.

Entryway:

See: www.realgoodtoys.help for lighthouse assembly photo galleries

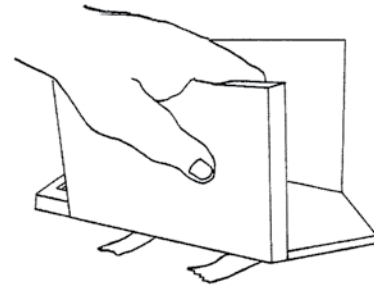
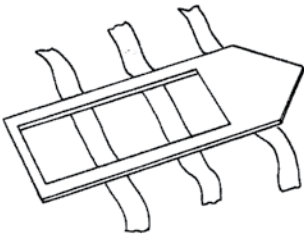

1. Glue and tape the Entryway Sides to the edges of the Entryway Front; the Sides overlap the Front. Note: The Entryway Sides have a slight angle at the back edge, making the Side wider at the top then the bottom. Make sure you are gluing the **front** edge to the Entryway Front.

2. Carefully line up the roof edge of the Entryway Front to make a straight line with the top edge of the Entryway Side

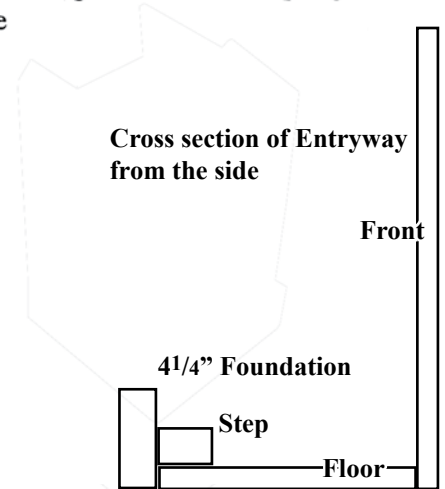
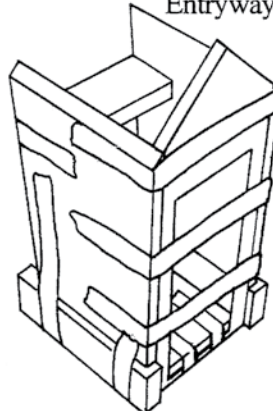
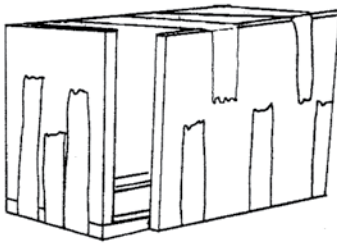

3. Glue the Entryway Floor to the Entryway Front; the Front overlaps the Floor.

4. Glue the $\frac{5}{8}$ " x $1\frac{3}{4}$ " x 6" square ended Foundations to the Entryway walls, flush on the inside, and sticking out $\frac{1}{4}$ " on the front (the same as at the sides). Glue the $4\frac{1}{4}$ " foundation and the Step to the back of the floor between the 6" foundations.

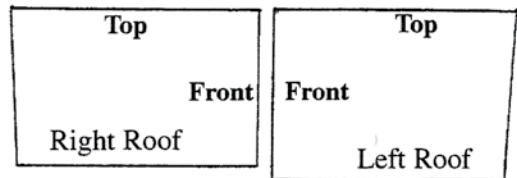
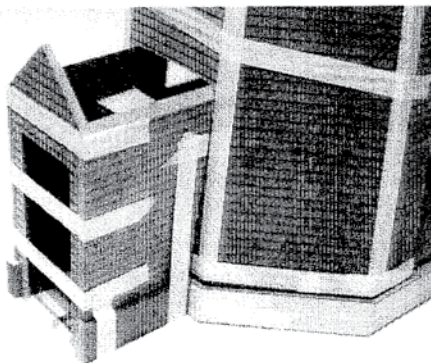

5. Glue and tape the entryway to the tower, lined up on the inside with the cutout.

6. Identify the top (longer) and front (square) edges of the Entryway Roofs. The back edges are angled slightly, so look carefully!

www.dhbuilder.com has lighthouse assembly photo galleries

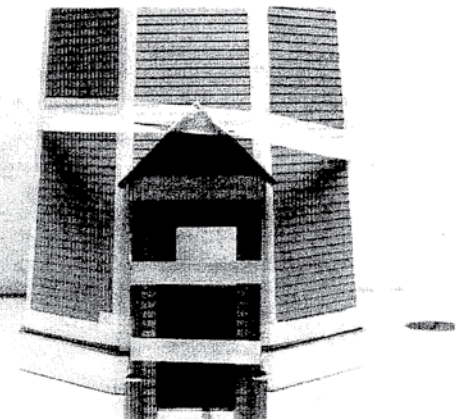
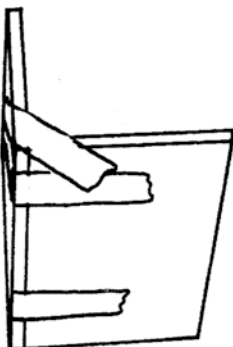

7. Glue and tape together the Entryway Roofs; the Left Roof overlaps the Right Roof.

8. Glue and tape the Entryway Roofs to the Entryway and tower. Use lots of tape for a good fit.

Trim:

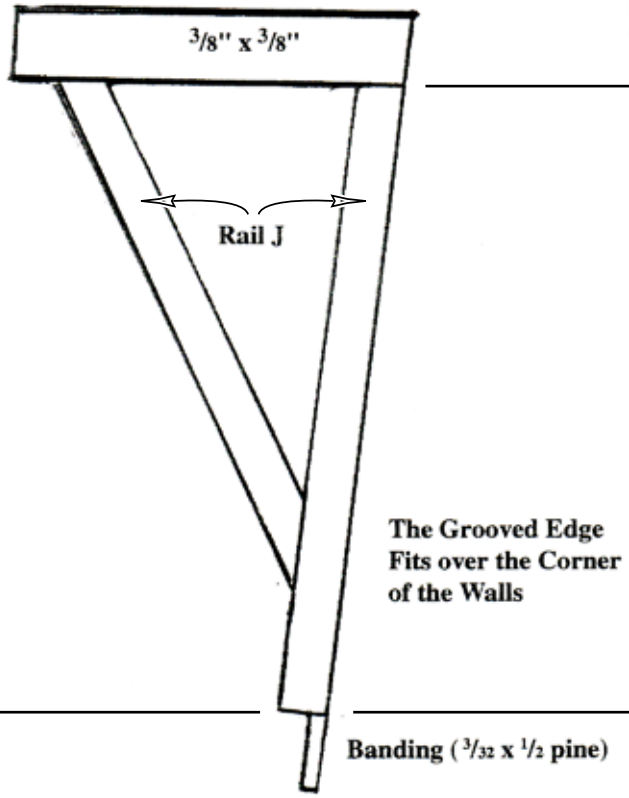

Cut trim stock to fit, using a fine toothed saw, a sharp utility knife, or scissors. Plan ahead to cut the longest pieces first. Paint then glue and tape the Trim in place.

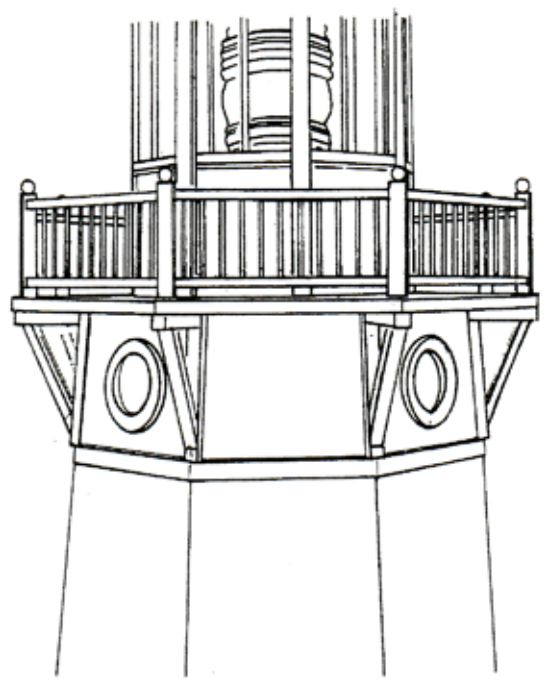

- 1. Gallery Supports:
 - A. Cut Rail J and $3/8" \times 3/8"$ Trim following the illustration.
 - B. Paint then glue the trim and Rail J together with the tower up-side-down.

C. Cut and glue the banding to the tower touching the Brackets

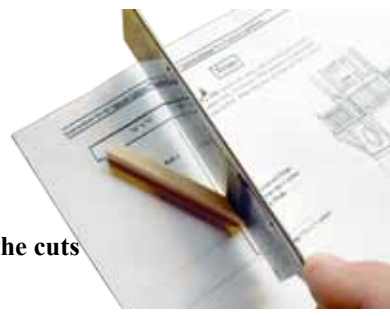

The Diagram guides the cuts

Assemble in place with the Tower up-side-down



Cut Banding: Follow the seem to get the perfect angle

Beacon Housing:

Paint the Beacon Housing Walls, Sills, and Connectors before assembly; do not paint the ends of the Sills or Walls, or paint in the grooves.

see www.realgoodtoys.help

Pre-assembly of 4 wall sections makes control of all the parts easier

- 1. Set up the beacon housing once without glue to see how everything fits and to see where glue is to be used (do not glue the Plexiglass in place ... it will change size with changes in temperature and must be allowed to "float" in the grooves).

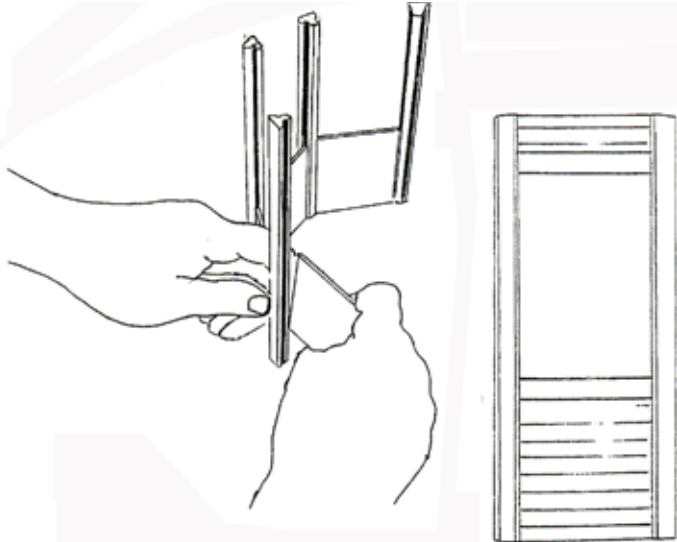

- 2. Slide the Lower Walls into the Connector slots. Make sure the Clapboard Profile is down.

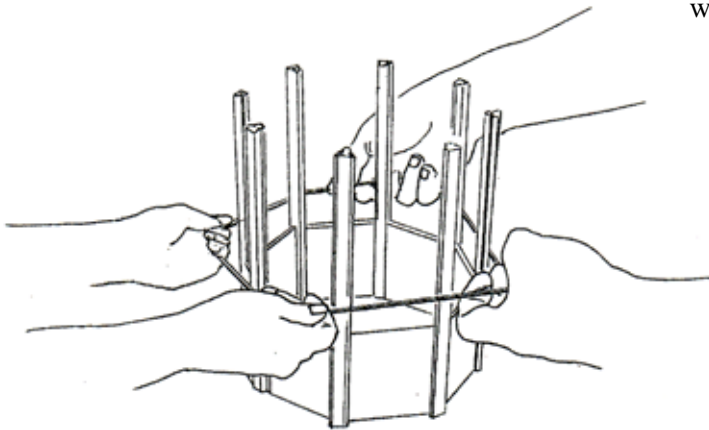

- 3. With a helper, stretch a rubber band around the Beacon Housing in the middle of the Lower Walls.

Press the Sills onto the Lower Walls from the top. Push the Lower Walls all the way down to the work surface. The Sills will make the Lower Walls loose in the Connector's grooves.

Continue without stopping.

- 4. Set the Plexi in place (do not glue).
- 5. Set a sill in place over the Plexi.
- 6. Set an Upper Wall into the slot of the Sill.
- 7. With a helper, stretch a Rubber Band around the Beacon Housing near the top.



Wall 1" x 3"



Alternate technique: build around 7" bowl and tighten with 3 wraps of string pulled thru a loop in the end



Sill

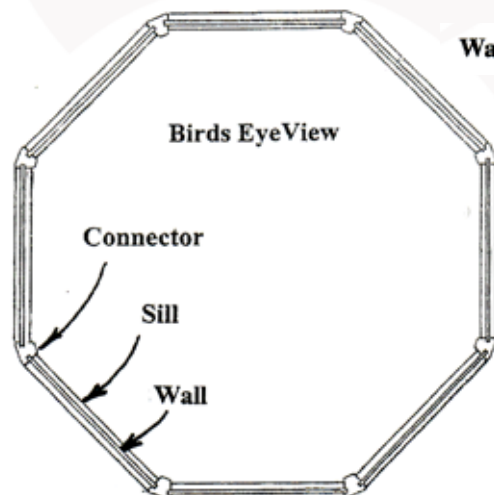

Wall 1" x 3³/₈"



8. Turn the beacon housing over and press the upper Sill and Wall to the ends of the Connectors.

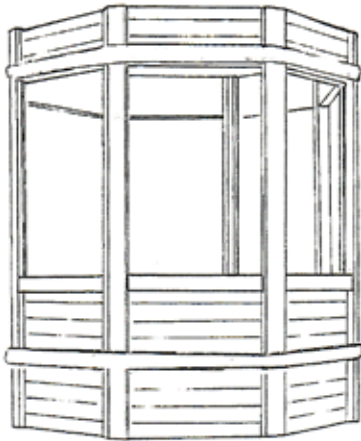

3 rounds of string pulled thru a loop is easier to control than rubber bands

Let the glue dry.

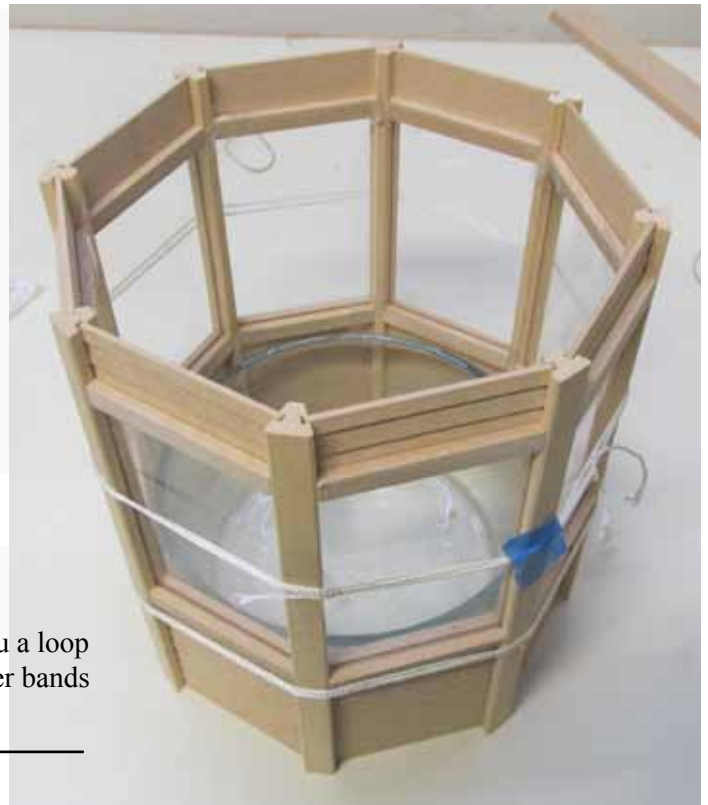

Beacon Stand:

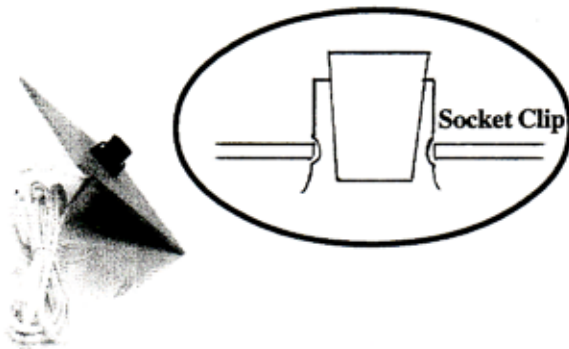

1. The Light Socket has springy clips with slots that grab the Lamp Deck.

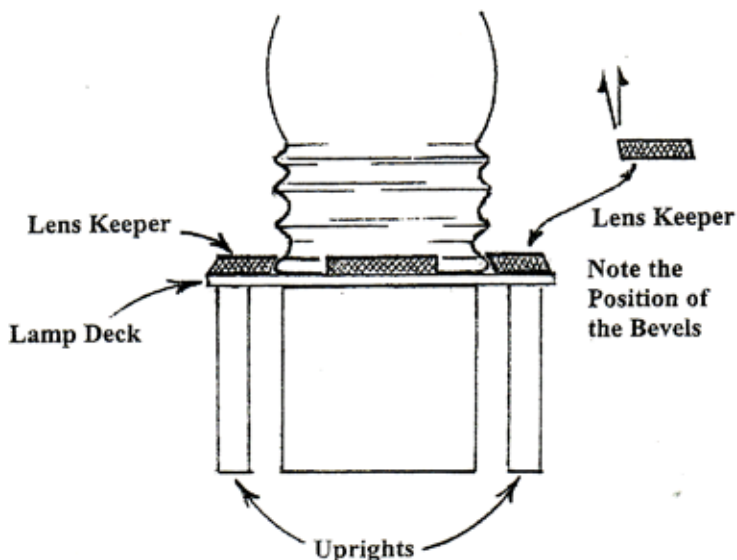
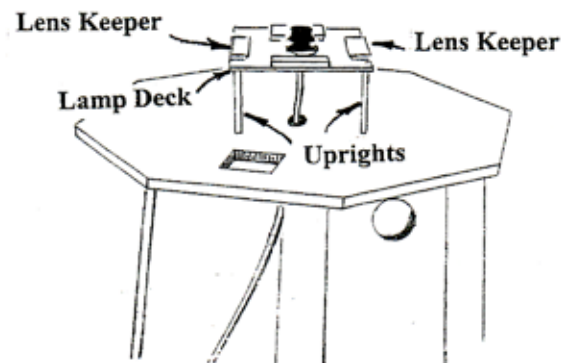

2. Glue together the Lamp Deck and the Uprights. Set the Lens on the Beacon Stand. Glue the Lens Keepers to the Lamp Deck with the bevels angled to the inside to catch the rim of the lens. Glue the Beacon Stand to the Gallery Deck, with the Lamp Deck hole directly above the wiring hole in the Gallery Deck.

3. Tape the Wire to the tower wall edge. Make sure the Wire is lined up with the outside edge of the walls, un-twisted, and has a sharp bend where it goes from the wall to the ceiling. Bend the Wire right over and pinch in tight to start the bend so it will fit inside the Wire Cap (see section #4 on page 13).

Railing/Posts :

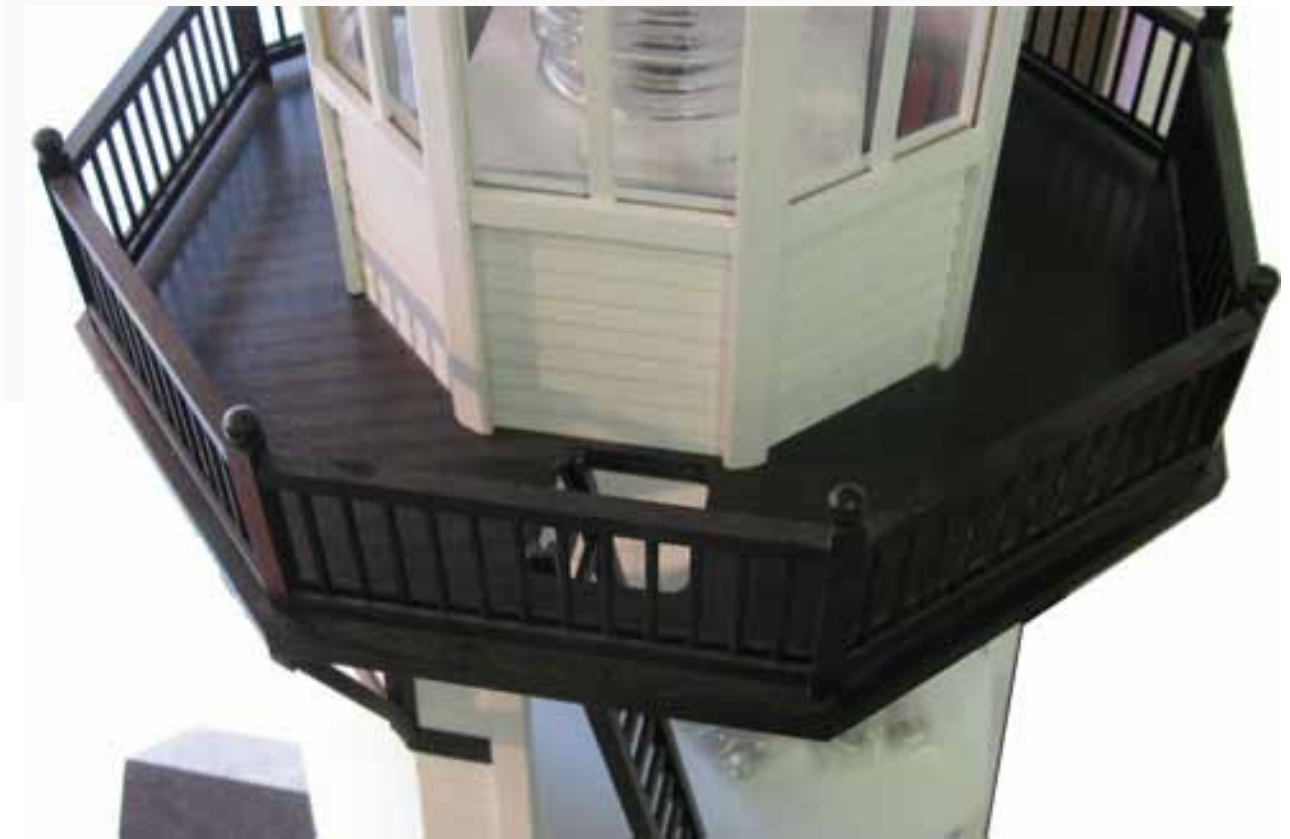

1. Rails: *If the rails have not been painted yet, do so now.*

2. Assemble the Post/Bead sets.

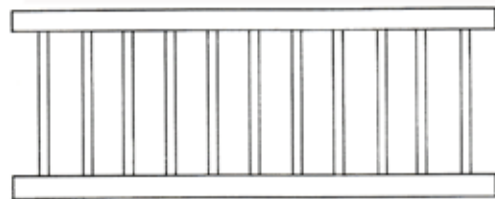
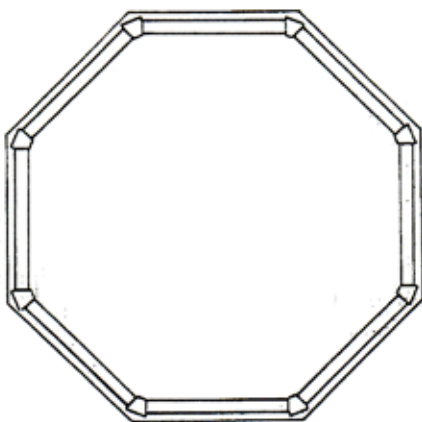

3. Without glue set up the rails and posts as shown. Use $\frac{1}{4}$ " thick scraps to elevate the Railing sets above the Deck. Remove the Rails and Posts one section at a time then glue back in place. Keep the Rails and Posts straight and positioned as the glue dries.

Special Addition: the Ladder is Pre-Assembled

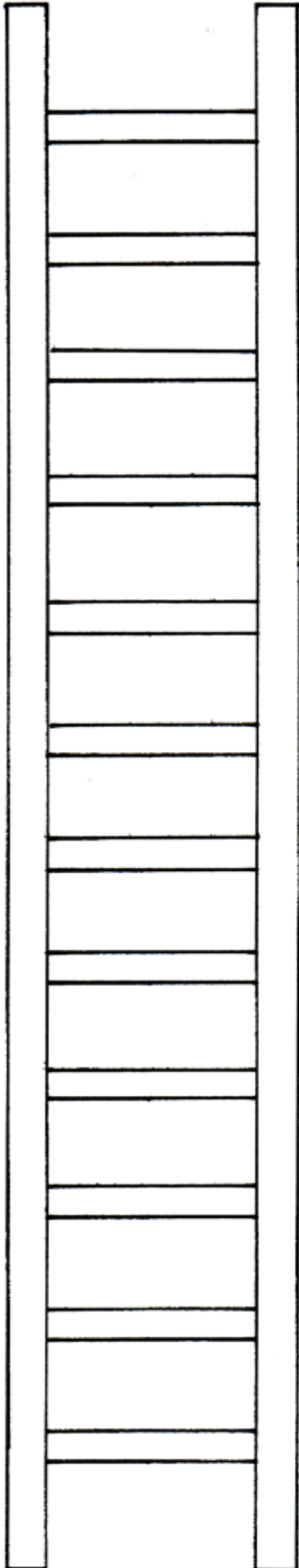

2. **Ladder:** Cut from Rail material and 1/4" Stripwood
Cut and paint rungs for the Ladder from 1/4" Stripwood.
Assemble the Ladder following the diagram



3. Cut, paint and glue the
Entryway trim in place .

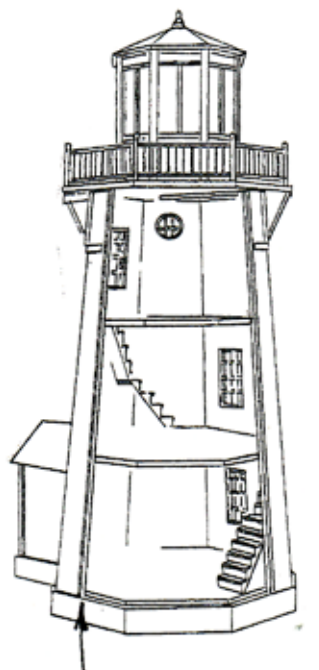
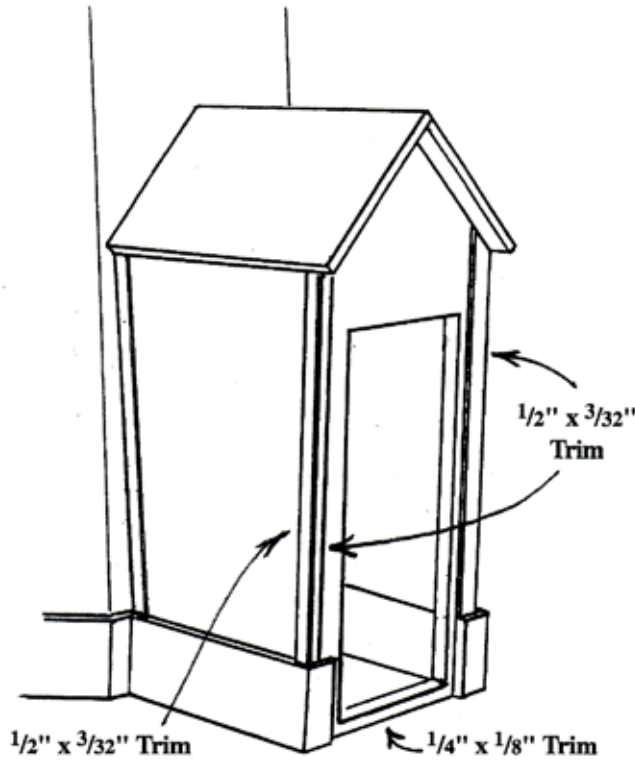

**Wire Cap Corner Only
Dresses this Edge**

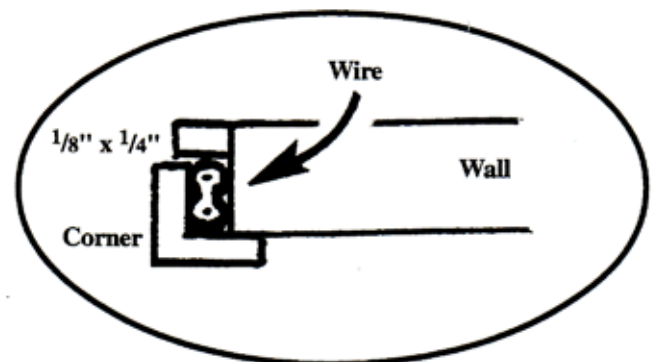

4. Cut and glue the Wire Cap over the Wire, with the corner trim on the outside, and with the 1/8" x 1/4" cut-to-fit between the floors.

Our assembly pro likes silicone glue, using enough to glue the whole wire in place along with the corner, but white glue and tape does the trick too. Just be sure the Wire Cap is taped tight to the Wire all the way.

5. Cut 8 pieces of 1/8" x 1/4" stripwood for mullions (see page 14). Cut each mullion individually for a perfect fit.

5. Glue the Channel Wire Cap over the ceiling section of wire. You may notch the right end to complete the corner with a tidy fit. The wiring access hole in the Gallery Deck may be left slightly exposed behind the Channel without it being visible.

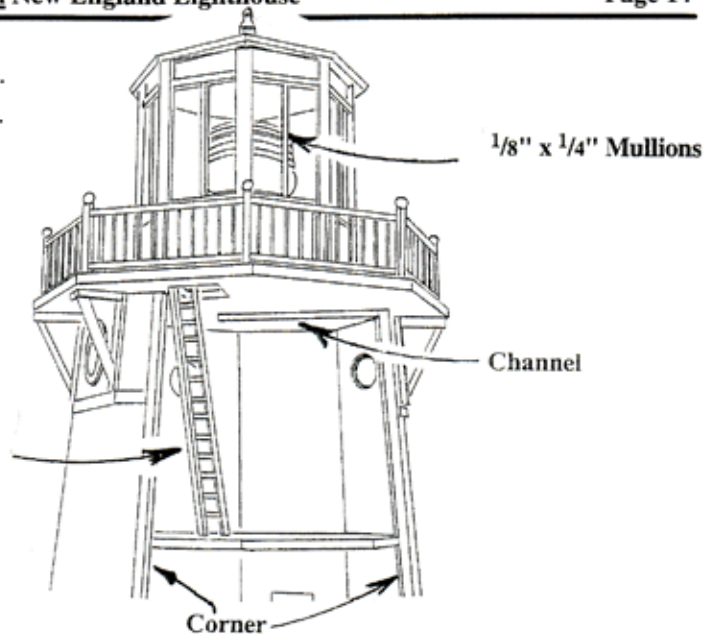

Roof:

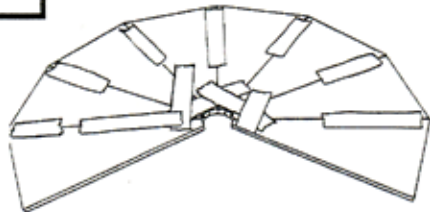

1. Lay out the Roof panels, with the V-groove (formed by the bevels) on the bottom. Tape the panels together. Turn the panels over and spread glue in the V-Grooves.

2. Fold the Roof into a cone shape and tape together.

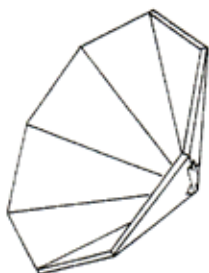

3. (Two Options) Glue the roof to the beacon housing with dabs of silicon glue at the corners, and leave the beacon housing separate from the Gallery Deck.

OR: Glue the beacon housing to the Gallery Deck. Cut 1/2" pairs of the hook and loop material. Glue them to the top of four beacon housing connectors. With a plump dab of silicon glue, glue the other end to the roof set. Adjust the roof and let the glue dry over-night.

4. Glue the Finial into the hole formed at the peak of the roof.

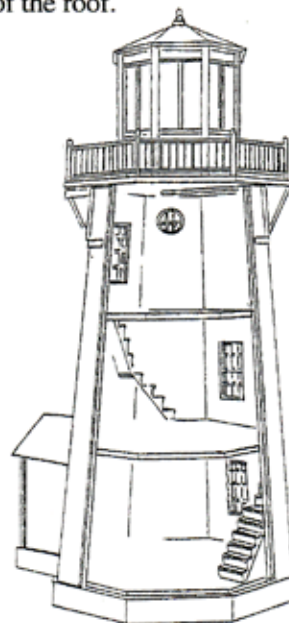

#LH-100 Interior View

**You have finished the Lighthouse part of your project ...
ENJOY THE REST!**

Detail photos of an LH100 with optional shingles





This LH100 has optional Shingles and Door Knob

