

Congratulations on your choice of a Real Good Toys product. Your kit has been precision made with meticulous care by our craftspeople using carefully selected materials. This Dollhouse will last for years, even generations, if heirloom care and attention is given during assembly. Take your time and read the instructions completely. If you have questions, ask the experts at your local Dollhouse store or at info@realgoodtoys.com

Before you begin - You have already opened the box and see all the parts organized in boxes and bundles. For the moment, keep them that way. There are important things to do before you open your glue bottle.

Prepare your space: This dollhouse will spread out over a large area while it is being built. You will need a large flat tabletop for the house, several boxes to keep parts organized until they are needed, and several trays lined with waxed paper for holding small parts like windows and railings. A snap-lid box will keep your tools and supplies handy between building sessions.

Preview the Overview (page 3) to plan and organize your build; this helps make it fun and fulfilling.

Measure and identify the parts: The kit is packed in groupings that protect the parts, and that is how the Parts List is organized. As you measure and identify the parts, label them with sticky notes using the names from the parts list, and check them off the parts list so you know you have everything. *Taking the time now to identify and organize the parts also makes them familiar so you will understand what the instructions intend* as you read ahead.

- Plan ahead so you know where you are going
- Read ahead so you know how to get there
- Paint ahead so the parts will be ready when you need them



Supplies:

Paint: Interior semi-gloss latex paint... Everything gets at least one coat before assembly - get the paint now.

Paintbrushes 1" or 2" foam brushes for each color, 3" foam roller for interior painting

Sandpaper: 320 grit, 3-5 sheets

Glue: Aleene's Tacky Glue for the dollhouse, Solvent-Based panel cement for shingles

Masking tape: 3/4" or 1"

Wiring: it's easiest to install some parts during assembly... order wiring supplies now.

Screwdriver: #1 Phillips

Wallpaper paste: Grandma Stovers or Roman's "Border" Paste

Not suitable for children under 13 years of age
California 93120 compliant for formaldehyde phase 2



www.realgoodtoys.help

Options for building the Victoria's Farmhouse Dollhouse at: www.realgoodtoys.com

Exterior:

Exterior Paint Color:
see www.realgoodtoys.help for suggestions

Accessories:

- Gingerbread
- Flower Boxes
- Foundation Stucco Grit
- Octagonal Shingles
- Fancy Windows and Doors
- Turnposts and Spindles

Interior:

- Wiring
- Wallpaper
- Interior paint color:
- Ceilings
- Painted walls
- Interior trim



LM5:
A Dollhouse for your Dollhouse

Flooring:

- Faux-wood finish (do it now)
- Applied wood, tile, or carpet
- Painted floors
- Banister & Landing Rails
- Window and Door trim
- Baseboard and Crown

Doors:

Exterior

Interior



#6002



#6018



#6022



#1015

Note: I often enlarge an interior door opening to fit the #6022

Windows: fit full-size single and double cutouts on the front of the house only available working or non-working



#5042



#5015



#5041



#5037

Split Octagonal Shingles

White Pine or Red Cedar



SC: Copper Flashing

Shingle Dye



Dye1: Reddish Brown
Dye3: Dark Grey



Real Good Toys' #7999
Bigger Best! Dollhouse Wiring Set



T-10
Turntable

Trim and Stripwood

- Flute24
- SW16

RGT8



Wallpaper
P2000
HH444



#4017 Pine Stair and Landing Set



6803 Banister & Landing Set

Overview of the Build:

Details of each step will be expanded along the way, but lots of folks like to see how it all fits together before they start.

Identify and label all of the parts

Pre-Assemble: Front Steps, Chimney, Bay Wall Sets,

Foundation, and the Top Floor/Gable Floor

Paint everything* one coat (see page 8)

Option: Faux-wood floor finish on the floors

Sand everything until the paint is smooth, transparent, and some of the wood is showing through

Second-coat the Walls, and the porch sections of the Floors

Option: Add an Electrification Slot to the Base Floor

Build the housebody up to the Attic Endwalls and Gable Triangle

Optional: Start the wiring

Mark, paint, and attach the Roofs (but not the Rear Roof)

Optional: Attic wiring

Install the Dividers (but not the Blind Dividers)

Optional: Finish the wiring

Assemble and finish painting everything else

Finish the Attic - attach the Rear Roof

Finish the outside

Finish the inside

Assembly Tips:

A large, clutter-free, well-lighted work area is helpful during assembly, but a flat work surface is essential.

Read the instructions carefully; look at each of the illustrations. !With the parts in your hands!, think the assembly through before you proceed.

Test fit each time you are ready to glue a piece in place... then you'll know you have it right.

If more tape or a helper is needed, it's good to know that before the parts have glue on them.

Don't be stingy with glue or tape; use generous amounts.

Always wipe off excess glue immediately.

Keep one damp rag and one dry rag handy all the time.

Have weights available for holding things tight as glue joints dry (stacks of books, gallons of pure Vermont Maple Syrup, milk jugs filled with sand - anything heavy)

Glue the body of your dollhouse together with white, water clean-up glue that dries clear. Do not use instant-bond (super glue), fast-tack, rubber cement, silicone, urethane, or hot melt glues. They can all be used on wood, but they all have some characteristic that makes them undesirable for the body of your dollhouse. Carpenter Glue works well, but glue-smear dries yellow or tan; many of the things you glue onto the house are pre-painted – extra glue will show. I use Aleene's Original Tacky Glue® (in the bronze bottle) for all house body assembly.

Make sure everything is straight and flat as glue dries...

That's the shape that will be permanent.

Slideshows, demos, useful links, details, and photos are all at:

www.realgoodtoys.help

Glue the shingles on with glue that doesn't have any water in it! If the glue says "water clean-up", it will curl the wooden shingles. Look carefully at the glue you intend to use to be sure it is solvent-based, or use hot-melt glue (and watch out for the burns). Check ingredients and warnings! Solvent-based glues say "Caution, Flammable".

If you Wallpaper, use Yes® craft paste (for bookbinding or collage) or pre-mixed Roman's "Border" paste.

Brush paste on the wallpaper, then the wall, and finally smooth the wallpaper into position.

Taking things apart: Heat softens glue. If you have to take things apart, warm the part in the oven at 170° for up to a half hour to let the heat get into the joint where the glue is. Don't let it get hotter than you can touch or the paint may scorch. Don't heat window panes.

When glue is drying, skip ahead to up-coming assembly steps and prepare the parts that will be used

Before you begin, read the "Finish the Inside" section on the last page.

Q: Can I wallpaper before I assemble the doll house?

A: Yes you can (it's your house!) Many experienced builders are advocates of papering before construction - I am not.

My biggest objection to papering first is that you are always too skimpy with glue so none will squeeze out and get on the paper. I try to use the amount of glue that fills the joint, so some will squeeze out in every joint and be wiped up. But wiping glue off of wallpaper leaves a streak, so the temptation is to go skimpy, and the joints aren't as strong.

Second, I can always tell a house that was pre-papered because the corners show a void instead of being continuous (see the slideshows about how to crowd the papers together in the corner... you can't do that with pre-papered walls).

Third, I have had to replace paper too often that has gotten damaged by glue or tape during construction... that wastes time and paper (\$) and can make it so you are left deciding whether to replace a damaged paper or letting it slide because you don't have any more of that pattern and you'll have to order it and that takes too much time (running out but then needing another piece is a distressing moment).

Finally, I don't find pre-papering to be faster. By the time I have done all of the extra planning that getting the papers in the right place requires, I have used up any potential advantage. I have great big blacksmith's hands, and papering in a finished house is easy for me.

All that having been said, I do pre-cut the papers used in the attic before attaching the Roofs and I paper in front of the Blind Dividers (2 1/2") before I glue them in place.

Identify the parts: Open one bundle at-a-time. Measure each part and find it on the parts list. Label the parts and group them by the 'instruction section #' at the end of each part's name(#). These groups are how the parts will be used.

Loose Parts:

- (2) E8130 Front/Back Foundation¹: (1/2) 33 x 13/4
- (4) E8131 Middle Foundation¹: (1/2) 18 3/4 x 13/4
- (2) E9801 Bottom Stair Block¹⁰: (6Step) 2 1/4
- (2) E9802 Top Stair Block¹⁰: (6Step) 2 1/4
- (1) E8104 Gable Left Roof²: (1/4) 14 1/8 x 14 1/8, Bev.
- (1) E8103 Gable Right Roof²: (1/4) 14 1/8 x 14 1/8, Bev.
- (2) E8128 Attic Endwall²: (3/8) 10 5/8 Tall x 15 1/8 Base, Groove
- (1) E8127 Gable Triangle²: (3/8) 10 5/8 Tall x 15 1/8 Base, Groove
- (1) E8129 Attic Partition¹⁰: (3/8) 10 1/4 x 9 1/4 Base
- (2) E8110 Gable Right Side^B: (Clapboard) 9 x 5 3/4
- (1) E8118 Top Floor¹: (3/8) 28 x 14 1/2, Stair hole
- (4) E8125 Divider¹⁰: (3/8) 9 x 2 1/2
- (2) E8133 Eave²: (1/4) 12 x 2
- (1) E8101 Front Roof²: (1/4) 30 1/2 x 14 1/8, Cutout
- (1) E8102 Rear Roof²: (1/4) 30 1/2 x 2, Bev.
- (3) E8105 False Eave⁶: (1/4) 1 1/2 x 15 3/4, Bev.
- (1) E8132 Gable Foundation³: (1/4) 14 x 13/4
- (1) E8106 Access Bay Roof⁴: (1/4) 8 x 13/4, Bev.
- (1) E8119 Middle ("Mid") Floor¹: (3/8) 33 1/4 x 20, Stair hole
- (1) E8120 Base Floor¹: (1/4) 33 1/4 x 20

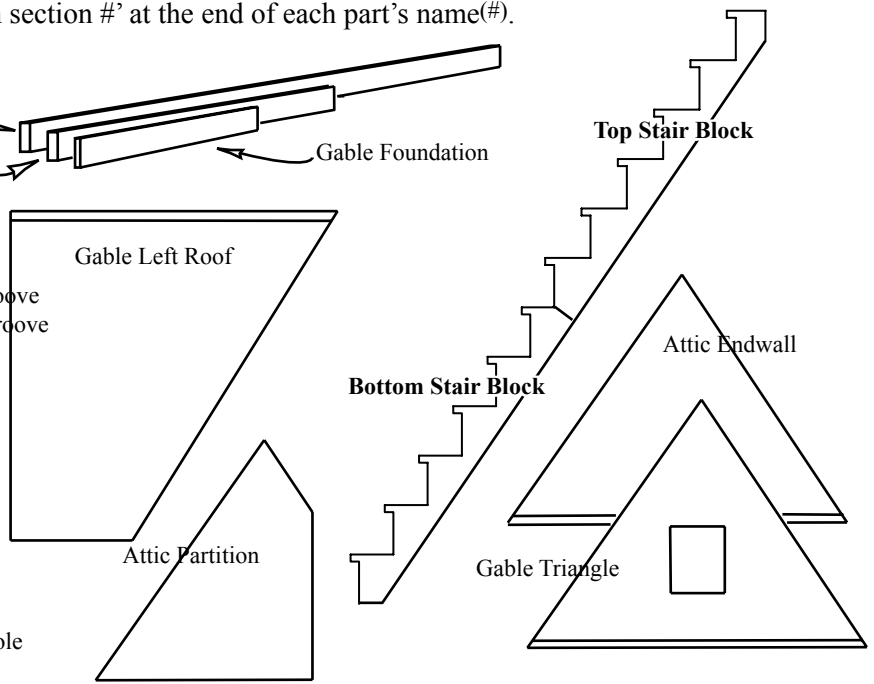

Panels Bundle:

- (1) E8122 Gable Top Floor¹: (3/8) 14 1/2 x 5 3/4
- (1) E8111 Access Bay Front^B: (Clapboard) 17 1/8 x 6 7/8, Cutouts
- (1) E8114 Lower Right Front^B: (Clapboard) 9 x 13 1/8, Door&Window Cutout
- (1) E8115 Upper Right Front^B: (Clapboard) 9 x 13 1/8, Window Cutout
- (1) E8123 Access Bay Middle Floor¹: (3/8) 1 x 6 1/4
- (1) E8141 Access Bay Spacer¹: (3/8) 1 1/2 x 6 1/4
- (1) E8107 Left Side^B: (Clapboard) 18 19/32 x 10 5/8, Grooved
- (2) E8142 Access Bay Sides^B: (Clapboard) 17 1/8 x 2 5/32
- (1) E8109 Gable Left Side^B: (Clapboard) 18 19/32 x 3, Grooved
- (2) E8126B Divider¹⁰: (3/8 mdf) 9 x 14 1/8, Door
- (6) E8138 Bay Vertical^A: (3/8) 9 7/32 x 3/4, Bev.
- (1) E8112 Lower Right Side^B: (Clapboard) 9 x 14 1/2
- (1) E8113 Upper Right Side^B: (Clapboard) 9 x 14 1/2, Cutout
- (1) E8108 Gable Front^B: (Clapboard) 18 19/32 x 14 1/2, Grooved, Cutouts

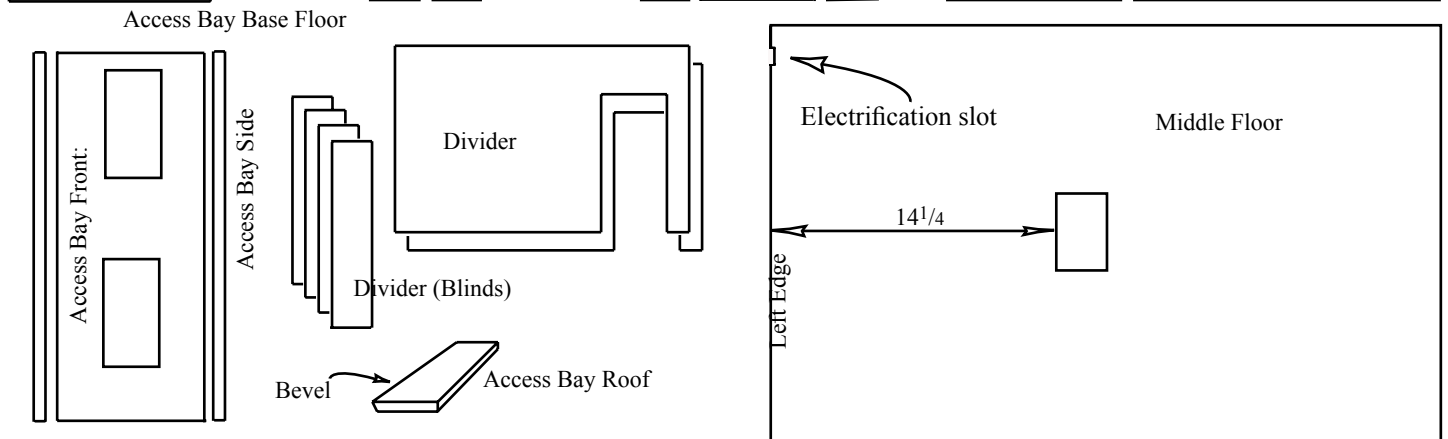
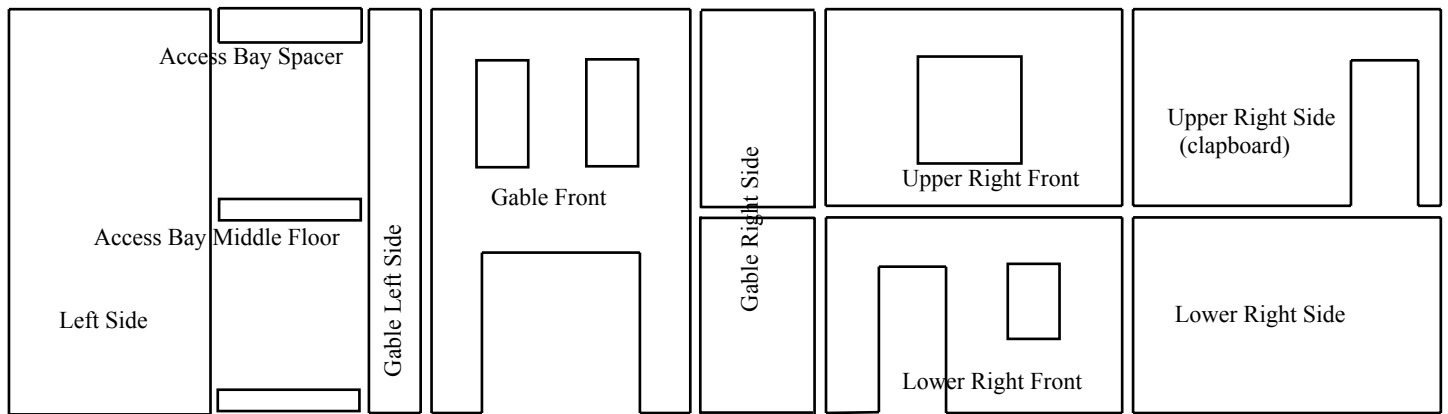
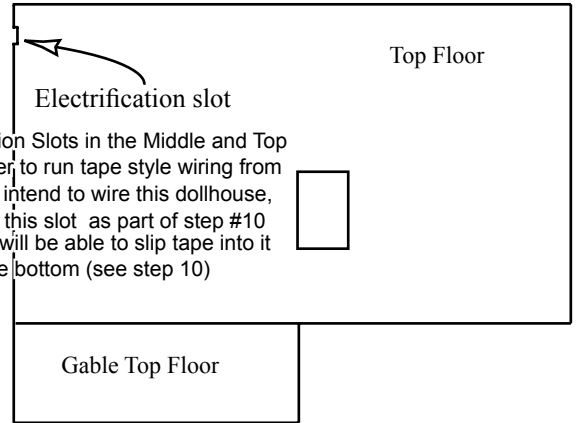

Box "A"

- (1) E8139 Front Step^A: (5/8 mdf) 5 x 2
- (1) E8140 Front Step^A: (5/8 mdf) 5 x 1

AccessBay Hardware Bag⁴:

- (2) E8168 1" Hinge
- (8) E8169 3/8 #2 Screws
- (1) E8124 Access Bay Base Floor¹: (1/4 mdf) 1 x 6 1/4
- (1) E8136 Access Bay Ceiling⁴: (3/8 mdf) 7 x 1 1/4, Bev.
- (2) E8134 Bay Side Foundation³: (3/8 mdf) 3 1/4 x 1 3/4, Bev.
- (1) E8135 Bay Front Foundation³: (3/8 mdf) 4 5/8 x 1 3/4, Bev.
- (4) E8116 Bay Side^A: (Clapboard) 2 3/32 x 1 3/4
- (2) E8117 Bay Front^A: (Clapboard) 2 3/32 x 3 1/2
- (1) E8121 Bay Base Floor³: (1/4 mdf) 2 21/32 x 7 1/4, Mitered
- (1) E8137 Bay Top³: (3/4 mdf) 3 15/16 Wide x 10 13/16, Molded
- (1) E8143 Chimney Block^A: (1 1/2 mdf) 5 3/8 x 2 1/2
- (1) E8144 Chimney Cap^A: (1/4 mdf) 2 1/2 x 1 1/2
- (1) E8145 Chimney Cap^A: (5/8 mdf) 2 3/4 x 1 3/4
- (1) E3626 Flower Box⁹: (1/2) 3/4 x 3 1/2, Mitered
- (2) E9803 Stringer¹⁰: (1/8 x 1 3/16 mdf) 10 7/8, Mitered
- (1) E8170 (575) Shingles^A

Box "B"

- (2) 6042 Assembled Door⁶
- (1) E8170 (575) Shingles^A

bag⁵:

- (6) E8160 Window Frame 3 3/4 miter 45°/45°
- (12) E8156 Window Frame 2 3/4 miter 45°/45°
- (4) E8164 Window Frame 1 15/16 miter 45°/45°
- (20) E3633 Shutter Panel (1/16 x 3/4) 1 7/8

bag⁵:

- (18) E8155 Window Frame: 5 1/4 miter 45°/45°
- (2) E8159 Middle Frame 4 7/16
- (2) E8161 Trim (1/16 x 3/8 pine) 4 9/16
- (2) E8158 Spacer 1 15/16"
- (2) E8165 Spacer 1 3/16

bag⁵:

- (6) E8157 Standard Pane (Printed Plexi) 4 5/8 x 2 1/8
- (2) E8162 Short Pane (Printed Plexi) 3 1/32 x 2 1/8
- (4) E8163 Narrow Pane (Printed Plexi): 1 5/16 x 4 5/8

bundle⁵:

- (4) E8166 Short Window Shutter Core (1 x 1/8) 3 1/8
- (10) E3632 Std Shutter Core (1 x 1/8) 4 5/8

- (12) J0644 Interior Window Trim (3/32 x 3/8) 2 27/32 angled/
- (18) J0645 Interior Window Trim (3/32 x 3/8) 5 11/32 angled/
- (6) J0642 Interior Window Trim (3/32 x 3/8) 3 23/32 angled/
- (4) J0643 Interior Window Trim (3/32 x 3/8) 2 angled/
- (2) J0640 Interior Door Trim (3/32 x 3/8) 3 11/32 angled/
- (4) J0641 Interior Door Trim (3/32 x 3/8) 7 11/16 angled/

bag:

- (148) E3622 1/8 Dowels⁹: 1 3/4
- (4) E3960 3/8 Beads⁹
- (4) E8150 Balcony Post⁹: (1/2 Flutepost) 2 3/8
- (4) E8167 Short Window Shutter Panel⁵ (1/16 x 3/4) 2 5/8

bag:

- (4) E3619 Porch Post: (1/2 Flutepost) 9
- (4) E8151 Porch Rails: 4 3/4
- (2) E8152 Porch Rails: 6 3/16
- (8) E8153 Porch Rails: 9 5/32
- (4) E8154 Porch Rails: 11 5/8

Trim Box 7 & 9

- (7) E8146 Trim: (1 x 1/8) Over 2 31/2
- (7) E3689 Trim: (3/4 x 3/32) Over 2 31/2
- (1) E8147 Trim: (1/2 x 1/8) Over 2 31/2
- (8) E3966 Trim: (1/2 x 3/32) Over 2 31/2
- (9) E8148 Trim: (3/8 x 3/32) Over 2 31/2
- (11) E8149 Trim: (3/16 x 3/32) Over 2 31/2

Cross section of Trim

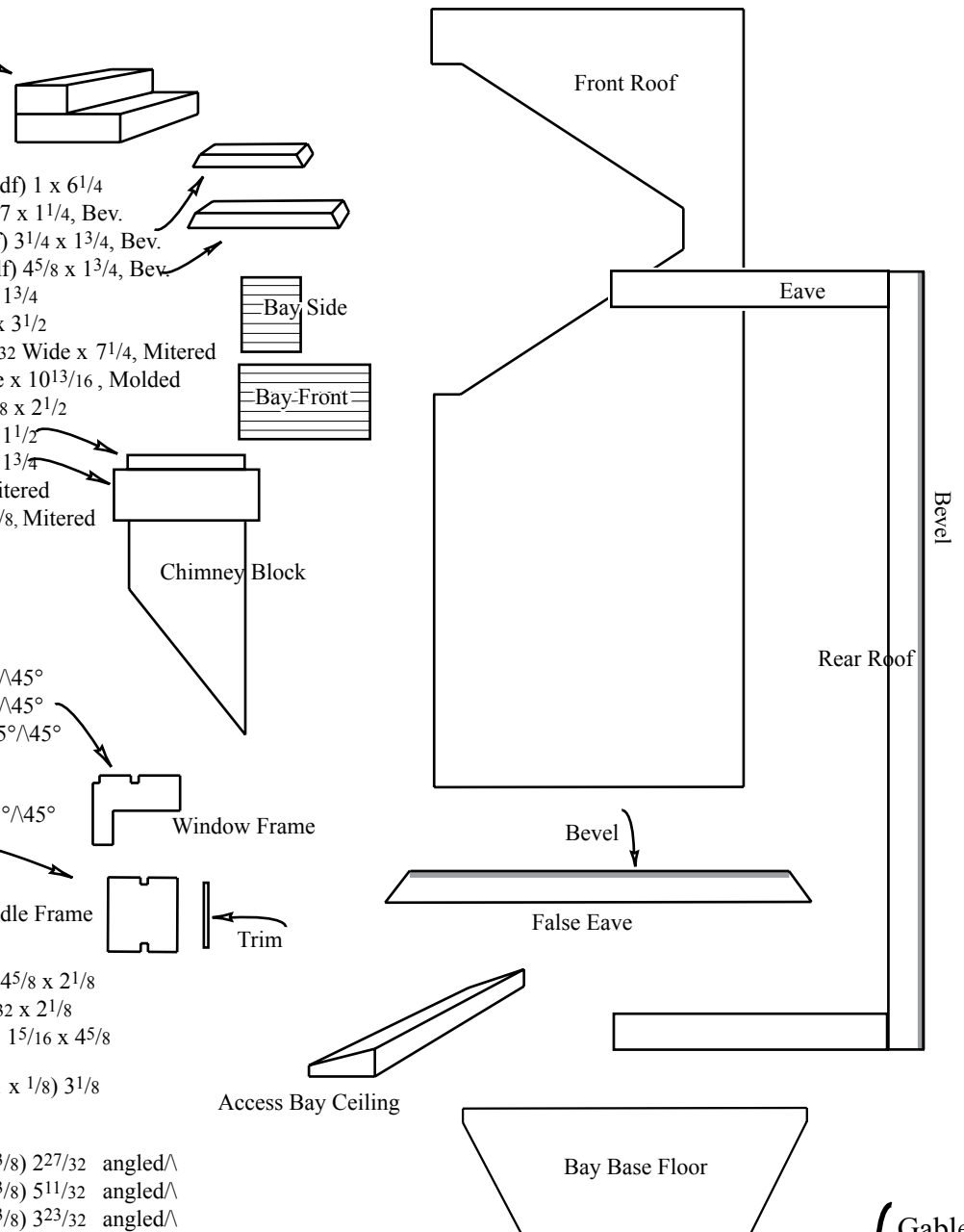

AccessBay

Bay

A: Getting Started: Do these things before the house assembly

Square the corners of the window, door, and stair holes with a utility knife - each cutout has a rounded corner left over from the tool that made it. Make two cuts in each corner from the outside (one from each direction), then cut from each direction on the inside to cut away the rounding in the corner so the window, door, or stairs will fit.

A Double-Cut Coarse file is easier for many people to use when squaring the corners. Make several strokes from each direction in each corner and test the Window or Door to see how it fits.

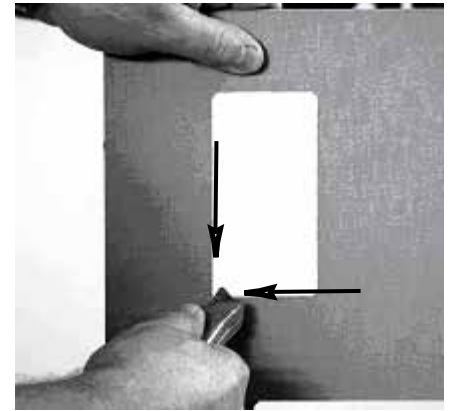

Stain the Shingles: Our pro uses Real Good Toys' Shingle Dye (available through your Real Good Toys miniature dealer) when dyeing the shingles for this house. Batch dye or stain the shingles several days ahead of time so they will be dry when the time comes to use them (instructions are with the shingle dye).



Pre-Assembly

1. **Assemble the Front Steps** ($\frac{5}{8}$ mdf) 5 x 2 and 5 x 1: Glue together the Front Steps lined up on the back edge and both ends

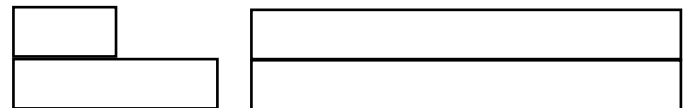

2. **Assemble the Chimney:** Glue together the Caps, centered. Turn the Caps up-side-down; glue the Chimney Block to the Caps, centered.

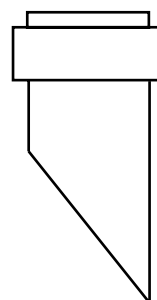

3. **Assemble the Bay Wall sets;** each set is 2) Bay Verticals and 2) Bay Walls ($1\frac{3}{4}$ or $3\frac{1}{2}$ " long) The clapboard profile is on the outside. See page 12

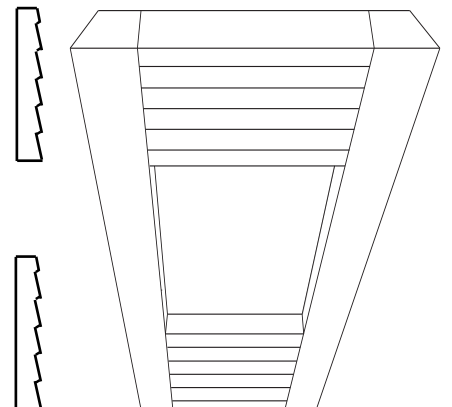

view from the top

Make two Bay Side wall sets

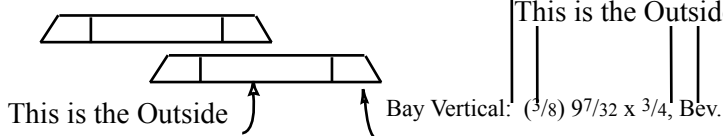

Make one Bay Front wall set

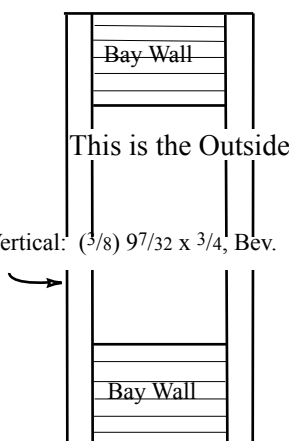
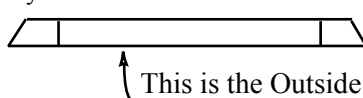

The wider face is the outside



Can I do it differently? Yes you can - it's your house!

The information on these pages is offered as "best practices" advice, and it is what we do when we build this house. But if you are customizing or have something else in mind, test-ahead to make sure your planning includes *everything!*

For many photos of the build go to www.realgoodtoys.help and click on "JM1065"

- 4 A. Glue and tape together the Foundation perimeter. The Front and Back overlap the Sides
- B. Install the Middle Foundations spaced evenly (a bit under $\pm 10^{5/16}$ ") from each other.
- C. Glue and tape on the Gable Foundation - this becomes the front-left corner of the Foundation.

Step 4C
Attach the Gable Foundation lined up on the left

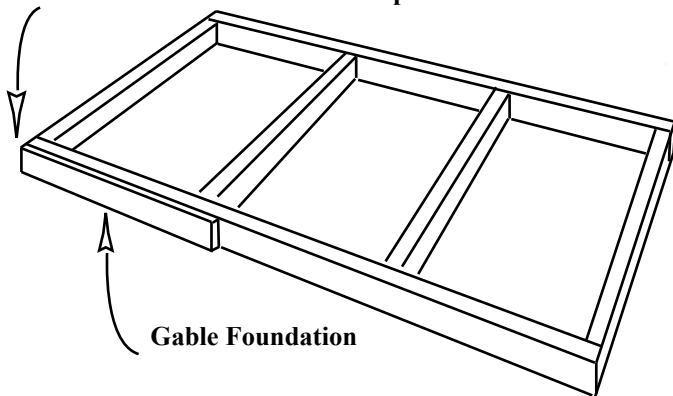

Step 4A
Front/Back Overlap the Sides

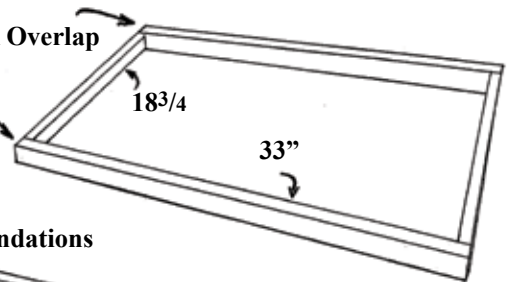

Step 4B
Install the Middle Foundations

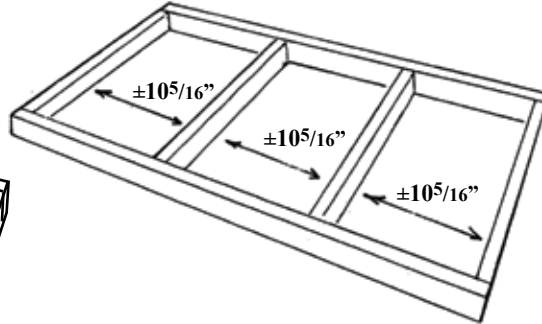

See 'step 1' on page 8 - make sure the Foundation is flat, straight, and square as the glue dries

In step 5, you are marking the Porch floor and ceiling for painting using the Top Floor as a template. But, the left edge of the Top Floor doesn't line up with the left edge of the Middle Floor or Base Floor (the Top Floor overlaps the walls, while the lower floors fit into grooves), so the stair hole will be used as a side-to-side reference instead of the left edge.

- 5. A. Identify the top and front edges of the Top Floor ($(3/8)$ 28 x $14^{1/2}$) - the Gable Top Floor ($(3/8)$ $14^{1/2}$ x $5^{3/4}$) shows the spacing from the left edge to the stair hole ($14^{1/2}$ "), and the stair hole is closer to the front edge. Glue and tape the Gable Top Floor to the front edge of the Top Floor, lined up on the left

- B. Identify the left edge of the Mid Floor - the stair hole is spaced $14^{1/4}$ " from the left edge, and $16^{3/4}$ " from the right edge (looking from the front). Set the Mid Floor on the Base Floor, lined up on the edges. Very lightly trace the left and right edges of the stair hole onto the Base Floor. Remove the Middle Floor.

- C. Set the Top Floor/Gable Floor on the Mid Floor lined up at the back edge and lined up side-to-side at the stair holes (the left edge of the Top Floor will overhang $1/4$ " on the left edge). Trace the Top Floor/Gable Floor perimeter onto the Mid Floor. This tracing is the outside edge of the right walls - outside the tracing is the Porch Floor. Trace the Top Floor/Gable Floor onto the bottom surface of the Mid Floor. This tracing is the Porch Ceiling (make sure the tracings line up with each other)

- D. Set the Top Floor/Gable Floor on the Base Floor lined up at the back edge and lined up side-to-side with the stair hole tracing (the left edge of the Top Floor will overhang $1/4$ "). Trace the Top Floor/Gable Floor perimeter onto the Base Floor.

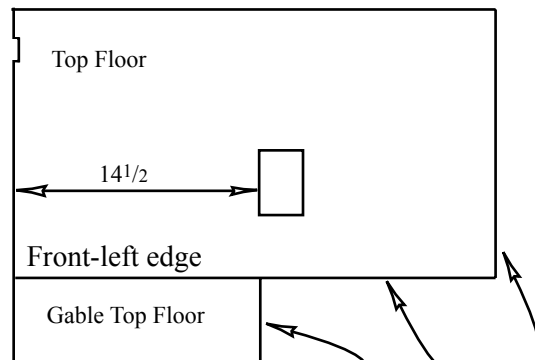

This edge... is traced here

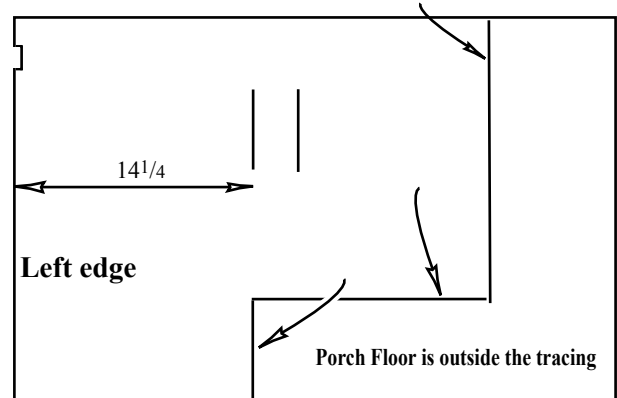

Painting: www.realgoodtoys.help has painting and sanding videos

Paint (first-coat) everything*. Don't try to sand, fill, primp, or do much of anything to the wood before the first coat. The first coat fills and reinforces the wood so sanding clips off the fibers rather than pushing them around. The first-coat is all about what penetrates and fills the wood. There is no expectation that more than a hint of paint will be on the surface. Don't 'double paint' or try to give it an extra thick first coat as you watch the paint soak in... that is expected and preferred. ☞ Don't paint edges or surfaces that will be glued (like the edges of the walls or the outsides of the roofs). ☞ The first benefit of painting before assembly (one-coat) is that it is the easiest time to do a really thorough job of sanding after painting. The difference between a heirloom-grade finish on a dollhouse and a "I-was-in-a-hurry" finish is most often the quality of the sanding, and it's hard to sand into the little hidden corners of an assembled dollhouse, but it's easy to sand the flat panels layed out on a workbench. So sand everything now - sand until the paint is smooth and transparent with no scratchiness to it, and with lots of wood showing through the paint. For the clapboard walls, sand "one clapboard course at-a-time": fold the sandpaper and hold it on your finger-tips, then sand back-and-forth across one clapboard's surface 2 or 3 times, then move up to the next clapboard. "One at a time" is what makes it smooth and "Heirloom-Great".

The second coat goes on smooth and creamy, and except for touchup, it may be enough. Second coat the walls and porch sections. Wait to second coat the railings and windows.



First-coat



Sanding one course at a time

If you are wiring this house, I recommend the #7999 wiring set, which uses a Jack and Plug in the foundation to connect the house to the Power Supply. If so, cut an Electrification Slot in the edge of the Base Floor, using the Middle Floor as a guide, and on the top of the Foundation that lines up with the Base Floor Slot. See www.realgoodtoys.help for a slideshow.

Assemble the Housebody

1. Glue, tape, and weight the foundation set to the housebody's Base Floor; flush at the back and along the left edge. The floor overhangs $\pm 1/4"$ at the front and right edges where you've painted for the porch. You may have to flex the Foundation into position... this is the step that straightens the Foundation.

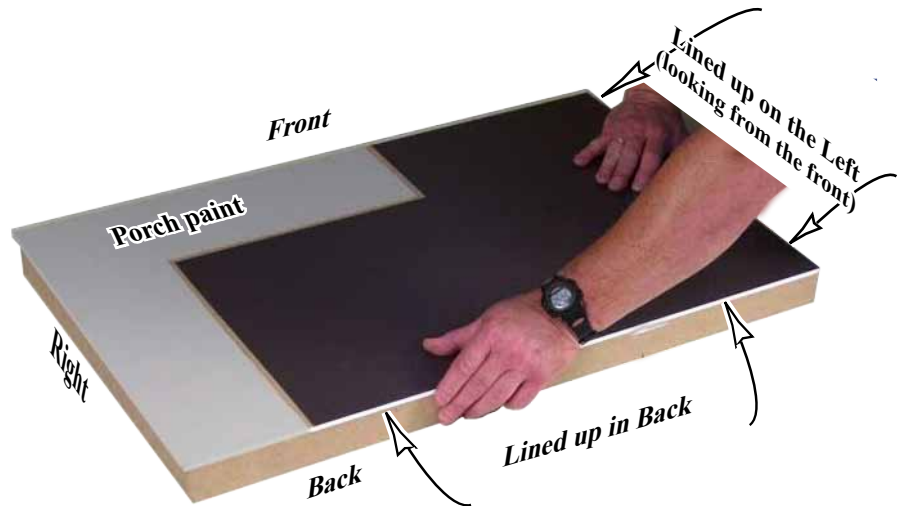

Caution: Look at the Foundation and Base Floor several times before leaving it to dry... the overhang is where you painted for the Porch.

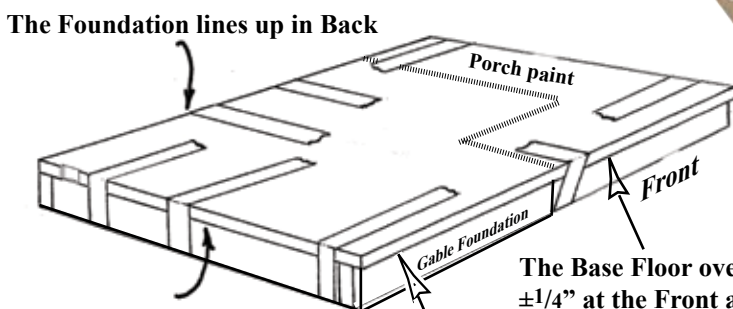

The Foundation lines up on the left edge

The Base Floor lines up with the Gable Foundation in front

The Base Floor overhangs $\pm 1/4"$ at the Front and Right edges (view from the Front) where the porch is painted

"Right" and "Left" are from the front of the dollhouse

Test the Floors in the grooves of the Left Side, Gable Left Side, and Gable Front. See www.realgoodtoys.help

2. Glue and tape the Gable Front to the Gable Left Side panel (the Front overlaps the Side), with the grooves perfectly lined up (use a divider to make sure the grooves line up) see Illustration #5. Let the glue dry.

Illustration #5
Gable Front Overlaps the Gable Left Side

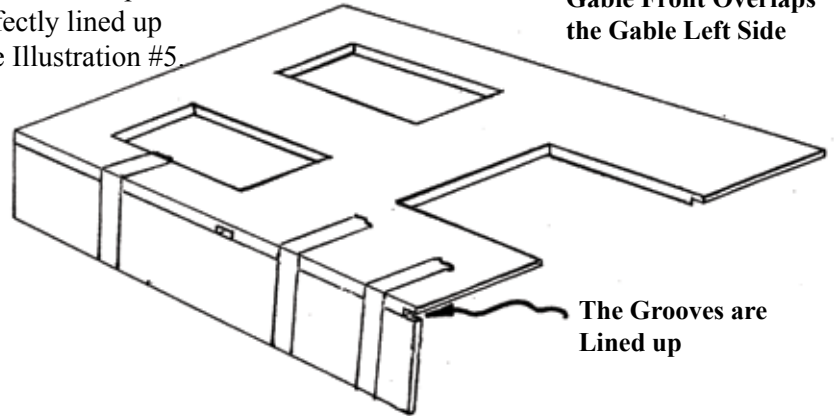

3. Glue and tape the Gable Front and Gable Left Side assembly to the Base Floor, straight and tight (Illustration #6). The Base Floor sets into the Base Floor's groove in the walls

Use lots of tape to pull the Floor tight into the grooves.

Illustration #6
Glue and tape the Gable Front & Gable Left Side to the Base Floor

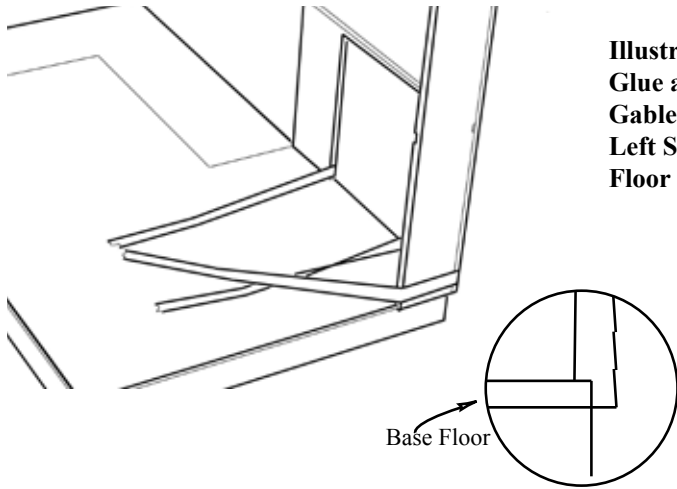
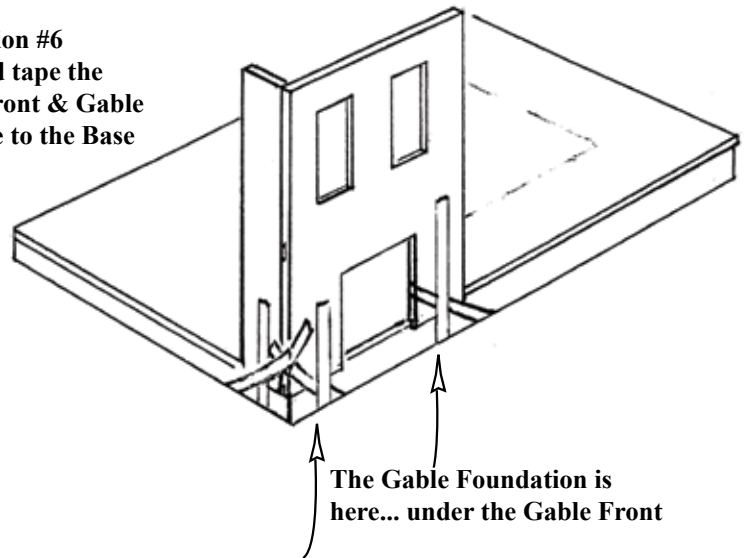

Step 4
Detail of overlaps

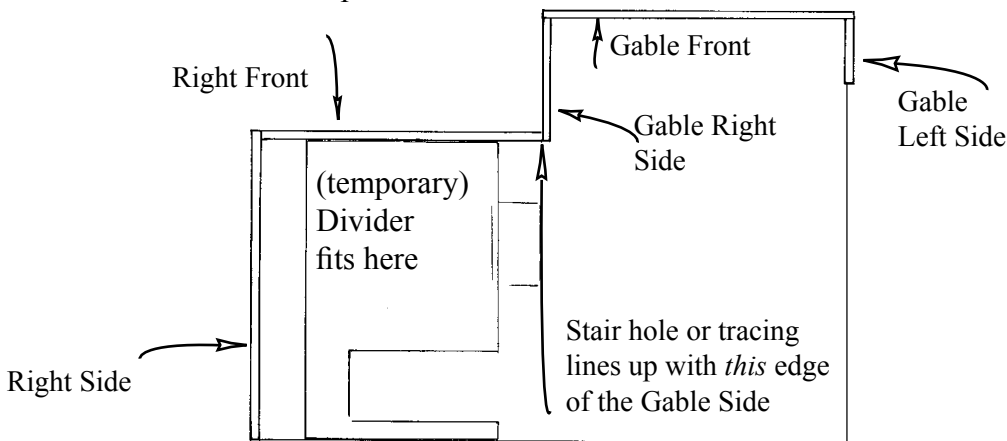
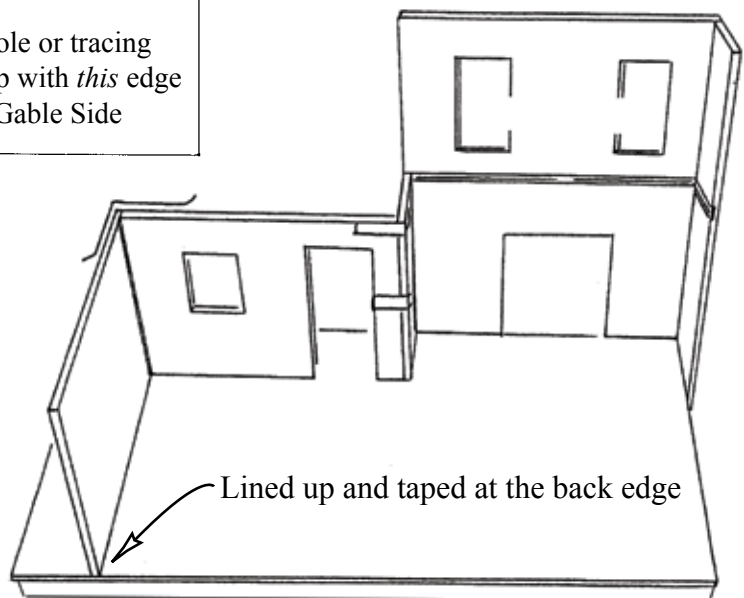

Illustration #8
Glue and Tape the 1st Floor Walls in Place

4. Glue and tape the first floor walls in place (the Gable Right Side, Right Front, and Right Side walls) following the perimeter tracing (Illustration #8).



Note: clean paint out of the grooves!

5. Test the Middle Floor in the grooves in the Gable Front and Gable Left Side. Sand the top and bottom at the edges if necessary for a good fit. Glue and tape the Middle Floor to the Walls, fully into the grooves of the Gable Front/Left Side, with the walls lined up with the ceiling tracing and flush at the back edge (Illustration #9).

6. Glue and tape the Second Floor walls in place following the tracing. Make sure the right side walls line up at the back edge, and look lined up with each other when viewed from the front.

7. Glue and tape the Top Floor/Gable Floor to the walls, lined up with all of the walls on the outside (Illus. 11). If you are going to wire your dollhouse, trace and carve the bottom of the Electrification slot to make it exposed inside the Left Side Wall (don't make it deeper at the top, just at the bottom) before gluing on the floor

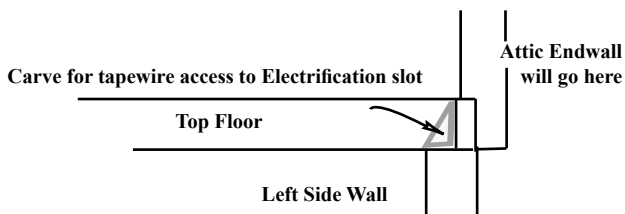

8. Glue and tape the Access Bay Spacer to the Gable Left Side and to the Top Floor (Illus #11).
Note: The AccessBay Spacer is smooth - it is hidden by other parts.

9. Glue and tape the AccessBay Mid Floor and AccessBay Base Floor to the the Middle Floor and Base Floor (Illus. 11, see also step 1, page 13)

10. Glue and tape the Housebody's Left Side to the Floors and Spacer, tight in the grooves and lined up at the back edge.

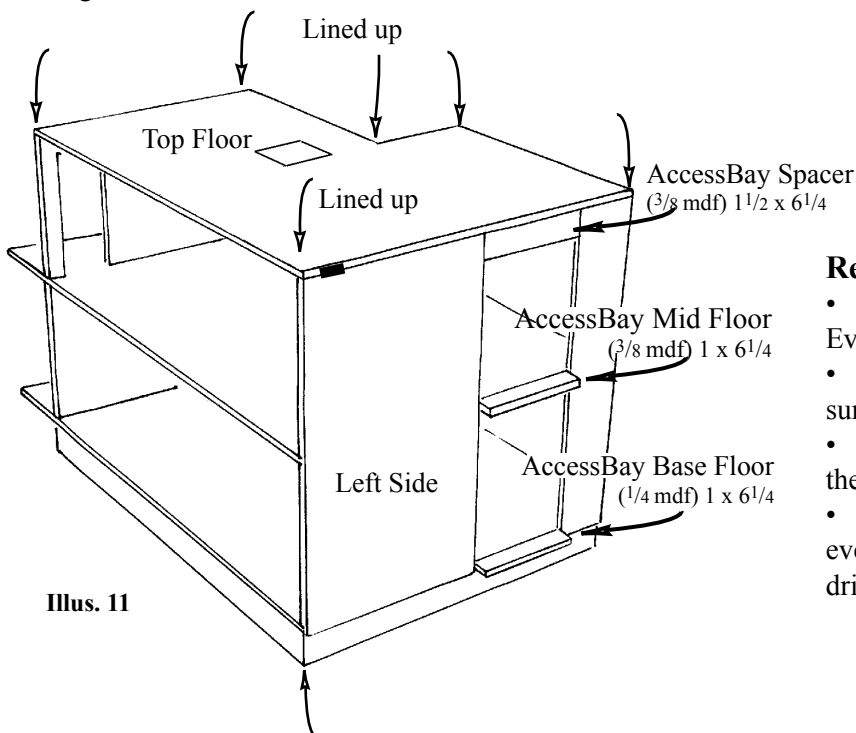
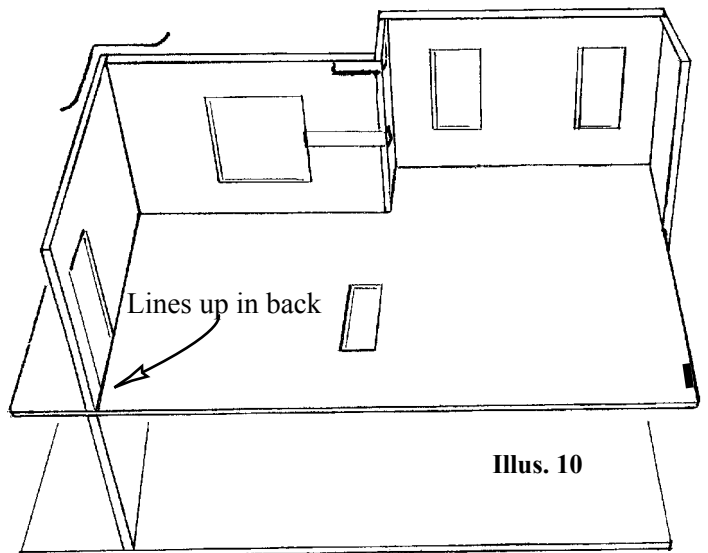
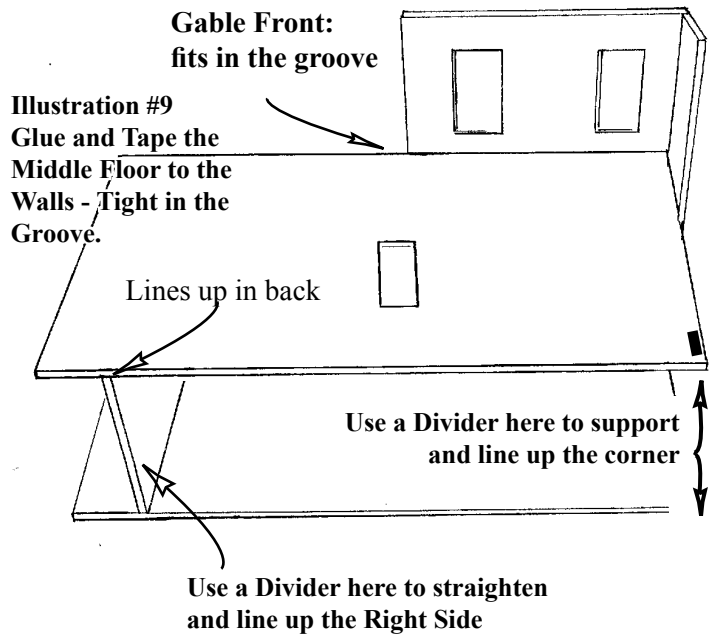

Illus. 11

Review:

- Look at the housebody from every angle. Everything should be tight and lined up.
- Make sure the housebody is on a flat surface as the glue dries.
- Prop dividers between the floors to keep them straight.
- Add weight and plenty of tape to keep everything tight and straight as the glue dries.

II. Build the Attic and Roof ...

Plan ahead:

Pre-paint (or mark, and paint as you go) any parts that will be a different color from the ones they touch. It is easiest to do some of the wiring and interior finishing in the attic before attaching the Rear Roof

There are interior finishing decisions that should be made now. For suggestions, see the "Customizing a Victoria's Farmhouse" Blog on at www.realgoodtoys.help/1065.html

1. Glue and tape the Gable Triangle and Attic Endwall Triangles to the Top Floor. Tape a Divider or Attic Partition to the Triangles to hold them straight as the glue dries (Ill. #1).

2. On the outside of the Roof Panels draw guidelines for locating Shingles. The first guideline should be drawn one Shingle length from the bottom edge. Draw the rest of the guidelines spaced 1" apart (Illustration #2 and the Guideline Measure at right). Now is an easy time to pre-cut attic wallpaper

3. Without glue, Test the Roof panels on the house. Make sure the Front Roof touches the Third Floor's edge all across the Front (particularly on both sides of the gable ... trim the cutout's inside corners for a good fit: Illustration #3).

4. *Glue and tape the Front and Rear Roofs together. The Rear Roof is beveled where the two roofs meet. Use many pieces of tape across the top, and tape around each end.

Before the glue dries, glue the roofs to the Attic Endwalls, centered side-to-side, and with the roof overhanging evenly from top to bottom. Use all the tape you need to hold the roof tight as the glue dries.

5. Glue and tape the Eaves in place on the remaining exposed top edge of the Attic Endwalls, flush at the outside edge of the Rear Roof. Look under the Eaves to check that the spacing is even (Illus. #4).

6. Tape together the Gable Roofs at the peak. Test the Gable Roofs on the house (Make sure the house Front Roof is touching the Third floor all along the front edge). Look at the fit from the inside and adjust if necessary. Mark the position of the Gable Roofs on the house's Front Roof

7. Glue the Gable Roofs to each other, the Gable Triangle, and the house's Front Roof. Add extra glue to the "V" space between the Gable Roofs and the Front Roof. Tape inside and out for a good fit.

Review: The shell of the house is all together and the panels are straight and tight. Make sure the house is flat on a flat surface as the glue dries.

Illustration #1
Glue and Tape the Gable Triangle and Attic Endwall Triangles to the Top Floor

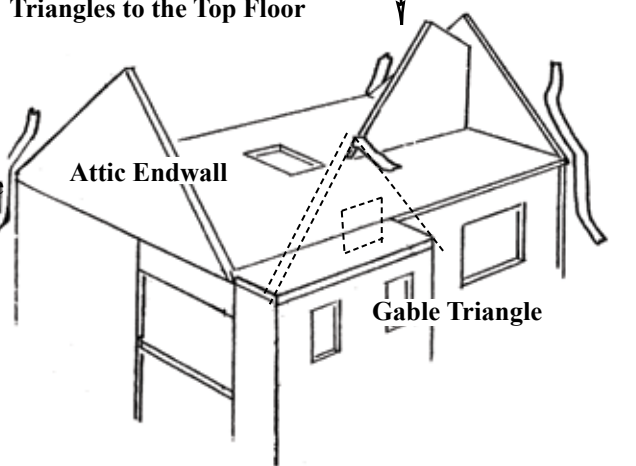

Illustration #2
Shingle Guidelines

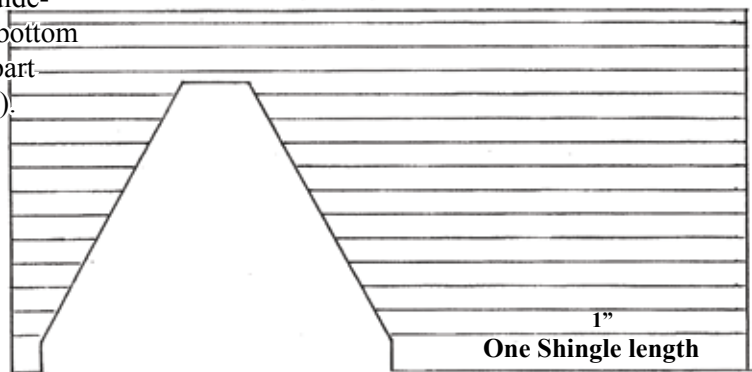

Illustration #3
Front Roof Overlaps the Rear Roof

*Note: I do not attach the Rear Roof permanently until interior finishing is done

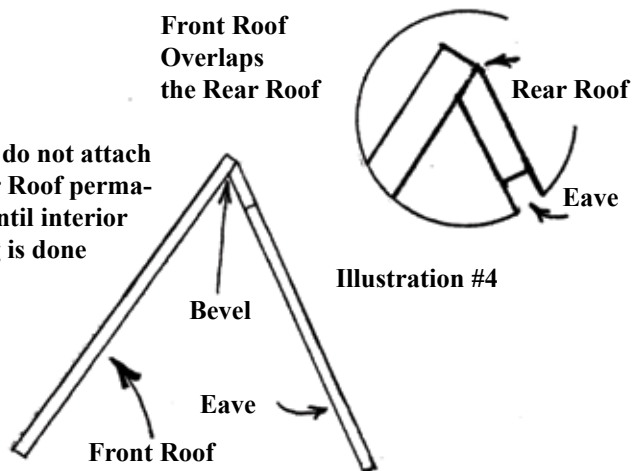
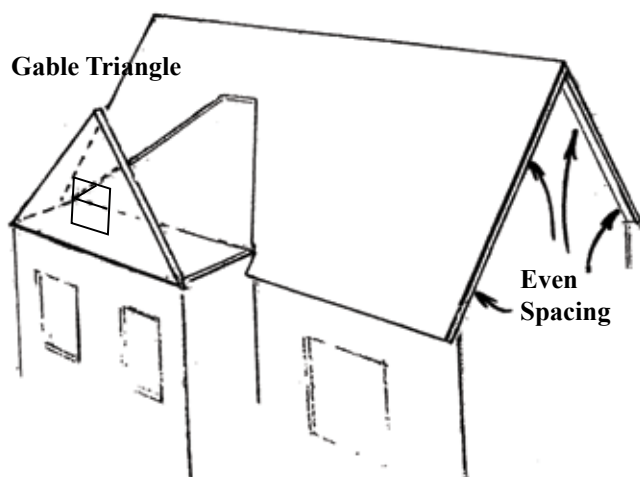

Illustration #4



Guideline Measure

1"

1"

1"

1"

1"

1"

1"

1"

1"

One Shingle Length

Exterior Painting:

Finish all of the Exterior painting now!

III. Assemble the Front Bay:

Continue to Step 4 without stopping

- 1. Glue and tape together the Bay Foundation (Illustration #1). Continue without stopping.
- 2. Glue and tape the Bay Base Floor to the front edge of the house's Base Floor, inside the bay cutout in the Gable Front (Illustration #2). Make sure the floor surface across the joint is tight and smooth.
- 3. Glue and tape the Bay Foundation set to the Bay Base Floor and to the Gable Foundation. The foundation extends past the Bay Base evenly on all edges (this is a ledge to hold the bottom of the Bay Walls).

Illustration #1
Glue and Tape Together the Bay Foundation

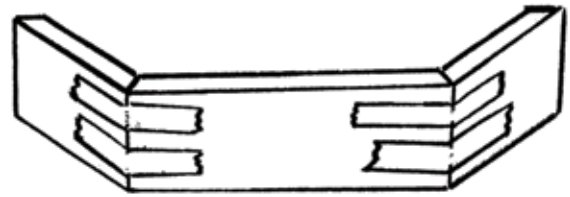
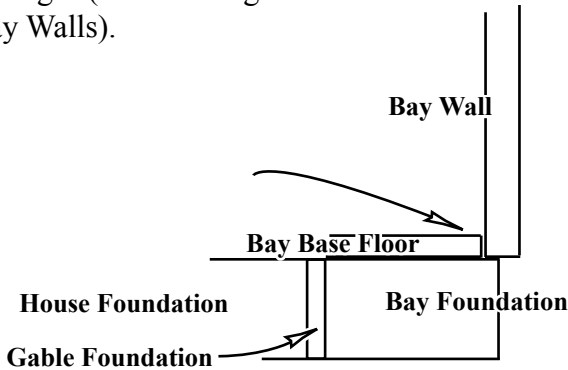
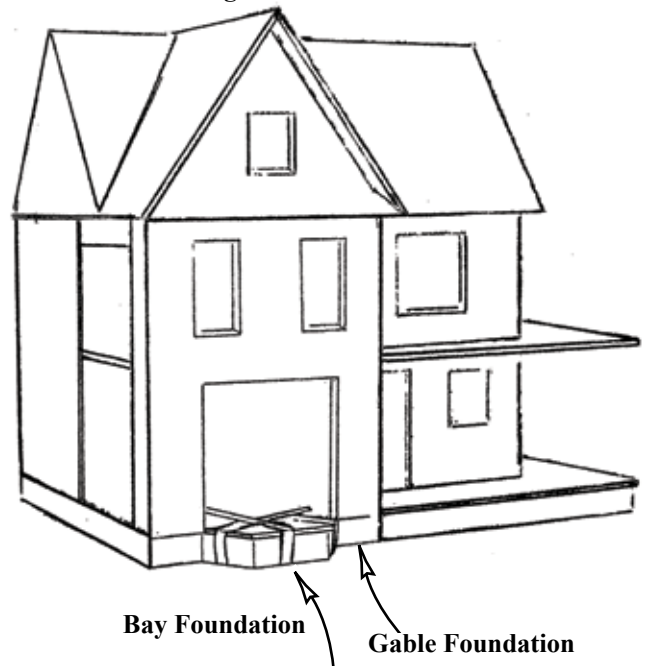

Illustration #2
Glue and Tape the Bay Base Floor to the Front Edge of the House's Base Floor



- 4. Tape the Bay wall sets together at the corners (Illustration #4). Test them on the house wrapped around the Bay Floor, and adjust if necessary. Glue the Bay walls together, to the Bay Base Floor, and to the foundation (Illustration #5).

- 5. Glue and tape the Bay Top to the housebody and Bay, spaced evenly all around (pg 1 photo).



Illustration #5
Glue the Bay Walls Together, to the Bay Base Floor, and to the Foundation

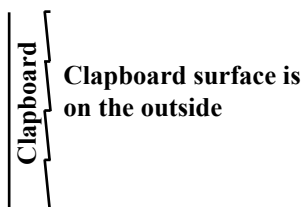
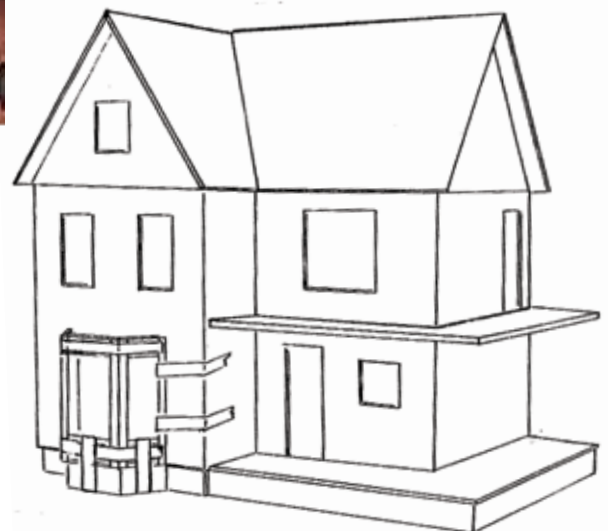
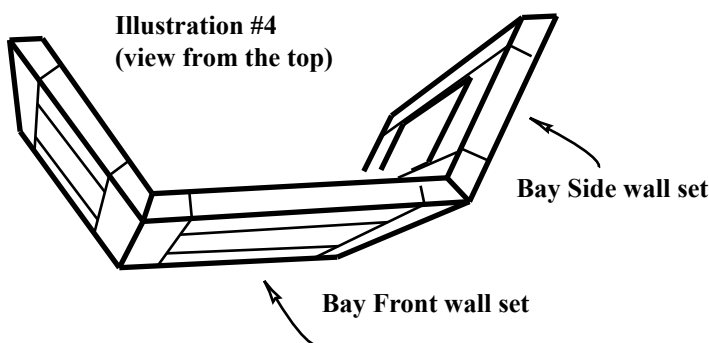

Illustration #4
(view from the top)



IV. Assemble the Access Bay:

The Access Bay allows the decorator access to the gable's front rooms.

1. (this may already be done) Glue and tape the Access Bay Floors to the housebody's floors, tight and straight. Dividers between the Access Bay floors help to keep the floors lined up (Illustration #1).

2. Prepare for Attaching the Hinges:
Preview: In this section, you will temporarily install the hinges for the Access Bay Front and Access Bay Left Side. You are doing this now so you can work flat on the table where you can hammer and drive screws more easily than inside an assembled house.

Make sure your #1 Phillips head screwdriver is in new condition.

Check that the hinge can open a bit more than 3/4 of the way around (this helps the Accessbay Front from being "springy" when it closes) - give it a squeeze if necessary to open the hinge as shown.

3. Check the clapboard profile on the Access Bay Front and Access Bay Side to identify the base end of each of those panels. Mark the base end so that even when the clapboard surface is on the work table, you can tell that the base end is at the bottom (Illustration #2).

4. Lay the Access Bay Front face down with the clapboard surface on the work table.

5. Tape two hinges on the Front Panel with the pins down and hooked on the edge, one hinge spaced 1" from the top, and the other spaced 1" from the bottom (Illustration #3).

Punch a starter hole in the center of each hole in the hinge: Drive a nail part way through the wall and pull it back out (don't go all the way through).

Builders Tip: Stick the screws in a soft bar of soap to make them turn in easier.

Start a screw in each hole (the tape will help the screw stand up). Drive the screw 1/2 way in with a hammer (hit it hard!), and the rest of the way with a #1 Phillips screwdriver.

Repeat for the other screws.

Turn the tape to cover the hinge and screws.

Add another piece of tape... this will hold the Access-Bay Front a bit away from the Side in the next step.

Illustration #1

Glue and tape the Access Bay Floors to the Housebody's Floors.

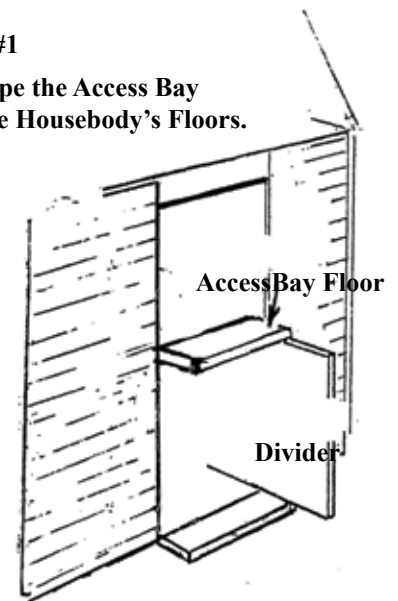

Dividers help to keep the Floors Lined Up

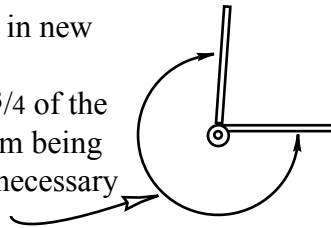
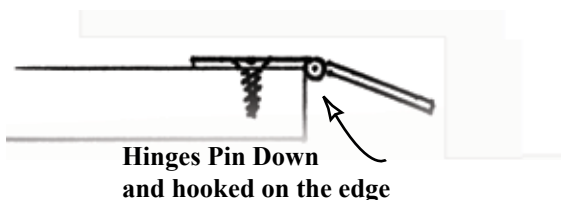
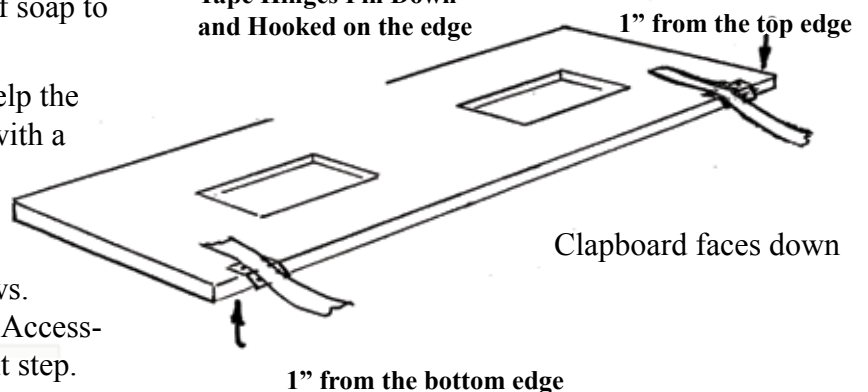

Illustration #2
Base End



Illustration #3

Tape Hinges Pin Down and Hooked on the edge



More great tips on installing screws:
www.realgoodtoys.help then click "Blog"

6. Set an Access Bay Side on the edge of your workbench with the clapboard up. Let the Access Bay Front Hang off the front of the workbench. Fold the Hinges across the clapboard surface of the Access Bay Side. Line up the top edges of the Access Bay Front and Access Bay Side (check the clapboard profile again) see Illustration #4.

Builder's tip: let the Accessbay Front hang a little bit away from the Accessbay Side so they won't be quite touching in the assembled house.

7. Tape the Hinges to the Side. Punch a starter hole and drive the screws as you did for the Front, then take the screws back out of the Front (it's easier building the house without the Access Bay Front attached).

8. Glue and tape the Access Bay Sides to the housebody's walls and Access Bay Floors (Illustration #5).

9. Glue and tape the Access Bay Ceiling to the house and tops of the Access Bay Sides, lined up on the outside.

10. Glue and tape the Access Bay Roof to the Access-Bay Ceiling, centered side-to-side (Illus. 6).

11. Hinge the Access Bay Front in place using the holes prepared in step #5.(Illustration #6).

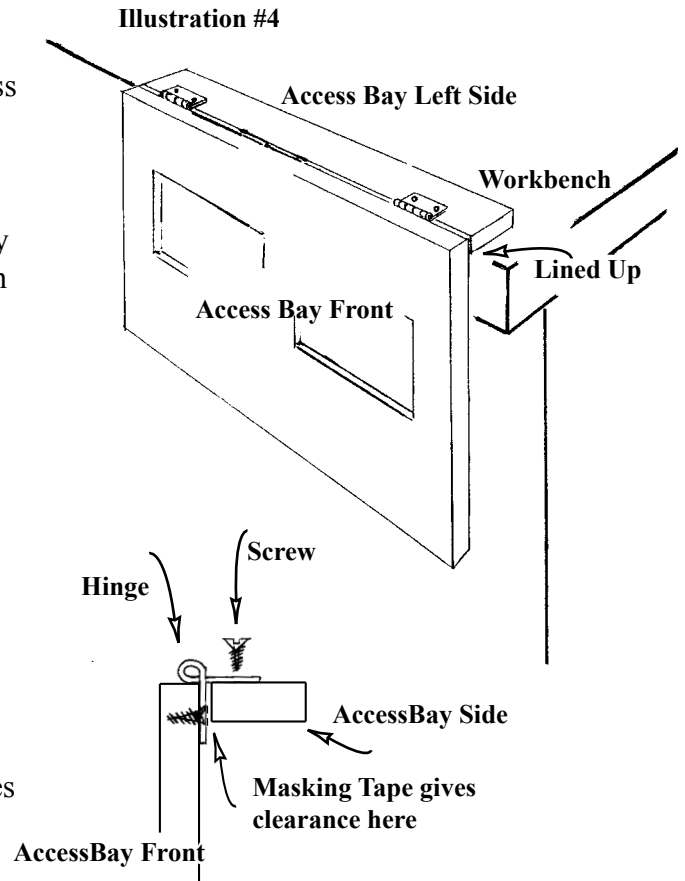

Illustration #5

Glue and Tape the Access Bay Sides to the Housebody's Walls & Access Bay Floors

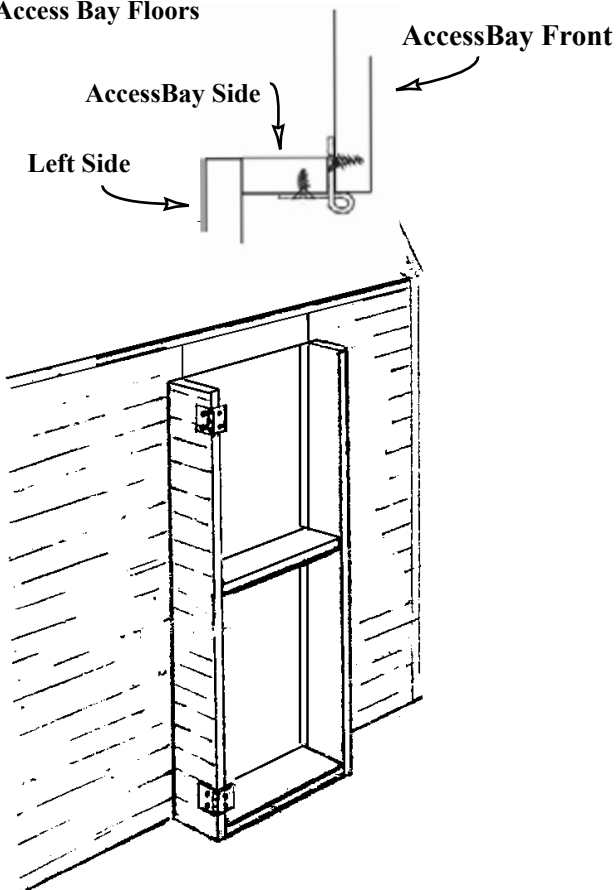
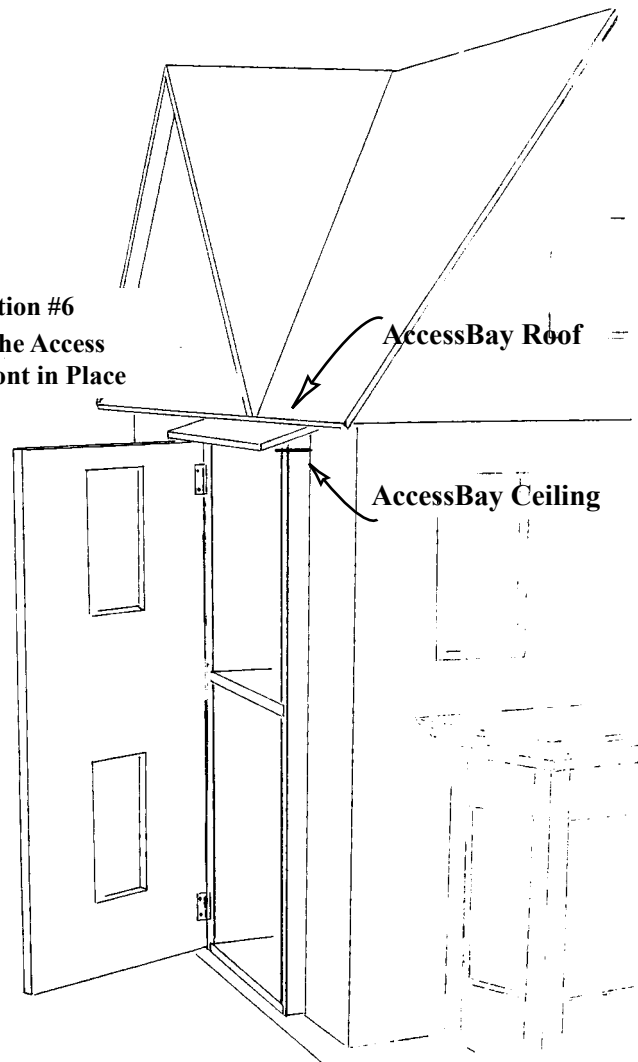

Illustration #6

Hinge the Access Bay Front in Place



V. Window Assembly:

The parts used in this section should be painted ahead of time. If they have not been painted, do so now.

www.realgoodtoys.help has more window assembly photos

- 4) standard windows,
- 1) standard double window,
- 1) narrow double window,
- 2) narrow windows, and
- 2) short windows,

1. **Standard Windows:** Test assemble (*no glue*) the window set.

Practice holding the frame pieces face-down on the work surface and putting on the rubber band. When you can do it every time without pieces flying, then you are ready for glue (Illustration #1).

2. Glue and rubber band together the window frame with the Window Plexi in place. Make sure the assembly is square as the glue dries (Illustration #2).

Illustration #1

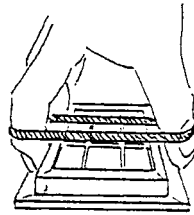

These hands are holding the frame parts down against the table (not squeezing them together)

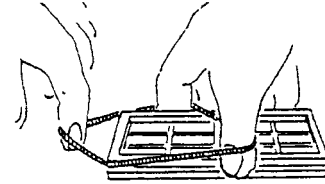

A snip of tape in the corners helps keep the parts still while you put on the rubber band, but take off the tape while the glue dries.

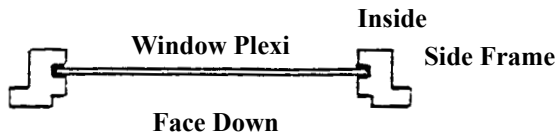
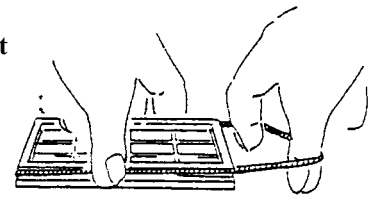

Illustration #2

3. **Short and the Narrow Windows:** assemble these windows as you did the Standard Window.

4. **Standard Double Window:** Lay out and assemble the Double Window face down on the work surface (Illustration #4).

5. Turn the Double Window face up and push the Middle Frame down to the work surface. Adjust the spacing of the Middle Frame with the 1¹⁵/₁₆" Spacers (Illustration #5).

6. Glue the Trim to the Frames centered on the Middle Frame.

7. **Narrow Double Window:** Assemble the Narrow Double Window as you did the Standard Double Window using the 1³/₁₆" Spacers to locate the Middle Frame.

8. Touch-up the sanding and paint, but *stay away from the Window Pane!*

9. Check the fit of the windows in the openings. Make sure the windows can sit level with the house. Trim the corners of the openings square if necessary for a good fit.

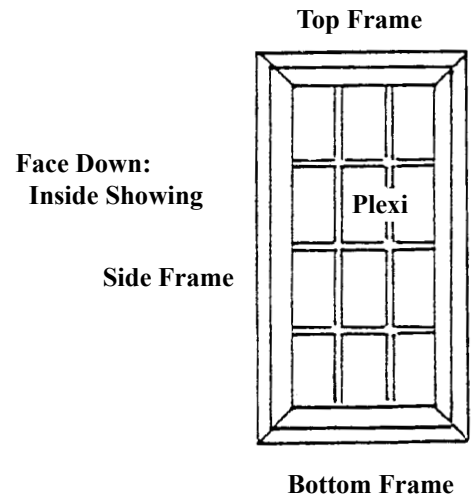

Illustration #3

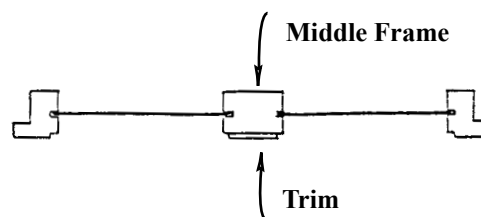
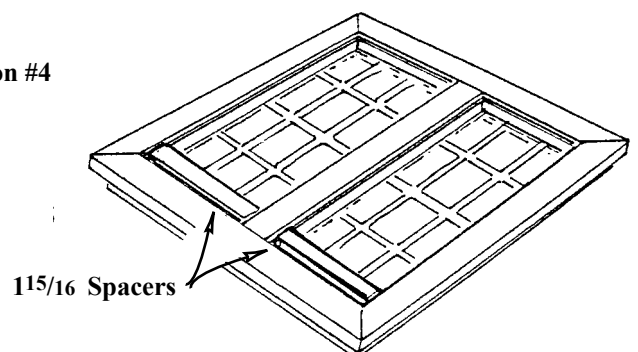
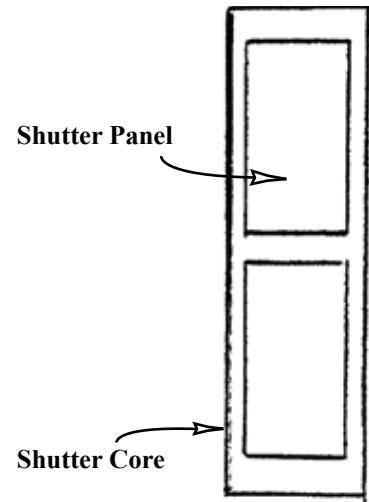

Illustration #4



10. Paint the Shutter parts. Without glue, adjust the spacing of the Shutter Panels on the Shutter Cores. Remove the Shutter Panel, put a scant line of glue on each edge of the back surface, then replace the Shutter Panel. Too much glue will make the panel curl.



VI. Install the windows and door

The parts used in this section should be painted ahead of time. If they have not been painted, do so now.

- 1. Touch-up the sanding and paint. Check the fit of the door in the opening. Make sure the door can sit level with the house. Trim the corners of the opening square if necessary for a good fit.
- 2. Glue the door in place only after the housebody is painted.
- 3. Install the Windows and Doors.
- 4. Glue the Shutters in place against the Windows, centered up and down (Illustration #1).

Do not install Interior Trim until interior finishing is done.

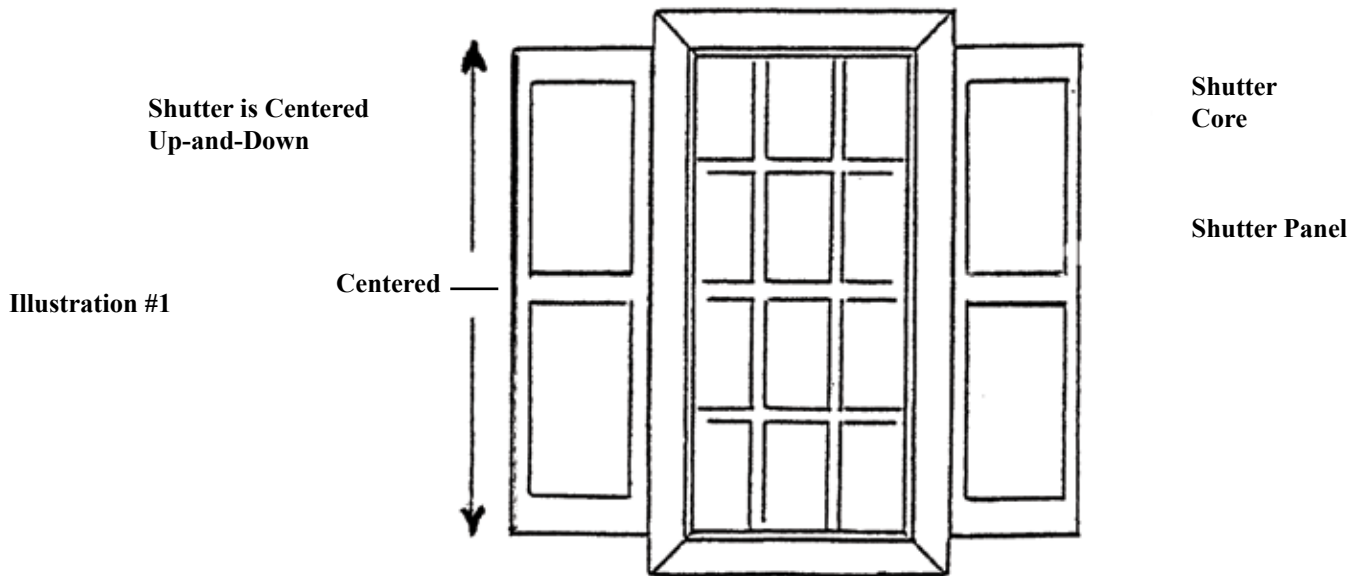

Gable and Attic Endwall Trim:

Cut the Trim material with a fine toothed saw (such as an x-acto™ razor saw or a hack saw). Line up the trim material with the pattern and mark the cuts with a pencil ... there is enough material to get all the parts, but a wrong cut can leave you with two short pieces when you need one long piece. Plan ahead (!), then make your cut. Always cut the longest pieces first, and nest parts that are mitered.

The Attic Partition has all the angles that are needed for the trim. Hold the trim against the side of the Attic Partition to help stabilize the saw when you start a cut, but do not damage the Attic Partition.

Measurements given in this set of illustrations are taken from a model that we built, but may be different from what works on your house. Always test a part in place on the house before the final cut-to-length to make sure your work fits on your house.

1. Cut 1" Trim $12\frac{1}{16}$ ", mitered as shown in Illustration #1 & #6. Without glue, test the Trim along with a False Eave. When the Trim length is right, the False Eave just reaches from roof to roof.

Paint and install the Trim and False Eaves.

2. Trim for the Attic Endwalls: Cut 1" Trim $5\frac{7}{32}$ " mitered like the perimeter of Illustration #2.

For the Gable (Illus. #3 & #4), install the window, and trim around it with $\frac{1}{8}$ " x $\frac{1}{2}$ " Trim (one piece of the $\frac{1}{2}$ " Trim supplied is thicker than all the rest ... just as thick as the lip on the window frame). Paint and install the Horizontal Trim.

Illustration #1

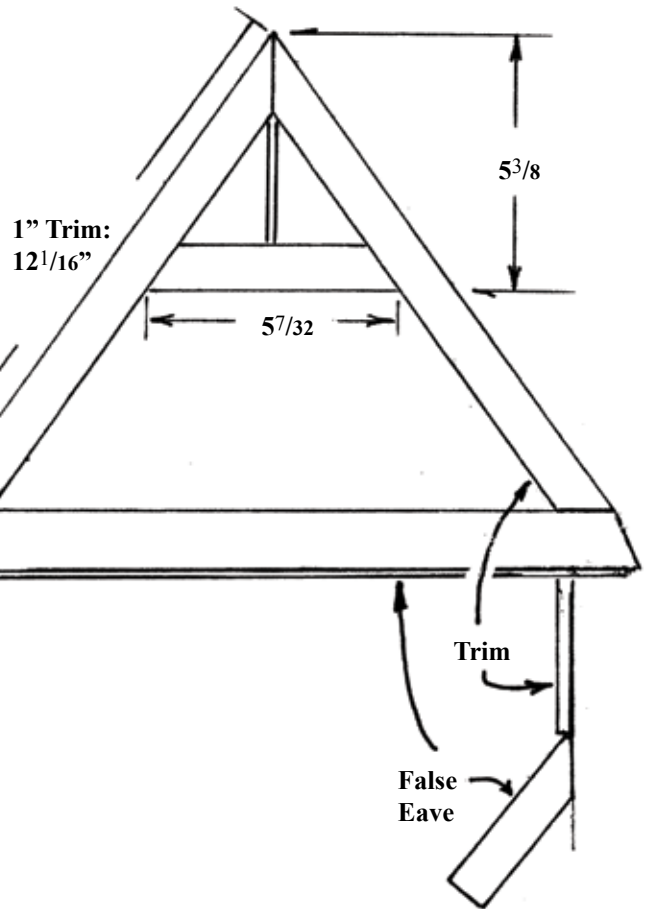

Illustration #2

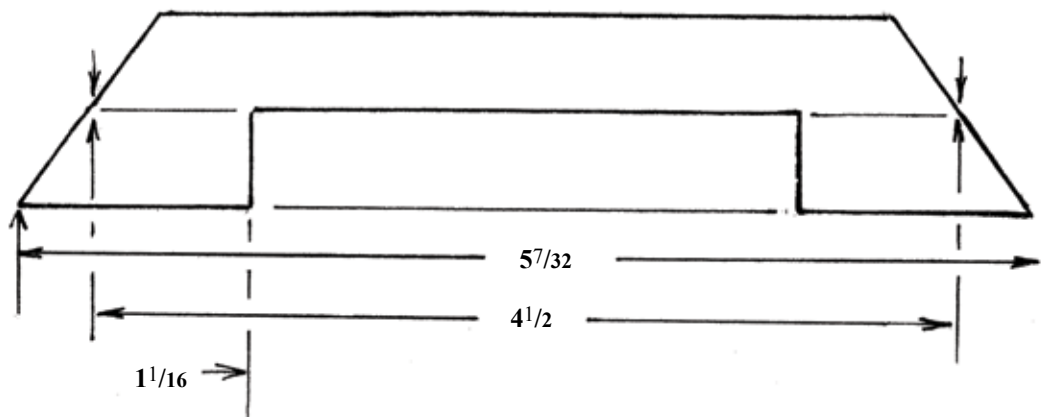

Illustration #4

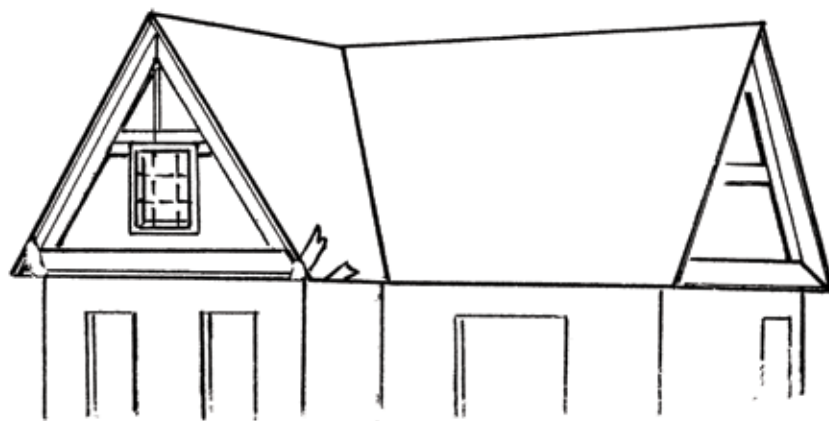
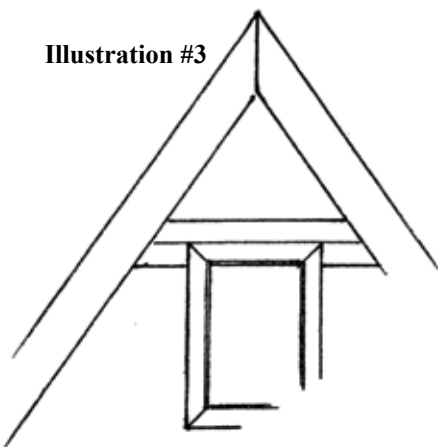

Illustration #3



- 3. Shingle the False Eave (Illustration #5) one full shingle course and one course of shingles cut $\frac{3}{4}$ " long. See the shingling instruction on page 20 and www.realgoodtoys.help.
- 4. Cut, Paint, and install $\frac{3}{4}$ " Trim on the Eaves and $\frac{3}{32}$ " x $\frac{1}{2}$ " Trim (the same thickness as the $\frac{3}{4}$ " Trim) for the horizontals Illus. #6. The bottom edge of the Eave Trim touches the shingles on the False Eave (Illus. #7).
- 5. Cut, paint, and install the $\frac{3}{16}$ " Trim as shown.
- 6. Finish any touch-up painting that is needed.

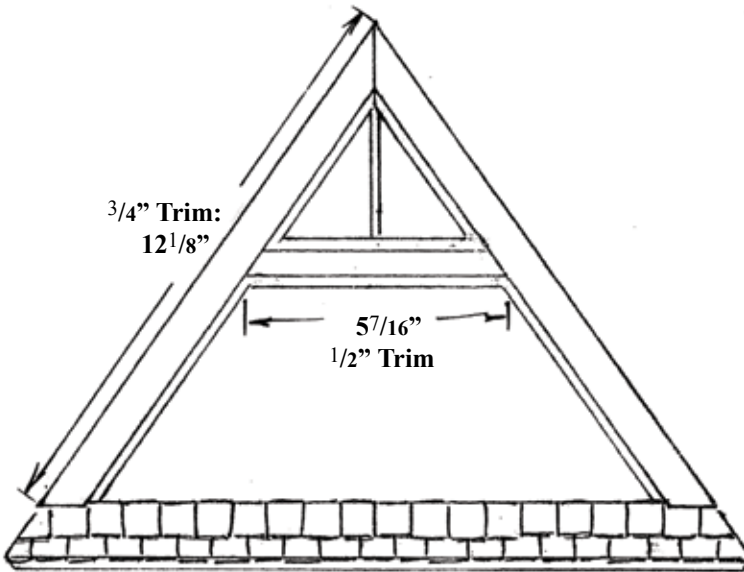
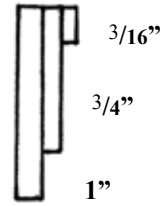

Illustration #6

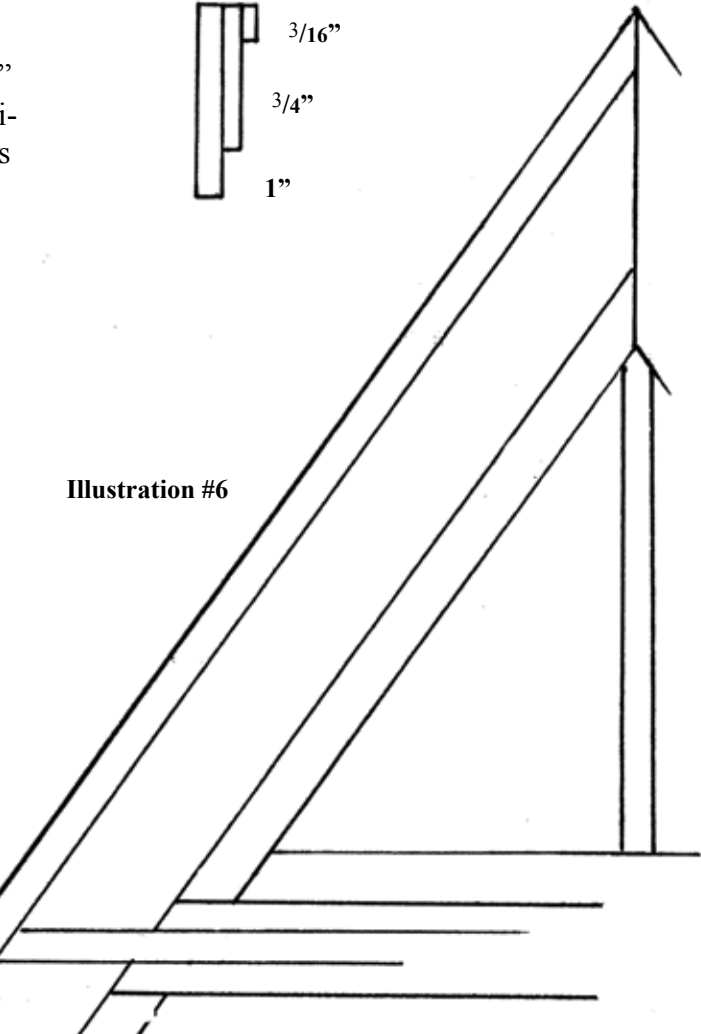

Illustration #7

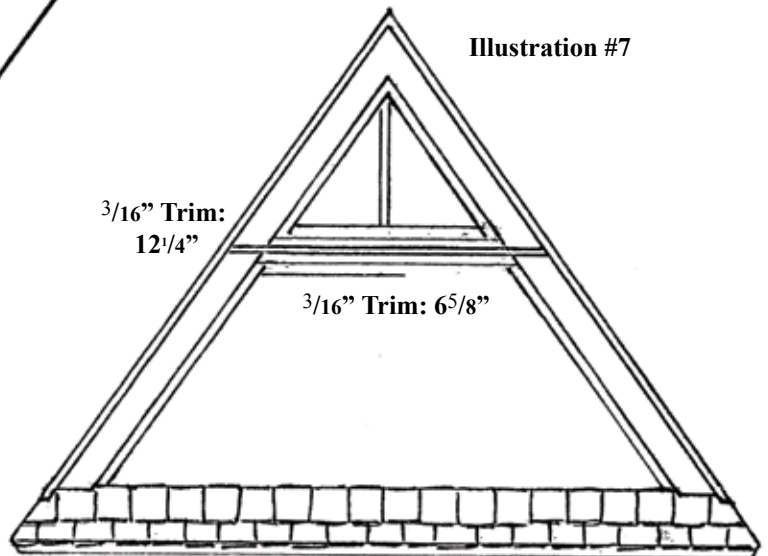
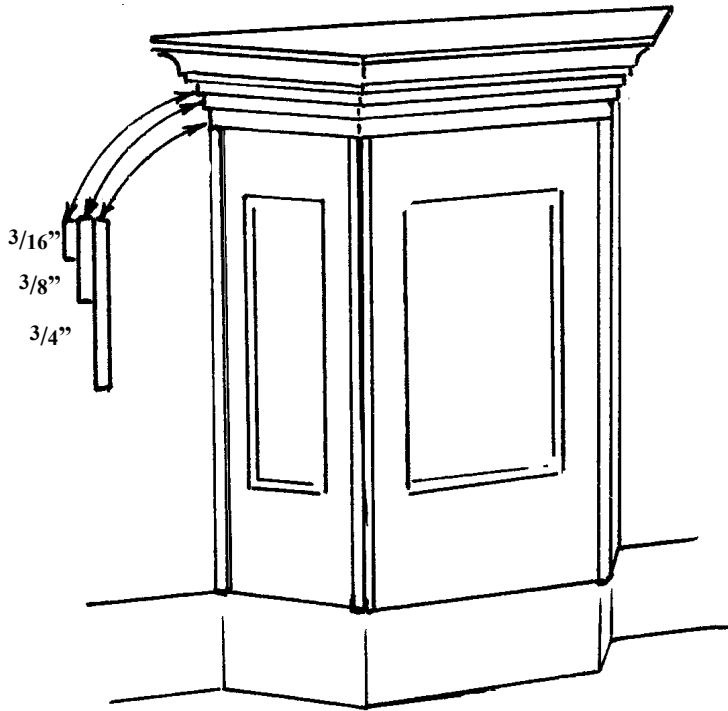

Illustration #8



7. Cut, paint, and install the Front Bay Facia (Illustration #8).

8. Cut, paint, and install the Wall Trim as shown in Illustration #9.

A Trim Cutting photo gallery is at www.realgoodtoys.help

Use this Bevel Guide when Cutting the Ends of the Bay Facia

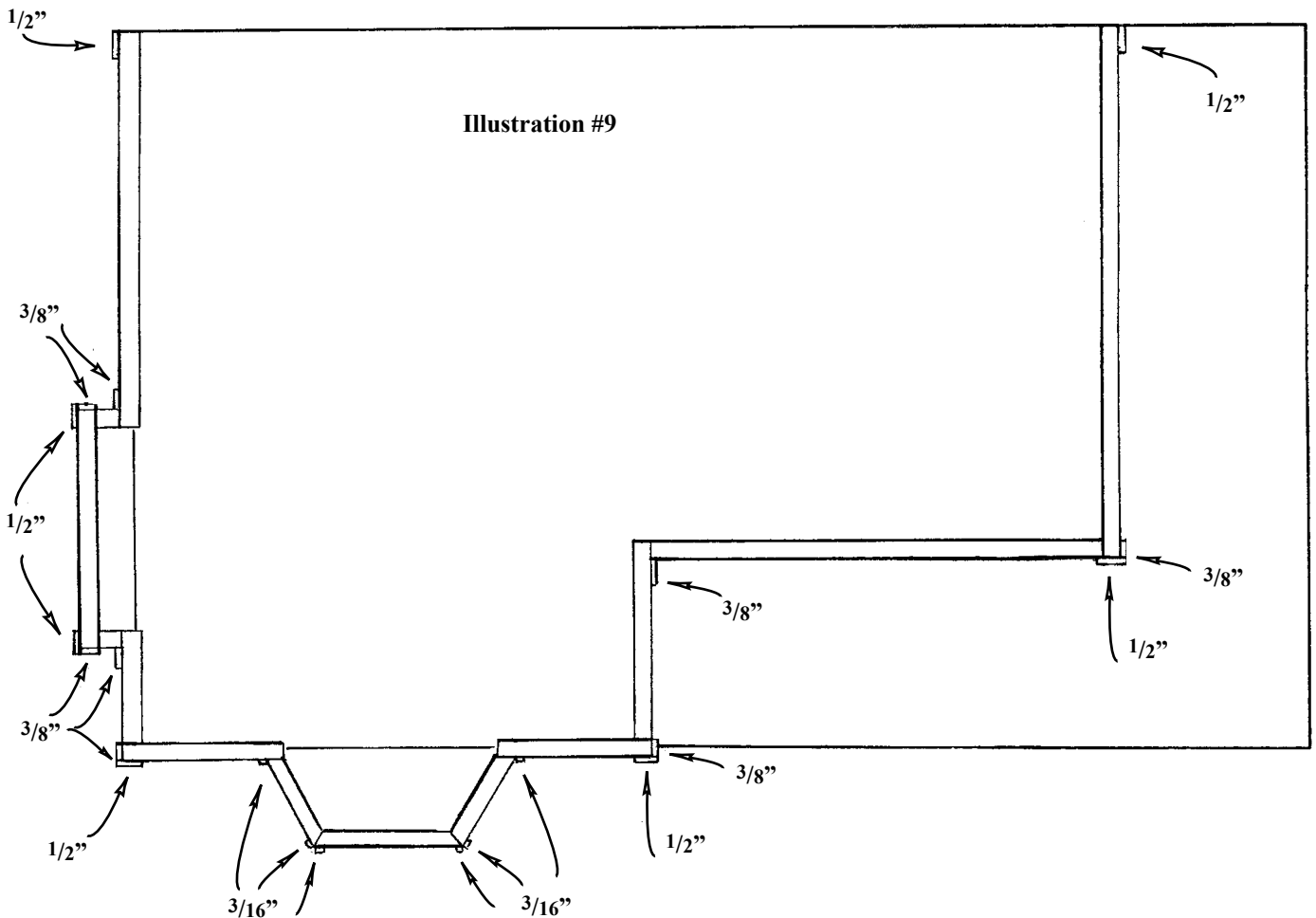

VIII. Finish the Exterior:

1. Attach the (painted) Chimney to the roof in line with the Attic Endwall and slightly lower than the peak.

There are Shingling slideshows at: www.realgoodtoys.help

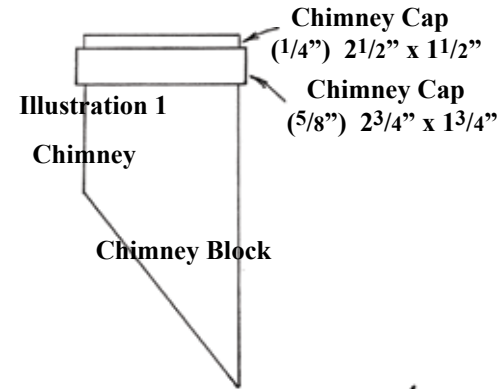

2. **Shingle the Roof:** Glue: Use a thick, solvent-based panel adhesive available in caulking gun tubes at building supply stores. Look for the “Flammable” warning to know it is a Solvent Based adhesive, and follow the manufacturer’s warnings. If there are no warnings or if it says “water clean up”, then it is an acrylic based adhesive and will curl the shingles.

Shingle Illustration #2

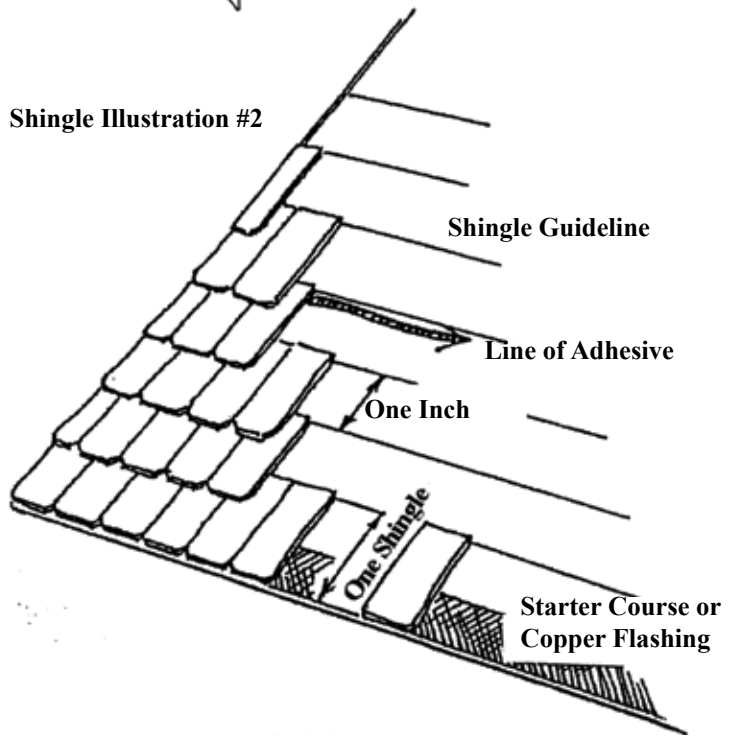

A. Glue a “starter row” or 3/8” long Shingles square edge down along the bottom edge of the Roof, or “Flash” the edge with a 1/2” strip of copper (#SC from *Real Good Toys* is available through your dealer or www.realgoodtoys.com) to prepare the bottom edge of the Roof for the first row of shingles

B. Cut pairs of shingles that, when held in the valley, are straight up-and-down the roof on their outer edges. Shingle the valleys

C. Apply a thin line of adhesive 6” long or so, just below the lowest guideline. Press the top edge of a Shingle into the line of glue, squeezing out the excess. Hold the first Shingle and press another Shingle into the adhesive, tight to the first. Hold the next Shingle and press in another... etc. Repeat all the way across the roof, cutting the last Shingle to fit.

Continue up the roof one row at a time. Start the next row with a half Shingle so that the seam between Shingles is staggered back and forth as you go up the roof. Line up the top edge of each row (except the starters) with the guidelines.

Cut the top row of Shingles so that each row will have the same reveal. Finish the top edge with a “Boston Lap”: pairs of Shingles laid horizontally. Start at the ends of the peak, and, with each pair overlapping the previous pair, work to the middle.

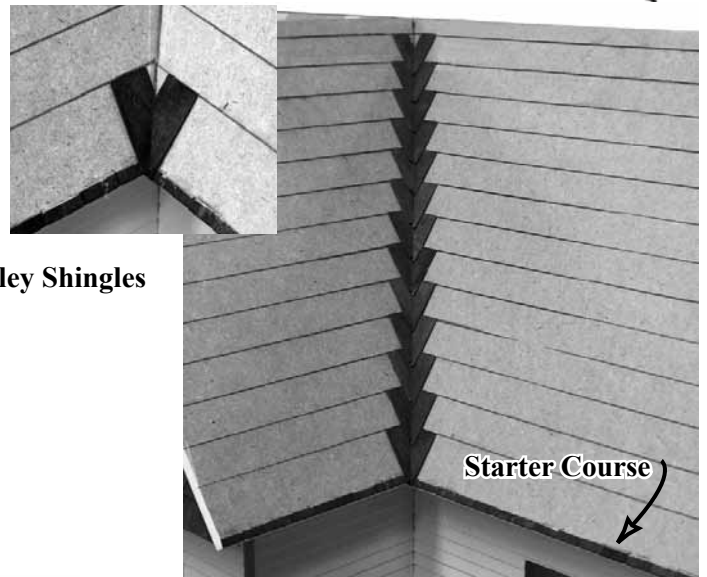

Boston Lap Shown at the Peak

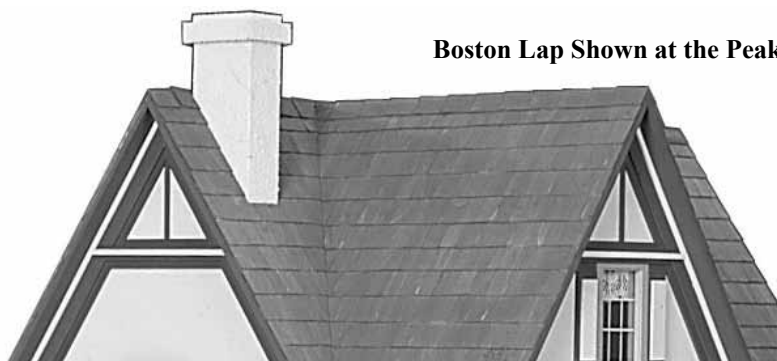

IX. Porch Assembly:

Preview: In this section, you will assemble and install the Porch Posts and Railings.

A Railing Assembly demo is available at
www.realgoodtoys.help

Assemble the Rails

1. Paint (the first coat) and sand the Rails before assembly. Wipe any paint out of the grooves, and do not paint the Rail ends at all.

Paint and sand the Dowels:

a. Dab paint onto a small-celled sponge, less paint is better (a small-celled sponge looks like sponge rubber. Our local dollar store sells small-celled sponges with a scrubby back - cut in half, they are just right).

Put several Dowels on the sponge; rub a second sponge across the top, rolling the Dowels across the paint-sponge.



b. Spread the painted Dowels on waxed paper. Move them around every few minutes as the paint dries

c. Paint all of the Dowels; let the paint dry

d. Lightly rub the dowels around with sandpaper (a small handful at a time) to sand off the raised grain.



Second-coat the paint after the Railings are assembled

2. Assemble the Railings:

a. Match Rails into assembly pairs (the same length).

b. Set the first Rail of each assembly pair on the drawing, lined up on each end. Put a dab of glue and a Dowel in the Rail's groove for each Dowel in the drawing. Adjust the Dowels to match the drawing; be sure all the Dowels are even, straight, and square. Let the glue dry for a few minutes.

c. Lift the Dowels with a piece of stripwood; dab a little glue onto each Dowel's end. Hold the second Rail of the assembly pair over the Dowel's ends at an angle. Push down and scoop the Dowels' ends into the groove.

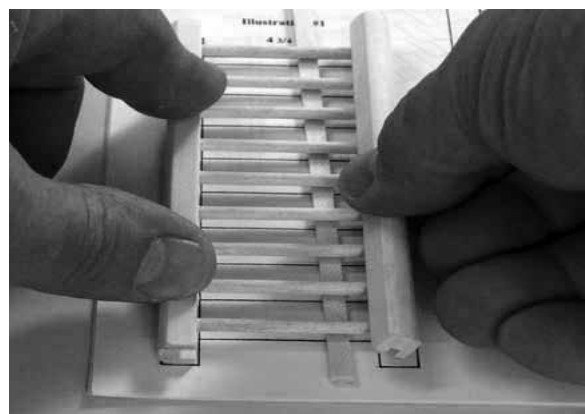

Squeeze the Rails together so the Dowels are fully in the grooves. Hold the Railing set on the drawing; make the Rail ends exactly line up. Final adjust the Dowels - - straight and square. Tape together Dividers to form a square inside corner, and lay the Railings in the corner as the glue dries

d. Repeat for the other Railings

3. Paint (second-coat) the Railings

Note: Variations in printers and "Print Scaling" in your printer dialogue box effect the size of these graphics. If your rails don't match up exactly, center them on the diagram.

Illustration #3

4 sets $9\frac{5}{32}$

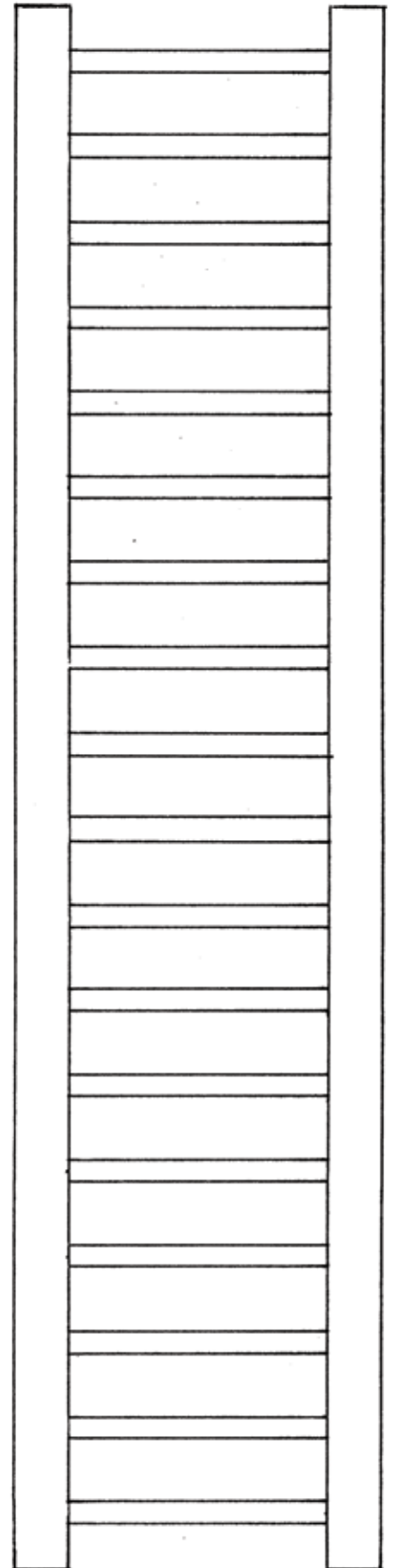

Illustration #2

1 set $6\frac{3}{16}$

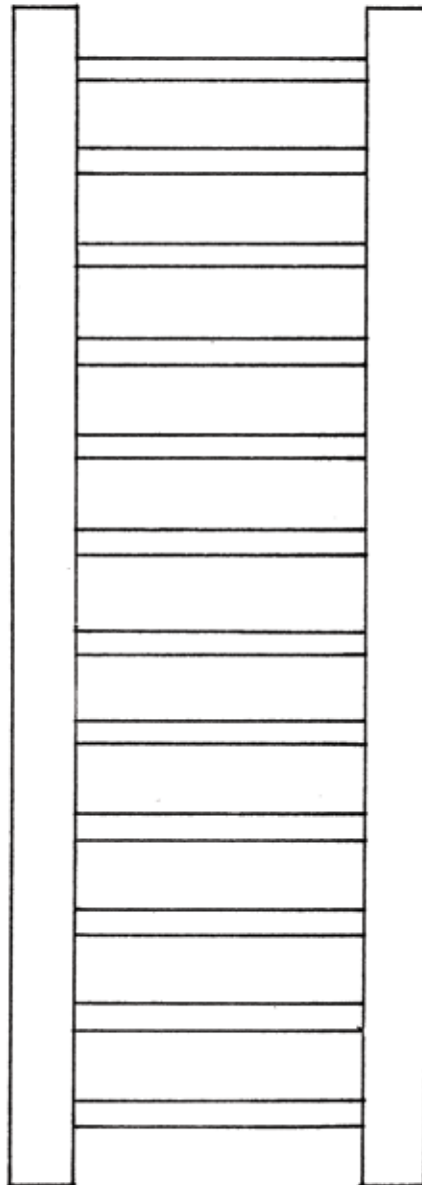
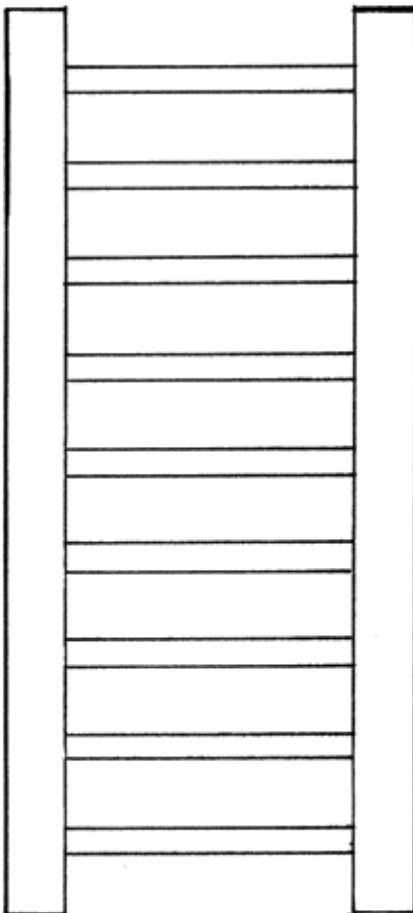

Illustration #1

2 sets $4\frac{3}{4}$



4. Assemble the Flutepost and Beads (Illustration #5).

Wait to install the Railings until the Windows and Doors are in place, and the Shingling is done.

Note: Variations in printers and "Print Scaling" in your printer dialogue box can effect the size of these graphics. If your rails don't match up exactly, center them on the diagram.

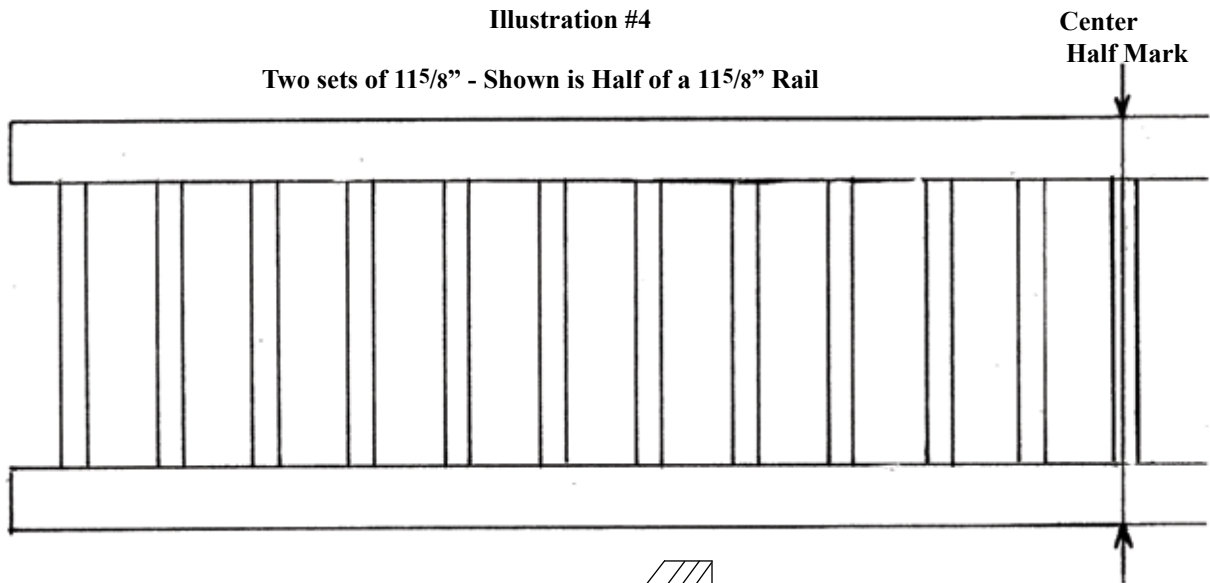

5. Cut Porch Facia sets the same length as the railing sets. Each Facia set uses the following:

- (1) 1" wide
- (1) 3/4" wide
- (1) 3/16" wide

Cut the pieces square on the ends and even in length for each set Illustration #6.

We suggest pre-painting the sets in contrasting colors.

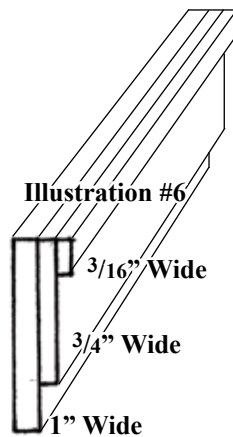
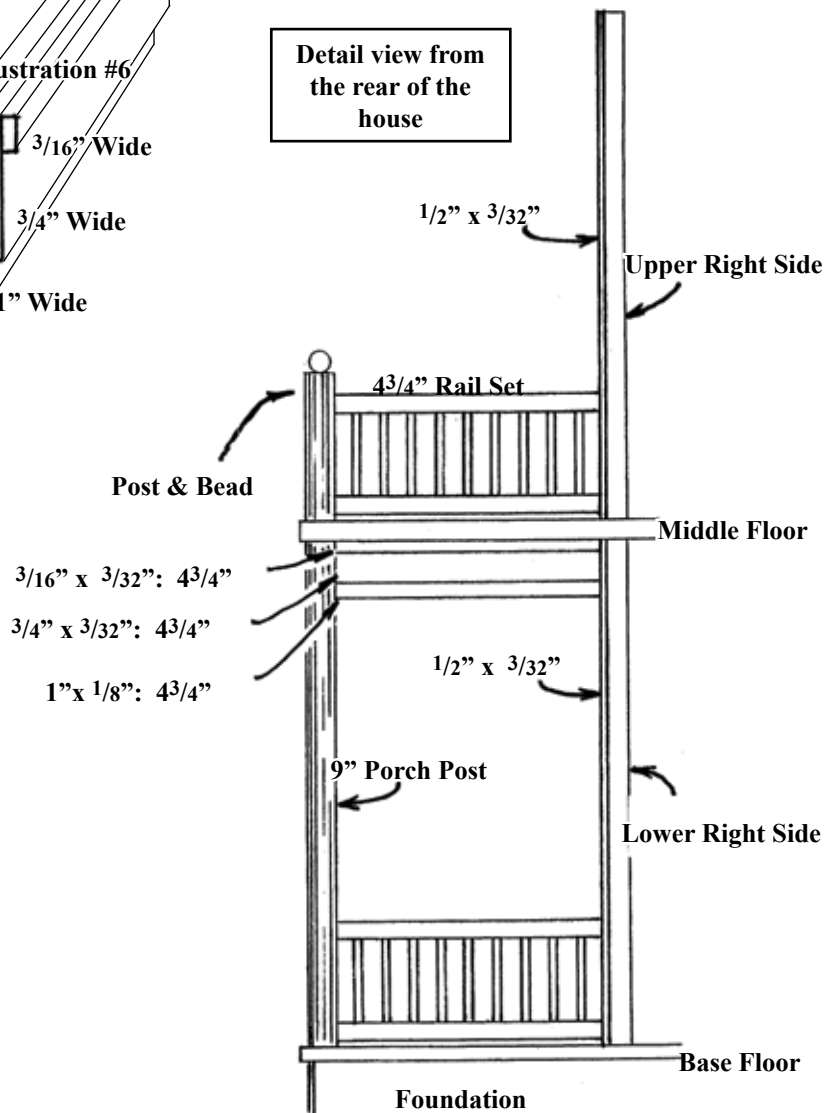
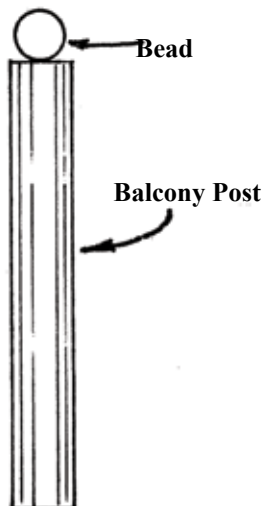

Illustration #5



6. Set up the Rails, Facia, and Posts as shown in Illustration #8. Use a 1/8" Dowel to elevate the Railing sets above the Porch Floor. Set up all the parts without glue, then glue the porch parts in place.

7. Cut 1/2" and 3/8" Trim leftovers for Porch Post Bases:

- (4) 1/2" x 13/4"
- (3) 3/8" x 13/4"

Glue Post Bases centered below the Porch Posts (see photograph).

8. **Flower Box:** Glue the Flower Box centered below the kitchen window (see photograph).

9. **Front Steps:** Assemble and attach the Front Steps following Illustration #9.

Illustration #8

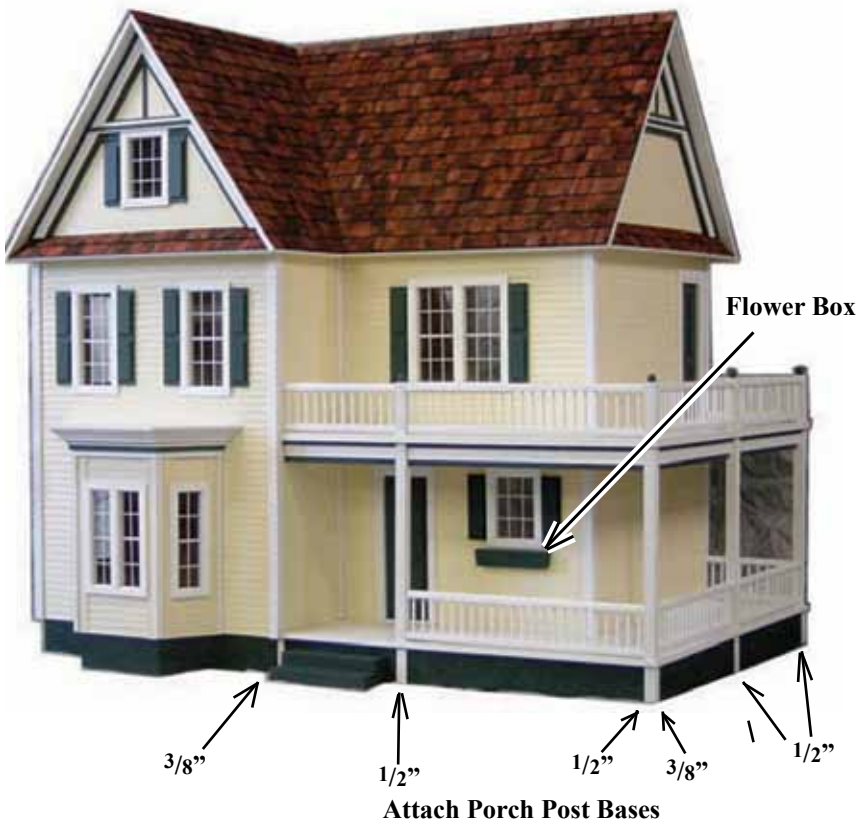
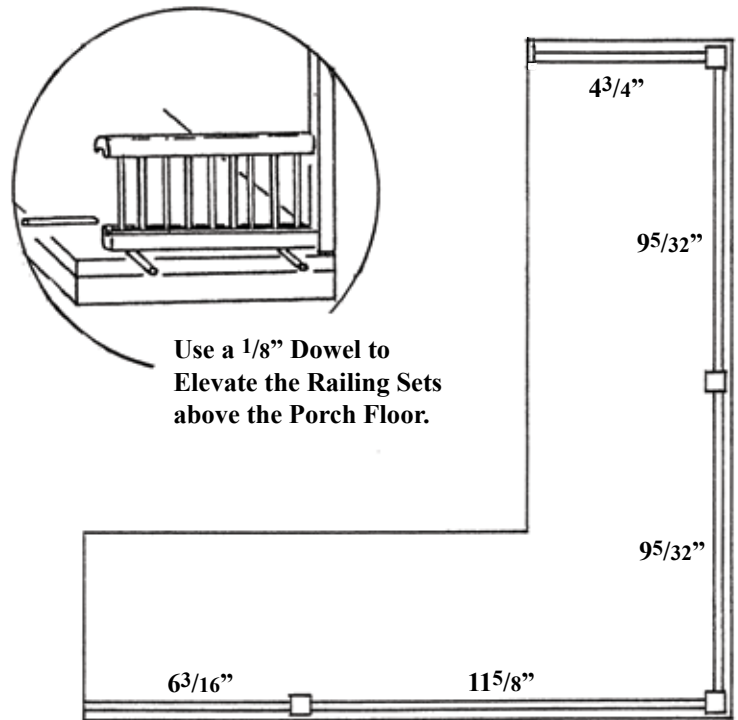
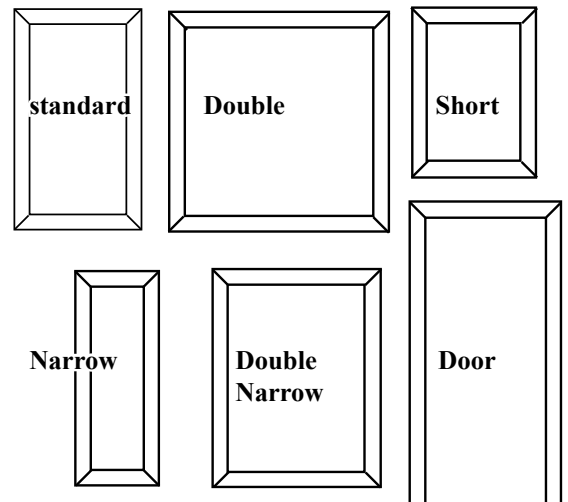
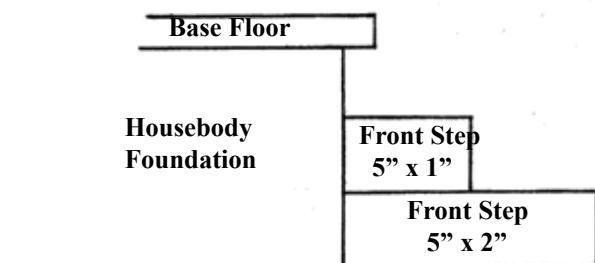

Illustration #9



Interior Window and Door Trim (see the order of interior finishing on page 25) - Assemble and paint the interior window and door trim sets. Glue them centered on the windows or door.

- 4) Standard windows, each uses:**
 - (2) J0644 Interior Window Trim (3/32 x 3/8) 227/32 angled^
 - (2) J0645 Interior Window Trim (3/32 x 3/8) 511/32 angled^
- 2) Narrow windows, each uses:**
 - (2) J0643 Interior Window Trim (3/32 x 3/8) 2 angled^
 - (2) J0645 Interior Window Trim (3/32 x 3/8) 511/32 angled^
- 2) Short windows, each uses:**
 - (2) J0644 Interior Window Trim (3/32 x 3/8) 227/32 angled^
 - (2) J0642 Interior Window Trim (3/32 x 3/8) 323/32 angled^
- 1) Double Standard window uses:**
 - (4) J0645 Interior Window Trim (3/32 x 3/8) 511/32 angled^
- 1) Double Narrow windows uses:**
 - (2) J0642 Interior Window Trim (3/32 x 3/8) 323/32 angled^
 - (2) J0645 Interior Window Trim (3/32 x 3/8) 511/32 angled^
- 2) doors, each uses:**
 - (1) J0640 Interior Door Trim (3/32 x 3/8) 311/32 angled^
 - (2) J0641 Interior Door Trim (3/32 x 3/8) 711/16 angled^

Finish the Inside...Plan Ahead!

Interior finishing involves so many choices! Will this house be a play-house or a display for miniatures? What accessories will be used and where will they go? Wiring? Wallpaper? Tile or carpeting? Every choice makes a difference in the order of finishing. Real Good Toys has provided materials for some basic interior work, but you may choose to do it differently.

- Make your choices
- Get your materials
- Test your layout

With the pieces in your hands, imagine the steps to get to where you want to be. Now you're ready for **your** order of interior finishing. Here's the order that our assembly pro follows for tackling most custom interior finishing:

- Dividers
- Electrical wiring (using "tape" style wiring)
- Ceilings
- Floors
- Wallpaper
- Interior Window and Door Trim
- Stairs
- Baseboard and crown moldings

See www.realgoodtoys.help

Photos of builder's interiors are available at www.victorias-farmhouse.com

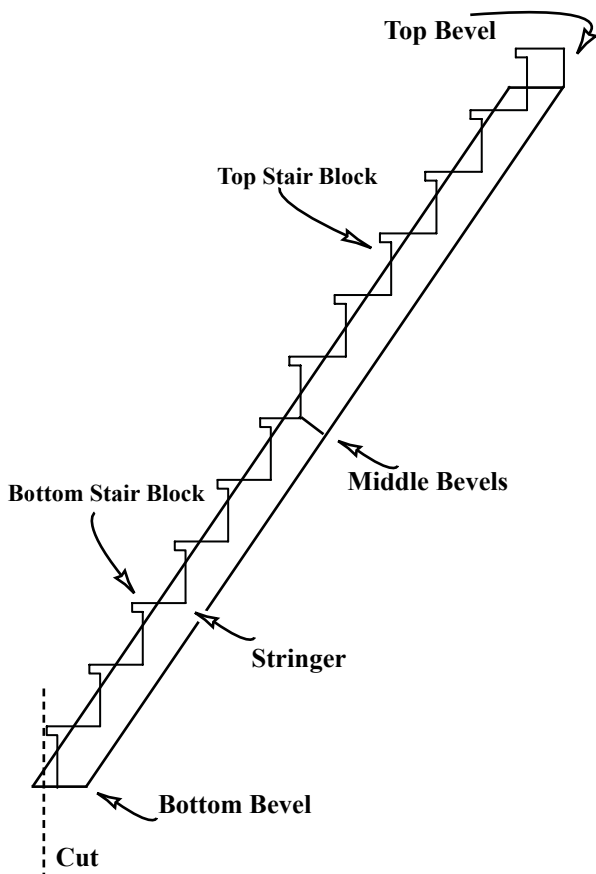
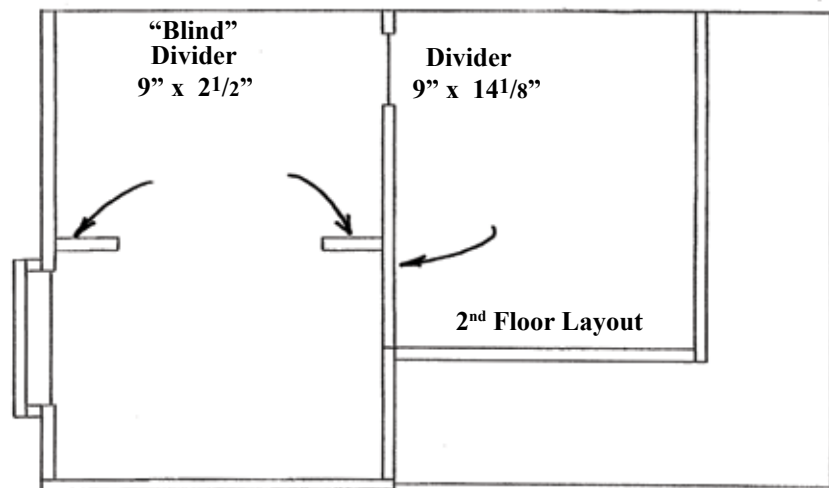
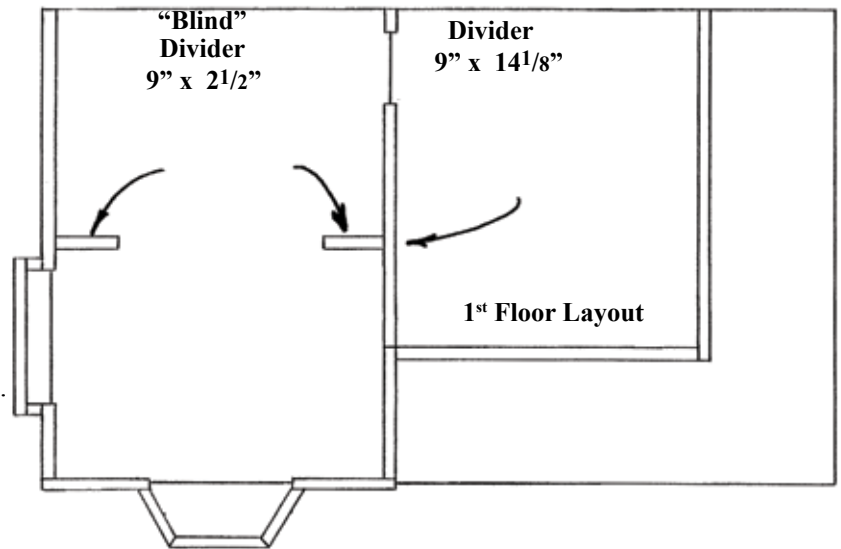

Assemble the Stairs:

1. Glue the Bottom and Top Stair Blocks together. Without glue, test the Stair assembly in the stair hole. The stairs are tight to the wall and the top tread is flush with the floor.

Wait to permanently install the stairs until flooring and wallpapering are done.

Glue the stair assembly in place. Let dry. Trim the Stringer to extend just past the edge of the bottom stair tread. Glue the Stringer to the side of the Stair assembly for support.

You have finished the Dollhouse Assembly part of your project...

ENJOY THE REST

Here are some Builder's Photos... just for fun!

