

Congratulations on your choice of a Real Good Toys product. Your kit has been precision made with meticulous care by our craftspeople using carefully selected materials. This Dollhouse will last for years, even generations, if heirloom care and attention is given during assembly. Take your time and read the instructions completely. If you have questions, ask the experts at your local Dollhouse store or at info@realgoodtoys.com

Before you begin - You have already opened the box and see all the parts organized in boxes and bundles. For the moment, keep them that way. There are important things to do before you open your glue bottle.

Choose your color scheme. Look at houses in your community, models in your local Dollhouse shop or at our website: realgoodtoys.com; look at plan books from a paint store or architectural books at your library (a favorite is: *Painted Ladies* by Michael Larsen and Elizabeth Pomada). You will be painting some of the parts right away so get the paint now. Choose high-quality semi-gloss latex enamel paints for ease of use and durability.

Prepare your space: This dollhouse will spread out over a large area while it is being built. You will need a large flat tabletop for the house, several boxes to keep parts organized until they are needed, and several trays lined with waxed paper for holding small parts like windows and shutters.

A snap-lid box will keep your tools and supplies handy between building sessions.



Tools and Supplies:

Tape measure or ruler, Pencil, Sticky notes (like Postlts®)

White glue (like Aleene's Tacky Glue®) for all construction

Solvent-based Panel Cement for shingles

Masking tape, Utility knife or coarse file

Fine tooth saw (razor saw (like X-Acto®) or a hacksaw)

Painting Supplies, Sandpaper (especially 320gr)

Waxed paper

Postlts®, Aleene's®, and X-Acto® are registered trademarks of their manufacturers and have no affiliation with Real Good Toys

Measure and identify the parts: The kit is packed in groupings that protect the parts, and that is how the Parts List is organized. As you measure and identify the parts, label them with sticky notes using the names from the parts list, and check them off the parts list so you know you have everything. Taking the time now to identify and organize the parts also makes them familiar so you will understand what the instructions intend as you read ahead.

- Plan ahead so you know where you are going
- Read ahead so you know how to get there
- Paint ahead so the parts will be ready when you need them

Options: www.realgoodtoys.com or your miniature dealer

6888: the "Best 1" Dollhouse Electrical Kit

Stucco Grit: Paint additive for foundation texture

Dye-1: Brown shingle dye

Dye-3: Grey shingle dye

SC: Copper flashing

1015: 6-panel interior door fits the Divider

J-FK Interior finishing materials: Baseboard and crown moldings & stairway banisters and landing rails.

This kit will accommodate 1" Scale furniture



Identify the parts: Open one bundle at-a-time. Measure each part and find it on the parts list. Label the parts and group them by the 'instruction section letter' at the end of each part's name(#). These groups are how the parts will be used.

The Woodgrain Flooring, Assembled Door, Sawn Shingles, and other extras make this a "Special Edition" Kit. In any correspondence include the words "Special Edition" so we can help you properly.

Parts List:

(sizes are approximate, and are for identification purposes only - Drawings are not to scale)

- (2) E3904 Side Wall^B: (3/8) 18¹/₂ x 11³/₄, Grooved
 - (1) E3615 Divider^L: (3/8) 9 x 11³/₄, Door Cutout
 - (1) E3616 Stringer^L: (1/8 x 3/4) #11³/₄ //
 - (1) E3611 Gable Triangle^D: (3/8) 7⁷/₈ x 10¹/₈, Window, Bev.
 - (1) U-E3612 Left Gable Roof^D: (3/8) 10¹/₂ x 6⁵/₈, Bev., Groove
 - (1) U-E3613 Right Gable Roof^D: (3/8) 10¹/₂ x 6⁵/₈, Bev., Groove
 - (2) E3614 Attic Partition^L: (3/8) 8³/₁₆ x 6¹/₂, Triangle
 - (1) T1023 Gable Plexi^E: 2¹/₂ x 2¹/₂" painted Mullions
 - (2) T1022 Standard Plexi^E: 5 x 2¹/₂" painted Mullions
 - (1) E3915 Stencil^E (page 10)
 - (1) E3914 Bag of Shingles^G (675)
 - (1) E3906 Porch Floor^F: (3/4) 6³/₄ x 3¹/₄
 - (1) E3905 Porch Roof^F: (1/4) 8¹/₄ x 3⁷/₈, Beveled
 - (1) 6042, Assembled Door^E
 - (1) E3617 Bottom Stair Block^L: 2¹/₄.
 - (1) E3618 Top Stair Block^L: 2¹/₄, Bev.
 - (2) E3626 Flower Box^E: (1/2) 3⁴/₄ x 3³/₄, mitered²
 - (2) E3630 Foundation^B: (3/4) 1/2 x 22 Mitered
 - (2) E3907 Side Foundation^B: (3/4) 1/2 x 11⁷/₈ Mitered
 - (2) E3908 Middle Foundation^B: (3/4) 1/2 x 10⁷/₈
 - (2) E3610 Eave^C: (1/4) 13⁸/₈ x 10
 - (6) E3973 Stripwood^H: (7/16 x 3/32 pine) 10¹³/₁₆
 - (2) T0558 Door Interior Vert Trim^L: (3/8 x 1/8 pine) 7¹¹/₁₆ Mitered
 - (2) E3910 Porch Post^F: 8⁵/₁₆ tall, mitered
- Gingerbread** (page 12):
- (2) E4152 Eave Gingerbread - Left
 - (2) E4153 Eave Gingerbread - Right
 - (1) E4154 Gable Gingerbread - Left
 - (1) E4155 Gable Gingerbread - Right
 - (8) T1020 Window Vertical Frame^E: 5⁵/₁₆, Mitered
 - (4) E3632 Shutter Core^E: (1 x 1/8) 4⁵/₈
 - (16) T1021 Window Horiz. & Gable Frame^E: 2¹³/₁₆, Mitered
 - (4) E3911 Shutter Panel^E: (3/4 x 3/32) 4
 - (2) E3633 Short Shutter Panel^E: (3/4 x 3/32) 17/8
 - (2) E3913 Short Shutter Core^E: (1 x 1/8) 2¹/₈
 - (1) E3909 Door Base^E: (7/32 x 5/32) 3¹/₂
 - (1) E3623 Groove Fill^B: (3/8 x 1/8) 3³¹/₃₂
 - (1) E0686 1/8" Dowels^F, 1/2
 - (1) T0559 Door Interior Horiz Trim^L: (3/8 x 1/8 pine) 3³/₈ Mitered
 - (1) U-E3601 Base Floor^B: (1/4) 22 x 11⁷/₈
 - (1) U-E3602 Mid Floor^B: (3/8) 22 x 11⁷/₈, Stair hole
 - (1) E3903 Front Wall^B: (3/8) 9³/₄ x 22¹/₂, Windows/Door, Grooved
 - (1) E3591 Roof Top Gingerbread^G: (1/8 ply) 23⁷/₈
 - (1) E3609 Rear Roof^C: (1/4) 23⁷/₈ x 13⁸/₈, Beveled
 - (1) E3608 Front Roof^C: (1/4) 23⁷/₈ x 11¹/₂, Gable Cutout, Beveled

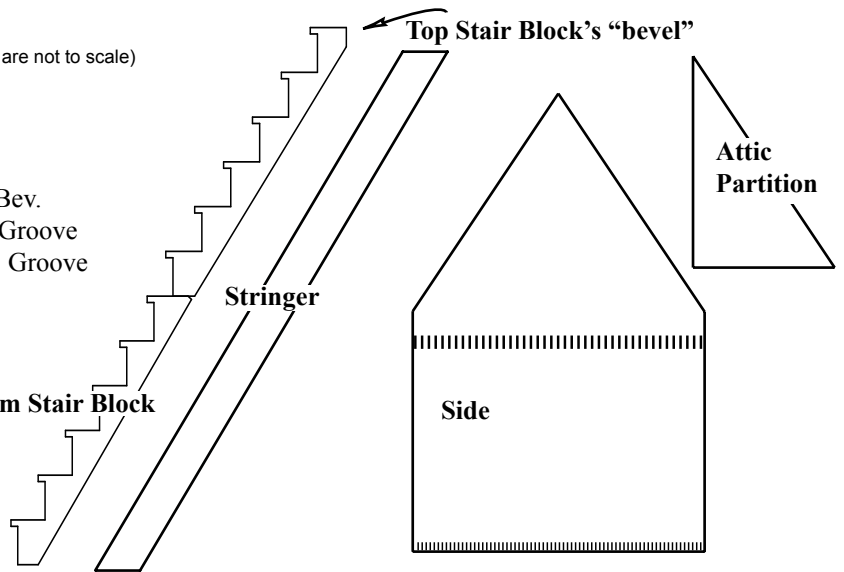

Gable Triangle

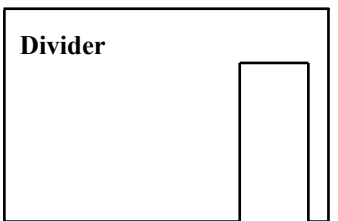
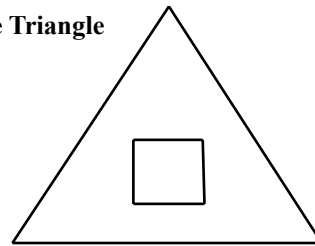

Gable Roofs

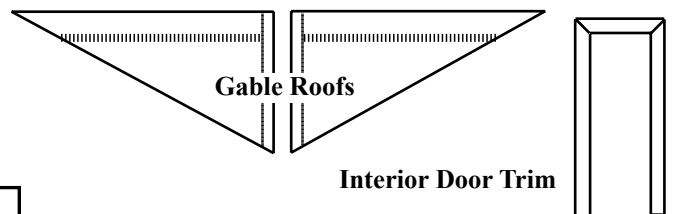

Interior Door Trim

Rear Roof

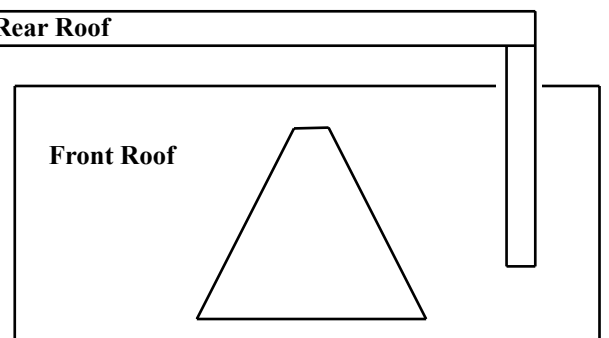

Front Roof

Eave

Mid Floor

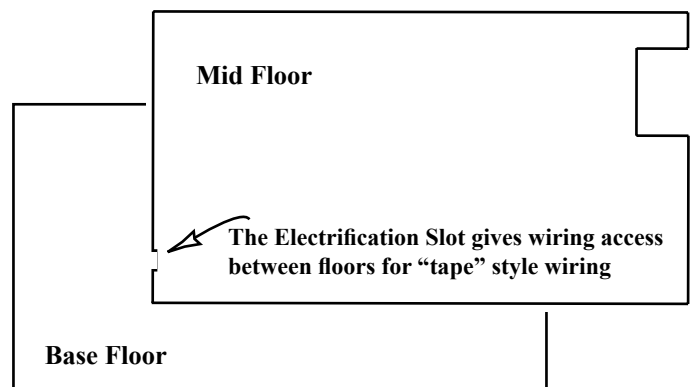

Base Floor

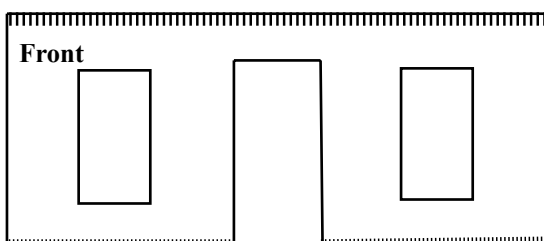

Front

Assembly Notes:

A large, clutter-free, well-lighted work area is helpful during assembly, but a flat work surface is essential.

Read the instructions carefully; look at each of the illustrations. !With the parts in your hands!, think the assembly through before you proceed.

Test fit each time you are ready to glue a piece in place...then you'll know you have it right.

If more tape or a helper is needed, it's good to know that before the parts have glue on them.

Don't be stingy with glue or tape; use generous amounts. Always wipe off excess glue immediately.

Keep one damp rag and one dry rag handy all the time.

Waxed paper keeps small parts or sub-assemblies from sticking to the table as they are being glued or painted. Have weights available for holding things tight as glue joints dry (stacks of books, gallons of pure Vermont Maple Syrup - anything heavy)

Glue the body of your dollhouse together with white, water clean-up glue that dries clear. Do not use instant-bond (super glue), fast-tack, rubber cement, silicone, or hot melt glues. They are all used in some wood applications, but they all have some characteristic that makes them un-desirable for the body of your dollhouse. Carpenter Glue works well, but glue-smear dries yellow or tan; many of the things you glue onto the house are pre-painted – extra glue will show. I use Aleene's Tacky Glue® for all house body assembly. Make sure everything is straight and flat as glue dries... That's the shape that will be permanent.

Glue the shingles on with glue that doesn't have any water in it! If the glue says "water clean-up", it will curl the wooden shingles. Look carefully at the glue you intend to use to be sure it is solvent-based (with warnings about ventilation and flammability), or use hot-melt glue (and watch out for the burns). I use Liquid Nails #LN-601® glue which comes in a caulking-gun tube at the hardware or building supply store (note – Liquid Nails® also makes #990 which is "water clean-up" and will curl the shingles). Check ingredients and warnings!

If you Wallpaper, use Yes® craft paste (for bookbinding or collage) or methylcellulose paste.

Brush paste on the wallpaper, then the wall, and finally smooth the wallpaper into position.

When glue is drying, skip ahead to up-coming assembly steps and prepare the parts that will be used. Before you begin, read the "Finish the Inside" section on the last page.

Questions? Ask the experts at your local Dollhouse store or at info@realgoodtoys.com

A: Getting Started: Do these things before the house assembly

Square the corners of the window, door, and stair holes with a utility knife or double-cut coarse file - each cutout has a rounded corner left over from the tool that made it. Make two cuts in each corner from the outside (one from each direction), then cut from each direction on the inside to cut away the rounding in the corner so the window, door, or stairs will fit.

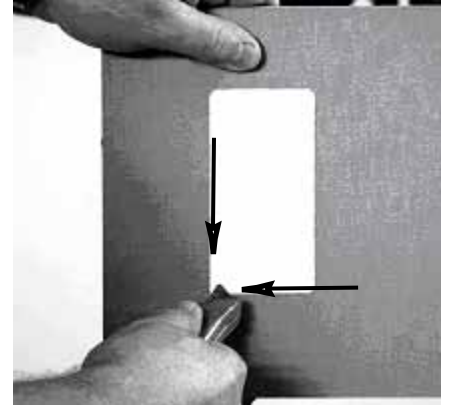

Stain the Shingles: Our pro uses Real Good Toys' Shingle Dye (available through your Real Good Toys miniature dealer) when dyeing the shingles for this house.

Batch dye or stain the shingles several days ahead of time so they will be dry when the time comes to use them (instructions are with the shingle dye or www.realgoodtoys.help).



Paint all the walls; do not paint the edges.

Sand the clapboard **one course at a time**, and re-paint. Use high quality semi-gloss latex enamel, sanding between coats with 320 grit sandpaper. Avoid old gloppy paint and poor quality paint brushes.

Everything gets painted before attaching it to the housebody, but some things (like the window frames) will be assembled before painting. Look for the paintbrush symbol as you preview the instructions. This is where those parts will be painted.

Finish the Floors with clear acrylic urethane like StaysClear® Benjamin Moore to protect them from damage. Wipe off the first coat to leave it thin and un-beaded. When dry, rub the surface with a non-woven abrasive pad (also called "synthetic steel wool") or a crumpled brown paper bag to take off the shine, then put on another coat.

Do not use oil finishes or penetrating stain.

OnLine Support: There are many photos of this house under construction as well as tips, techniques, and extra help with your dollhouse project at: www.realgoodtoys.help

B: Housebody Assembly
Important!

You must be very gentle when you remove masking tape from the printed floors! Slowly, slowly rub the tape off or pull the tape at a flat angle (fingers touching the floor) with the direction of pull in line with the 'floor boards'.

1. Select the Mid Floor. Without glue, test the Floor panel along with the Sides to check the fit (Illustration #2), and to identify the proper position of the stair hole usually closest to the left front corner (Illustrations #4).

2. Spread glue in the grooves of one Side panel (Illustration #3). Use plenty of glue and spread it lightly with your finger to keep it from dripping (if the glue is too runny, wait a bit for it to tack).

Now is a great time for an extra pair of hands.

3. Stand the Mid Floor on end (check the orientation again) and set the Side panel over the Floor in the upper groove.

4. Adjust and check all the parts. The Floor must be flush at the back edge of the Side panels ("flush" means 'forming a continuous, unbroken surface'). The Floor overhangs the front of the Side panels by 1/8" (Illustrations #4).

Glue and tape the walls to the Floors.

5. Very carefully turn the Side/Floor assembly over. Glue and tape the other Side panel to the upper floor.

6. Install the Groove Fill. Tap with a hammer and wood block for a snug fit. Its purpose is to fill the groove along the stair hole leaving a smooth wall (Illustration #5).

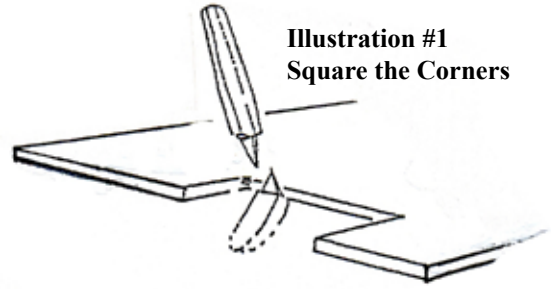

Illustration #1
Square the Corners

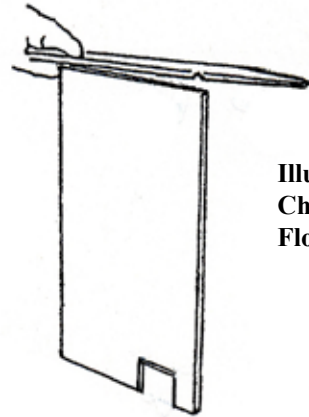

Illustration #2
Check the fit of the Mid Floor and the Side

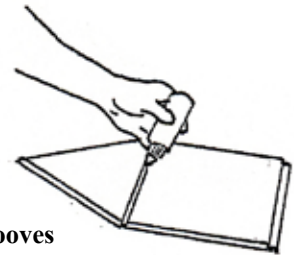

Illustration #3
Spread Glue in the Grooves

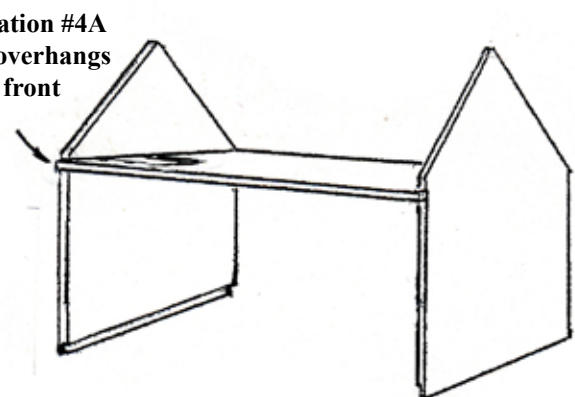

Illustration #4A
Floor overhangs 1/8" in front

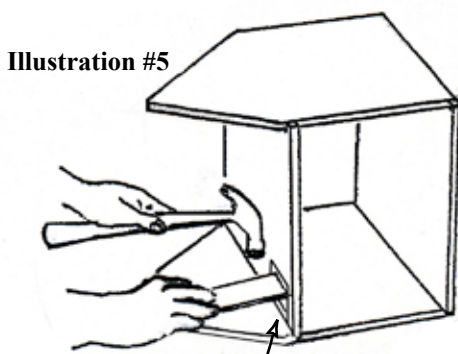

Illustration #5

Groove-fill

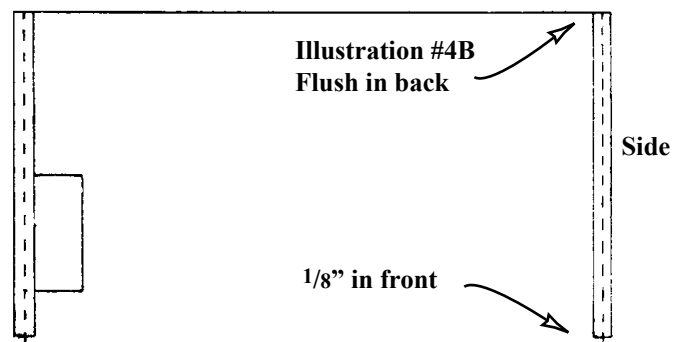

Illustration #4B
Flush in back

1/8" in front

Side

7. Spread the sides slightly to set the Base Floor: glue the Base Floor into the Base Floor Groove. Make extra-sure that the Base Floor is pressed to the top-edge of the groove.

8. Attach the Front to the housebody. Lay the housebody on its BACK on a flat surface.

9. Spread glue in the grooves of the Front panel and on the front edges of the Side panels. Set the Front panel into position on the housebody flush at the sides and bottom edges. Carefully tape in many places along the bottom edge making sure the Base Floor is tight to the top edge of the groove.

Line up one side edge flush all the way from the bottom to the top (This is the operation that straightens the house). Tape the Front securely to the Sides, and nail through the Front into the Floors to hold everything tight as the glue dries (Illustration #6).

Review: Make sure all parts are in place and all the joints are tight.

- Check the position of the stair hole, closer to the Left-front edge.
- The Base Floor is tight to the groove-top.
- The house is straight.

Finish the housebody painting now

Assemble and Attach the Foundation:

Preview: In this section you will assemble the foundation and attach it to the bottom of the Base Floor.

10. Glue and tape together the Foundation at the mitered corners (Illustration #7).

11. Install the Middle Foundations spaced evenly (about 7") from each other (Illustration #8).

Pro Tip: Our Assembly Pro paints the foundation before attaching it to the house.

12. Glue, tape, and weight, the foundation set to the housebody's Base Floor; spaced evenly at the sides and front, flush at the back (Illustration #9).

Illustration #6
Attach the Front

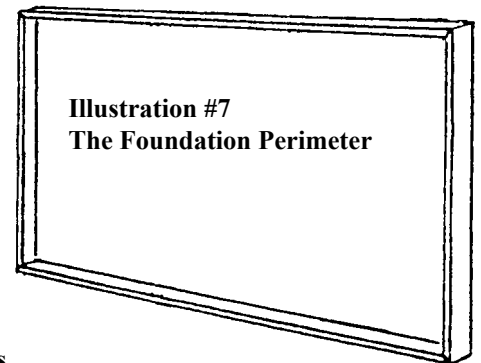
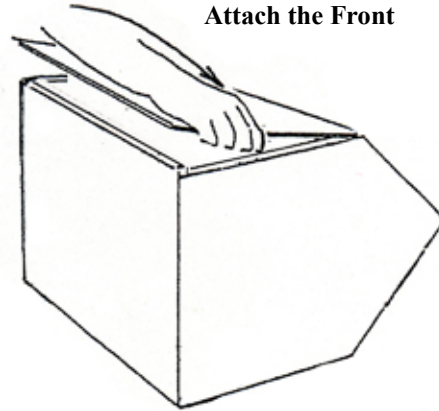

Illustration #7
The Foundation Perimeter

Illustration #8
The Middle Foundations

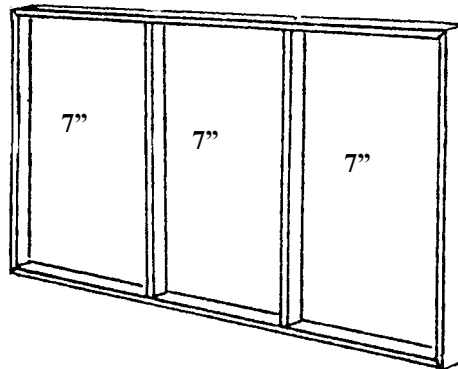
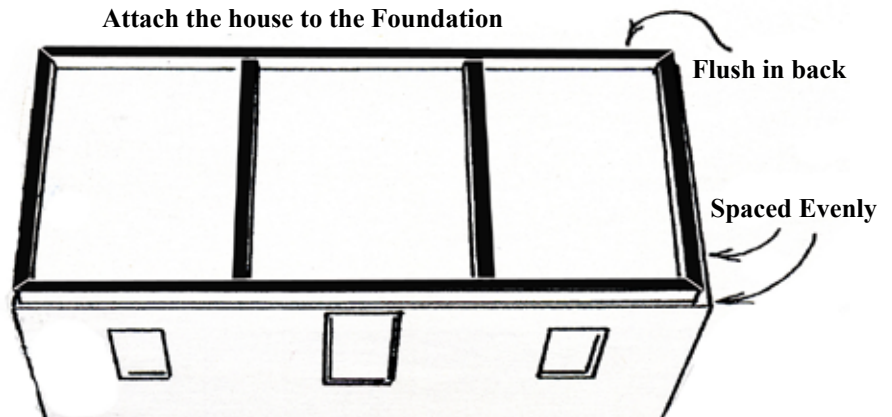

Illustration #9
Attach the house to the Foundation



C: Housebody Roof:

Preview: In this section you will draw Shingle guidelines, and attach the Front and Rear Roofs, and the Eaves.

Tip: now is an easy time to pre-cut wallpaper for the attic

13. Without glue, hold the Front and Rear Roofs on the house to see how the bevels touch at the top. (Illustration #14) The blunt edges at the top form a gluing surface for the Cresting (Roof-Top Gingerbread).

14. On the outside of the Front Roof Panel draw guidelines for locating Shingles. The first guideline should be drawn one Shingle length from the bottom edge. Draw the rest of the guidelines spaced 1" apart. See Illustration #10 and the Guideline Measure (life size spacing) along the edge of this page.

15. Prepare several flaps of tape along the top outside edge on the Front Roof. Lay the Front Roof face down on a flat work surface (Illustration #11).

16. Glue the Rear Roof to the Front Roof, even at the top and flush on both ends (Illustration #12).

Pro tip: trace and paint the underside of the Roofs before attaching them to the house

17. Without glue, test the Roof set in place on the sides of the housebody, make sure the roofs are centered side-to-side (Illustration #13).

Take the Roof set off, then glue and tape the Roof set in place centered side-to-side.

18. Glue and tape the Eaves in place, on the remaining exposed top edge of the sides, flush at the outside edge of the Rear Roof. Look under the Eaves to check that the spacing is even (Illustrations #15).

Illustration #10
Shingle Guidelines

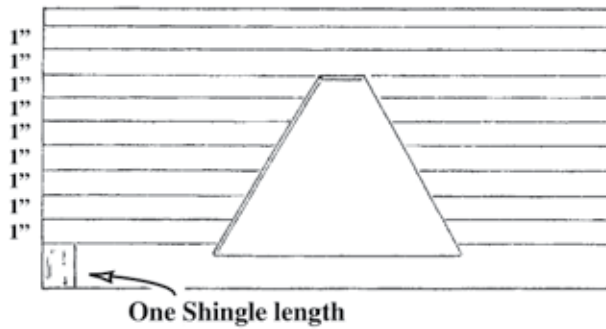

Illustration #11
Front Roof
Face Down

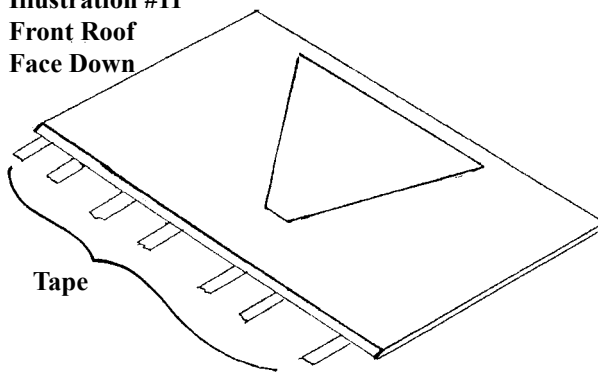

Illustration #12
Rear Roof

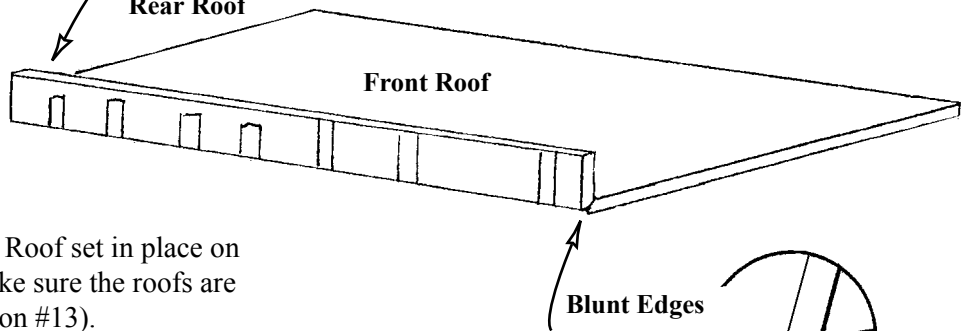
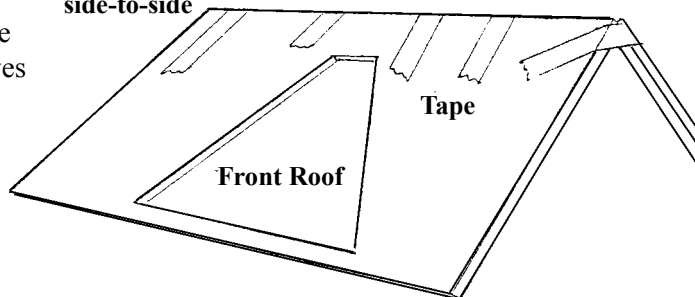

Illustration #13
Roofs centered
side-to-side



Blunt Edges form
a Gluing Surface

14
Front Roof
Rear Roof

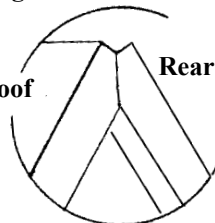
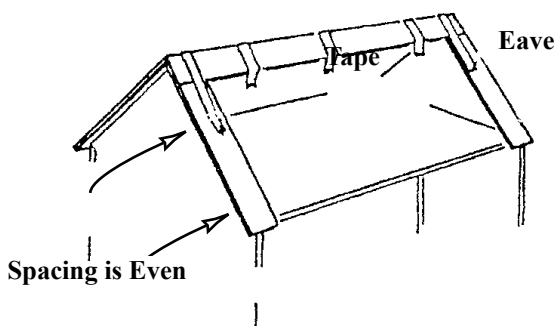

Illustration #15



One Shingle Length

1"

1"

1"

1"

1"

1"

1"

1"

1"

D: The Gable:

Preview: In this section you will draw shingle guidelines (optional), shingle the Gable Triangle; and install the Gable set.

19. Draw Shingle guidelines on the outside of the Gable Triangle. The first guideline should be drawn one Shingle length from the bottom edge. Draw the rest of the guidelines spaced 7/8" apart (Illustration #16).

To create the "Cottage Weave" shown, our pro draws a 2nd line 1/4" below the 7/8" spaced lines, and butts every-other shingle to this lower line

20. Shingle the Gable Triangle (Illustration #17). Follow the Shingling instructions in the "Shingle the Roof" section. Let the glue dry overnight.

Trim the Shingles to match the edges of the Triangle. Cut from the inside laying your x-acto® knife or single edge razor against the edge of the Triangle, and make several light cuts **starting at the bottom and working to the top**. Cut the Shingles again, this time from the outside to leave 1/8" on the edge un-shingled (this fits into the Gable Roofs' grooves). Cut from the bottom to the top - gentle and careful!

You can skip ahead to the section for assembling the Windows and Door (even the Porch section) and come back to here when the Gable Triangle's Shingles are dry.

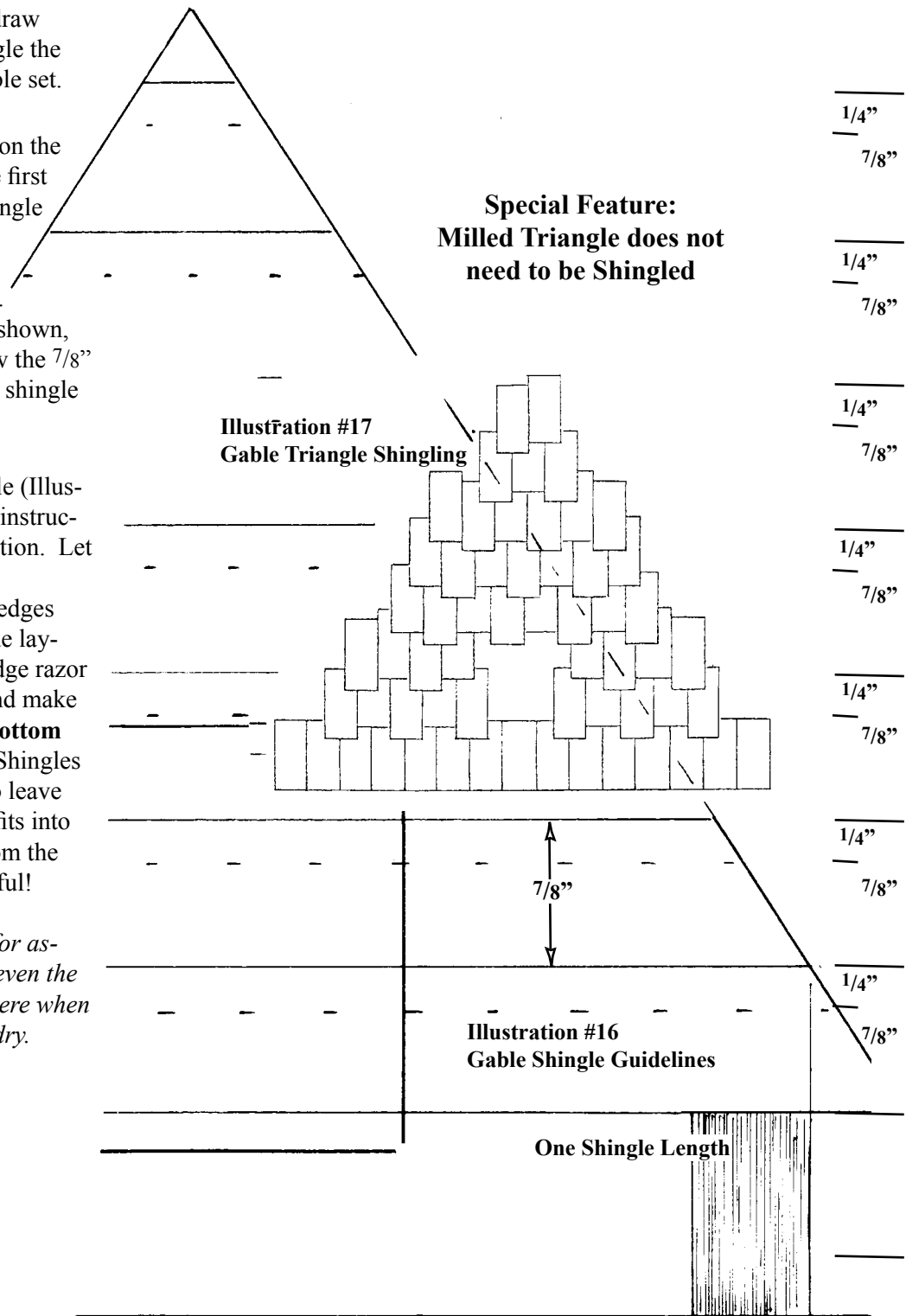

21. Draw Shingle guidelines on the outside of the Left and Right Gable Roof panels. Draw each of the guidelines spaced 1" apart beginning at the bottom edge.

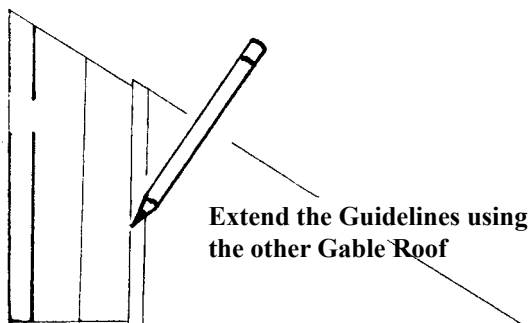
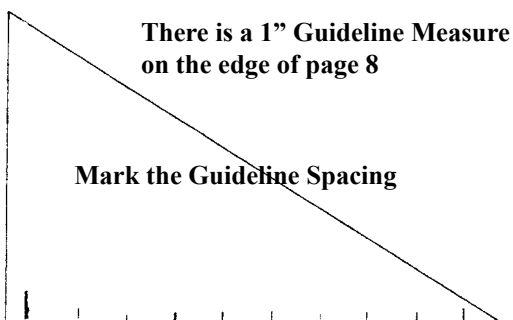

Draw Shingle guidelines on the outside of the Left and Right Gable Roof panels. Draw each of the guidelines spaced 1" apart beginning at the bottom edge.

 22. Paint the underside of the Gable Roofs on the outside of the Grooves

23. **Assemble the Gable Roof Set:**
On a flat work surface, layout the Gable Left and Right Roofs with the bevels face down, and the points touching across the top edge.

Tape the roofs together at the top edge (Illustration #18).

Turn the roof set over and spread glue in the "V" formed by the bevels. Fold the roofs together; tape them on the ends (Illustration #19).

24. **Attach the Gable Triangle:** Glue and tape the Gable Triangle into the grooves of the Gable Roof set (Illustrations #20 & 21). Let the glue dry.

25. Glue and tape the Gable in place on the House Roof. Stretch tape from the inside of the Gable to the inside of the House Roof for a tight fit. Check to be sure the Gable is straight as the glue dries (Illustration #22).

Touch up Paint:

26. Finish painting the housebody.

Illustration #18
Tape the Roofs together at the top edge

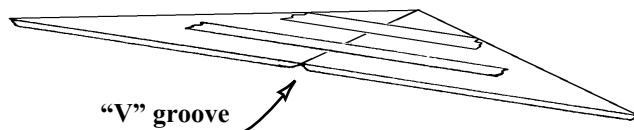

Illustration #19

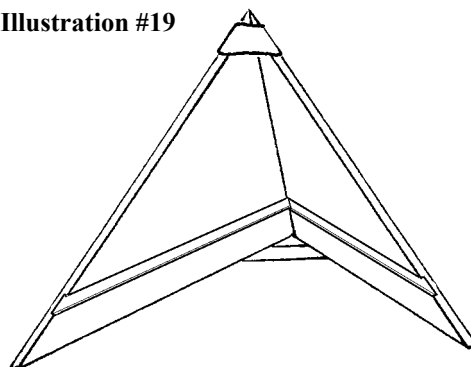

Illustration #20
Edges line up exactly

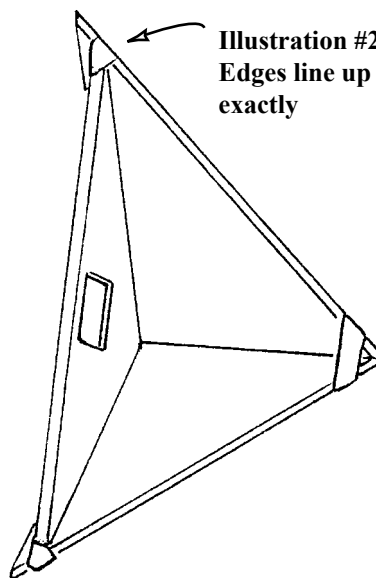

Illustration #21
Use plenty of tape

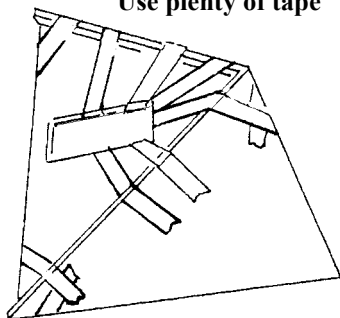
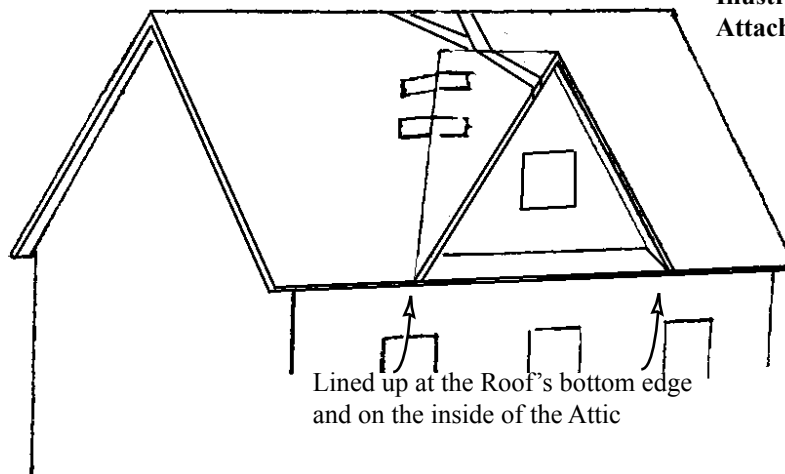

Illustration #22
Attach the Gable



Lined up at the Roof's bottom edge and on the inside of the Attic

E: Window Assembly:

Assemble the window frames before painting

27. Test assemble (**no glue**) a window set Practice holding the frame pieces face-down on the work surface and putting on the rubber band (Illustration #23: a scrap of tape at each corner helps). In the illustrations, the hands are holding the frame parts down, not squeezing them together. When you can get the rubber band on every time without pieces flying, then you are ready for glue

28. Glue and rubber band together four (4) window frames. Make sure the assembly is square as the glue dries (Illustration #24).

Gable Window: Glue and rubber band together two sets (2) of four 2¹³/₁₆" Window Frames.

29. Check the fit of the windows in the openings. Make sure the windows can sit level with the house. Trim the corners of the openings square if necessary for a good fit.

30. Paint the Shutter parts on both faces. Without glue, adjust the spacing of the Shutter Panels on the Shutter Cores (Illustration #25). Remove the Shutter Panel, put a scant line of glue on each edge of the back surface, then replace the Shutter Panel. Too much glue will make the panel curl.

31. The Door: Pull the pin from the bottom of the Door and tip out the door panel for painting (tape the pins to the bottom of the threshold so they won't be lost)

Check the fit of the Door and Door Base in the opening. Trim the corners of the opening square if necessary for a good fit.

Glue the Windows, the Shutters, and the Flower Boxes in place only after everything (including the Housebody) is painted. Wait to install the Door and Door Base until the Porch is complete.

Attach the exterior window frames as part of the exterior finishing. The Panes and Interior frames are installed after the interior finishing is done (wallpaper, paint, etc.): set the window plexi into the window cutout and glue the interior window frame in place.

Illustration #23
The hands are holding the frame parts down, not squeezing them together

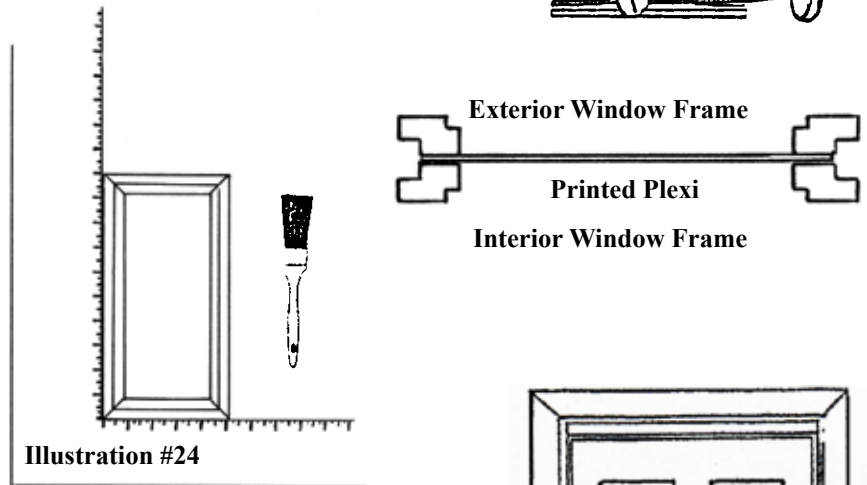
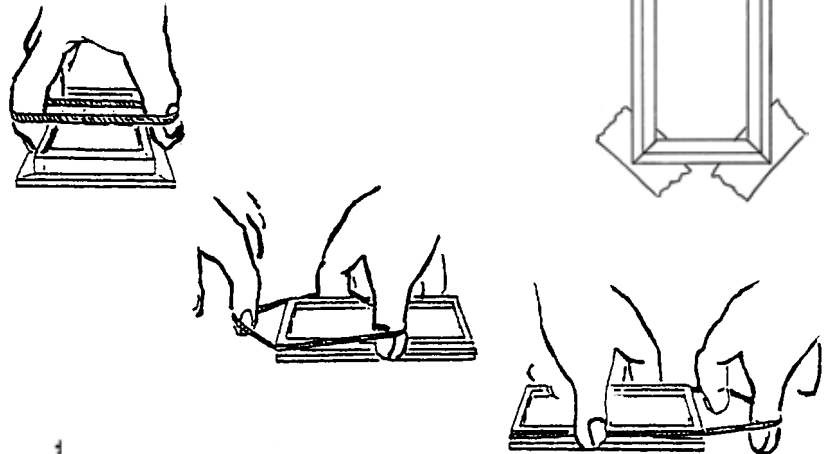

Illustration #24

6042 door with examples of how stenciling can be used

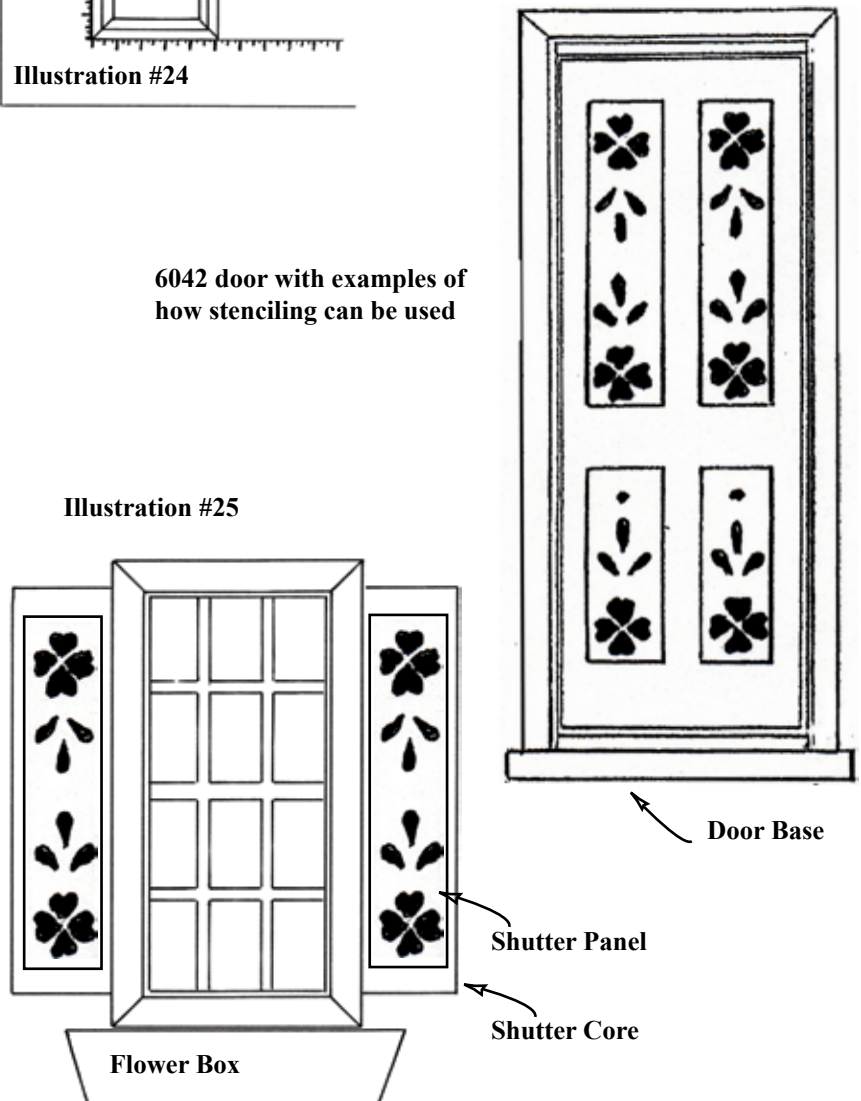

Illustration #25

F: Porch Assembly:

Preview: In this section, you will assemble and install the Porch.

- 32. Glue the Porch Floor to the Foundation centered side-to-side under the Door, and to the Housebody's Front Panel. Let dry.

Now is a good time to draw Shingle guidelines on the Porch Roof.

- 33. Glue a 1/8" Dowel-1/2" long into the drilled hole in each Porch Post, then set and glue the Post dowel into the drilled holes in the Porch Floor. Make sure they are straight as the glue sets. (Illustration #29)

- 34. Glue the Porch Roof to the Porch Posts and the Housebody (Illustration #29)
(This step is easier if you tip the house back).

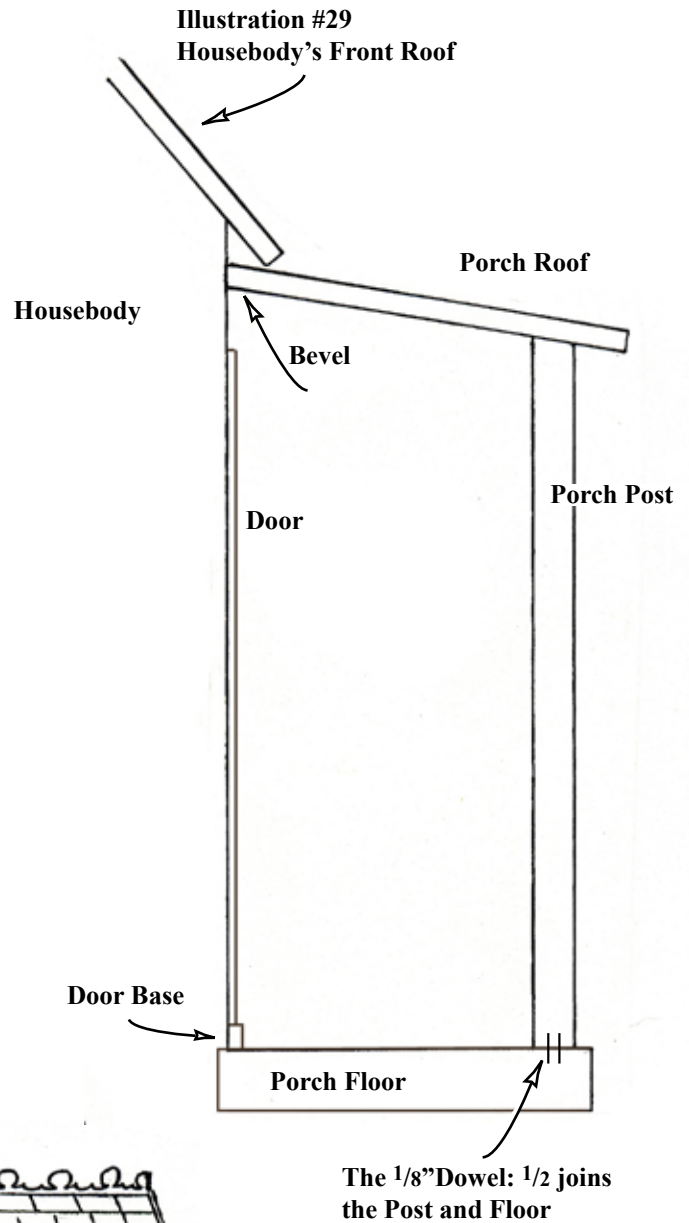

E3591
Roof Top
Gingerbread

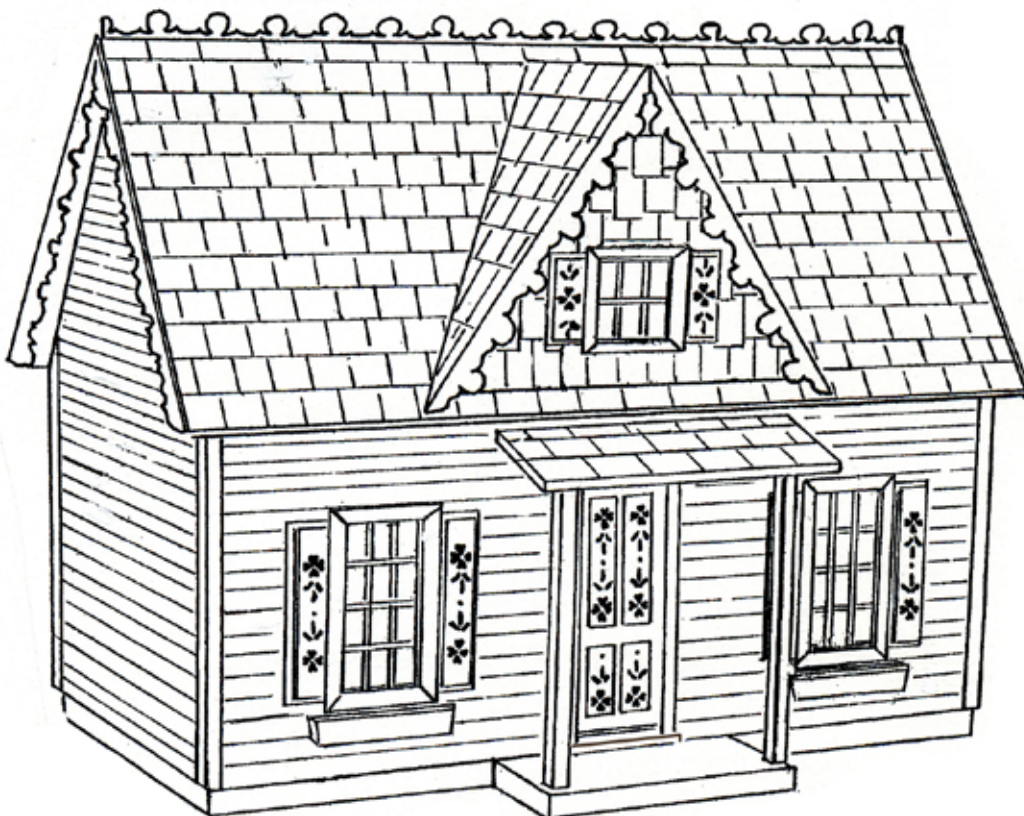

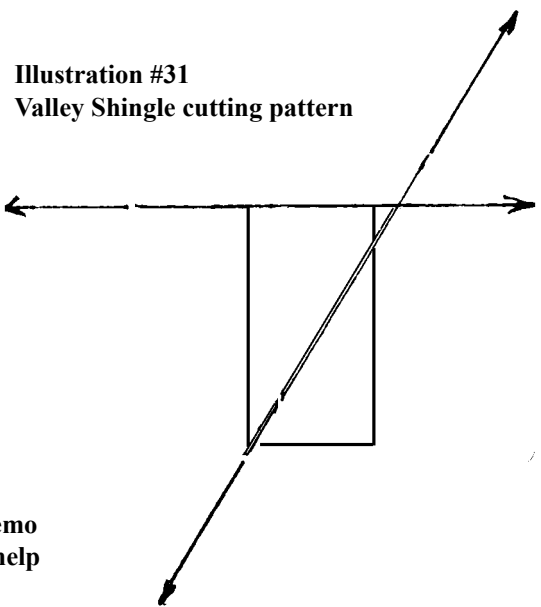
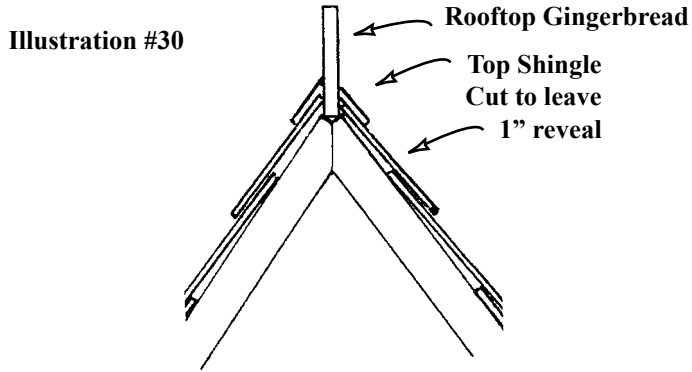

35. Install the Rooftop Gingerbread (Illustration #30 & 33)

G: Shingle The Roof:

There is a Shingling demo at www.realgoodtoys.help

Cut 40 Shingles that, when they are in pairs with the angles in the valley (illustration #38), the straight edge is straight up-and-down the roof (use Illustration #31 to get the angle).

Glue: Use a thick solvent based panel adhesive such as Liquid Nails**Macco* available in a caulking gun tube at building supply stores (read the ingredients to make sure it is a solvent-based adhesive... if it says "water clean-up, it will curl the shingles). Trim just a little of the end of the tube for a tiny hole, to give a thin bead of glue. Always use good ventilation with solvent based adhesives.

Illustration #32

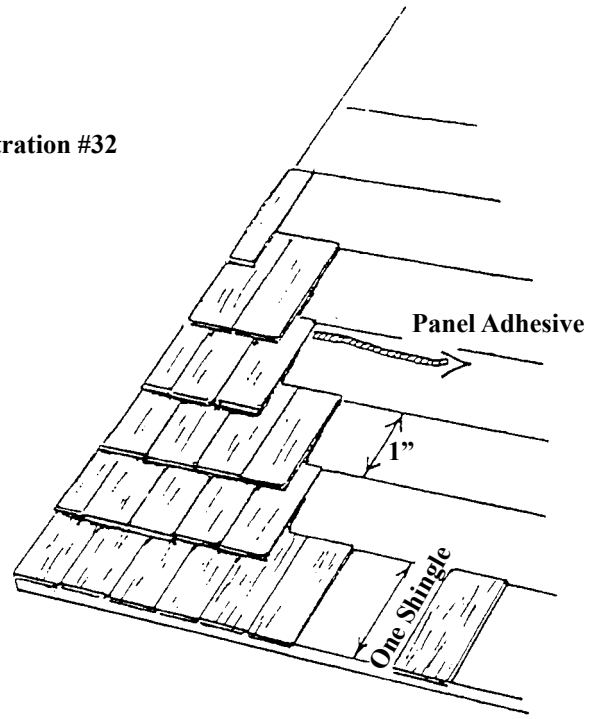

36. Apply a thin line of adhesive 1/8" below the lowest guideline all the way across the Roof. Press the top edge of a Shingle into the line of glue, squeezing out the excess. Hold the first Shingle steady and press another shingle into the adhesive, tight to the first. Hold the next Shingle and press in another... etc. all the way across the roof, cutting the last shingle to fit. The first row of Shingles is tight to the bottom, the rest line up with the guidelines. Finish each row before starting the next row. Put in a narrow shingle, if necessary to make the shingle row come out right.

37. Continue up the roof one row at a time. Start every other row with a half Shingle so that the seam between Shingles is offset 1/2 Shingle back and forth as you go up the roof. Use the pre-cut Shingles in the valley (Illus. #33). Cut the last row of shingles the right length (5/8") so that the reveal of all the other rows will be the same (1"). Glue the last row of Shingles to the Roof and to the Rooftop Gingerbread (Illustration #30).

38. Shingle the Back Roof and the Porch Roof.

E3591 Roof Top Gingerbread

Illustration #33 Valley Shingles

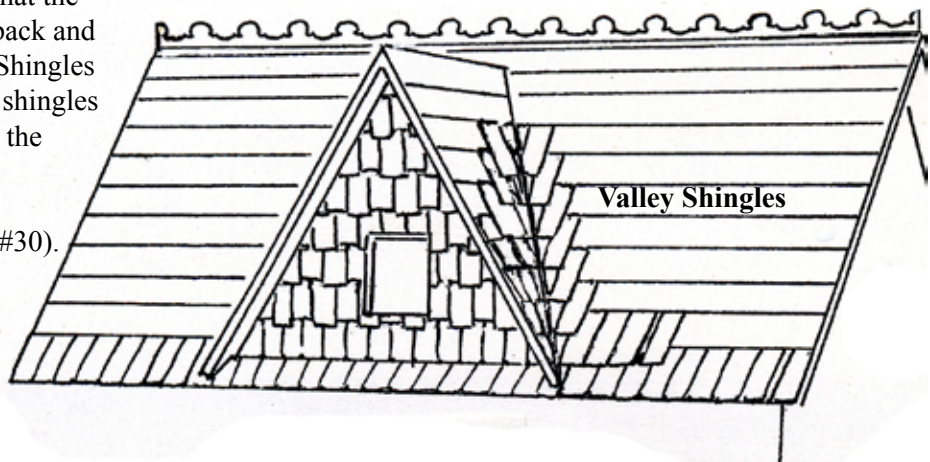

Finish the Outside

Special Feature

Gingerbread is Pre-Cut and Ready to Use

**Illustration #34
Gingerbread**

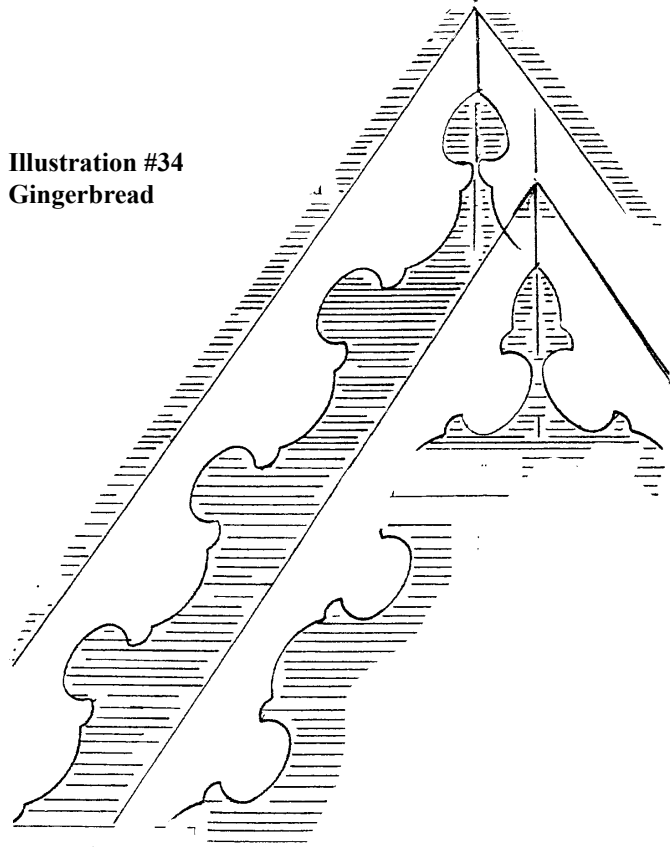

39. Paint and install the Gable Gingerbread to the edge of the Gable Roofs, covering the edges of the shingles.

40. Paint and install the Eave Gingerbread to the edges of the Roofs, covering the edges of the shingles.

41. Cut one end of four pieces of Stripwood to match the Stripwood angle pattern. (Illustration #35)

Paint and attach the Stripwood to the front and back face of the Sides (Illustration #36). Cut off the bottom edges to fit.

**Illustration #35
Stripwood cutting pattern**

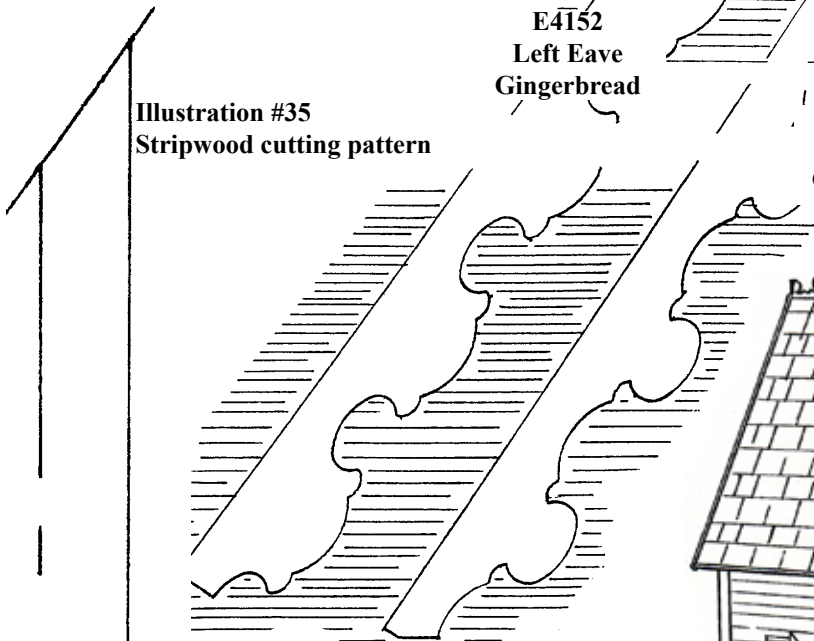

**E4154
Left Gable
Gingerbread**

Rooftop Gingerbread

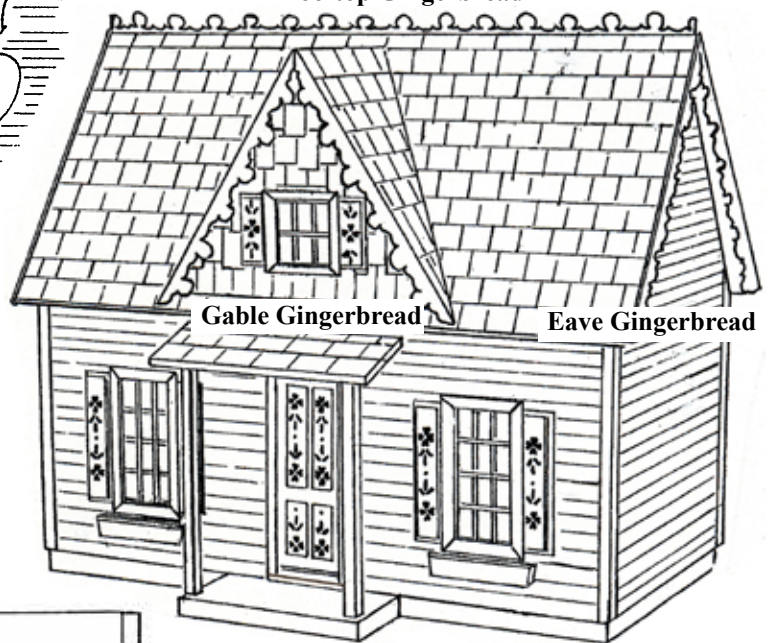

**Illustration #36
Stripwood placement**

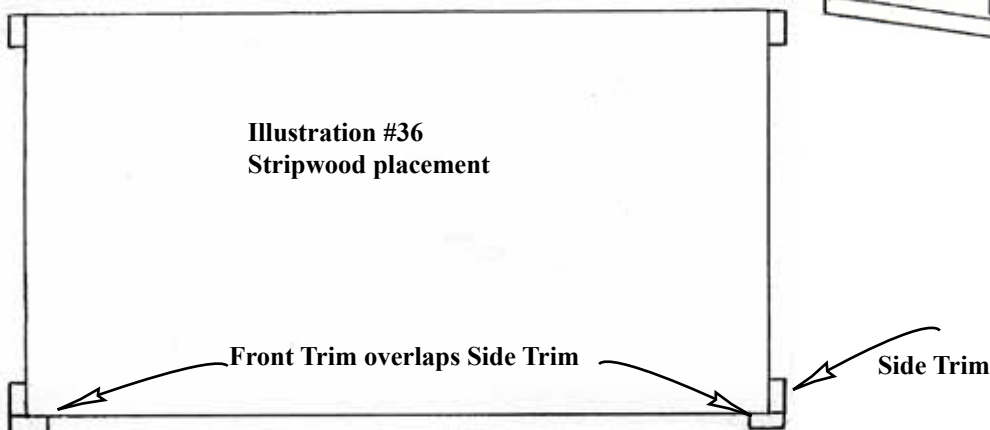

Finish the Inside...Plan Ahead!

Interior finishing involves so many choices! Will this house be a play-house or a display for miniatures? What accessories will be used and where will they go? Wiring? Wallpaper? Tile or carpeting? Every choice makes a difference in the order of finishing. Real Good Toys has provided materials for some basic interior work, but you may choose to do it differently.

- Make your choices
- Get your materials
- Test your layout

With the pieces in your hands, imagine the steps to get to where you want to be. Now you're ready for **your** order of interior finishing.

Here's the order that our assembly pro follows for tackling most custom interior finishing:

- Dividers
- Electrical wiring (using "tape" style wiring)
- Wallpaper
- Interior Window Trim
- Flooring
- Stairs
- Baseboard and crown moldings

Illustration #41: Stairs

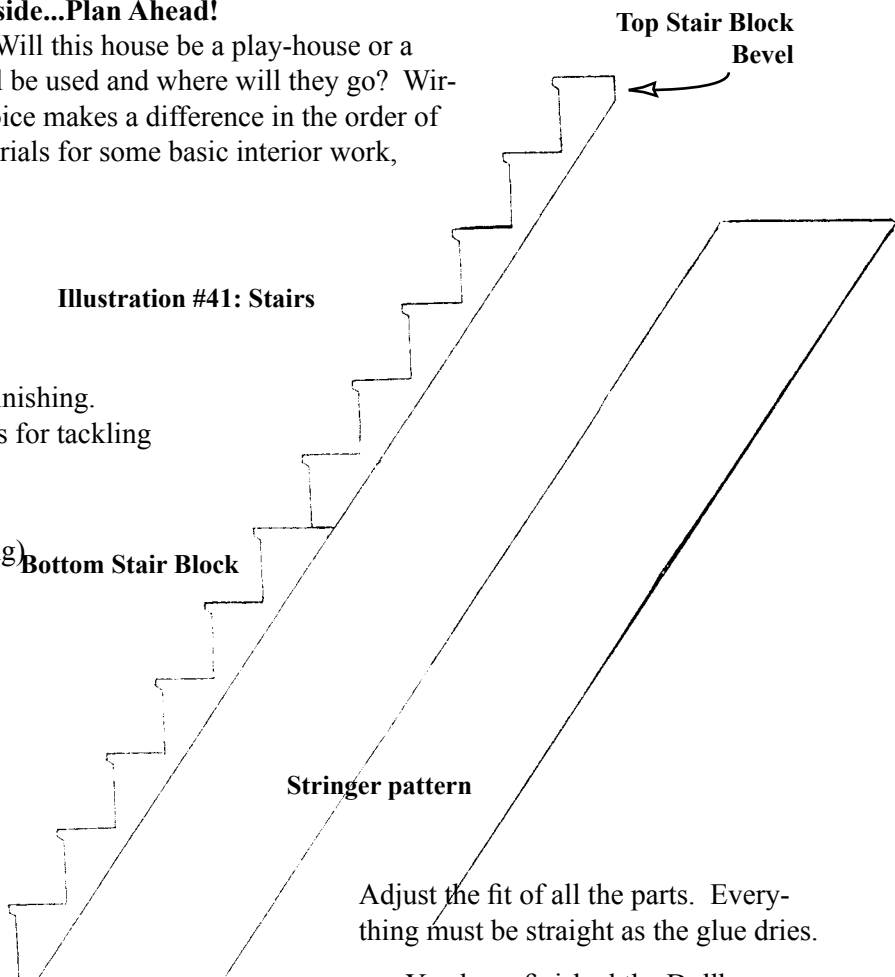

Adjust the fit of all the parts. Everything must be straight as the glue dries.

You have finished the Dollhouse assembly part of your project...

ENJOY THE REST

42. Divider and Attic Partitions are important for floor support, but they can go wherever you like. Try different layouts and test your furnishings before permanently installing the Dividers

43. Lay the window panes in the window cutouts. Glue the interior window frames in place

Glue the Door Interior Trim to the inside of the Door

44. Line up the Stringer with the pattern, and mark the cut. Cut the Stringer with a fine toothed saw.

45. Glue the Bottom and Top Stair Blocks together (Illustration #45). Without glue, test the Stair assembly in the stair hole. The stairs are tight to the wall and the top tread is flush with the floor.

Wait to permanently install the stairs until flooring and wallpapering are done.

Glue the stair assembly in place. Let dry.

Glue the Stringer to the side of the Stair assembly for support.

Cut the Stringer

