

Congratulations on your choice of a Real Good Toys product. Your kit has been precision made with meticulous care by our craftspeople using carefully selected materials. This Dollhouse will last for years, even generations, if heirloom care and attention is given during assembly. Take your time and read the instructions completely. If you have questions, ask the experts at your local Dollhouse store or at [info@realgoodtoys.com](mailto:info@realgoodtoys.com)

**Before you begin** - You have already opened the box and see all the parts organized in boxes and bundles. For the moment, keep them that way. There are important things to do before you open your glue bottle.

**Choose your color scheme.** Look at houses in your community, models in your local Dollhouse shop or at our website: [realgoodtoys.com](http://realgoodtoys.com); look at plan books from a paint store or architectural books at your library (a favorite is: *Painted Ladies* by Michael Larsen and Elizabeth Pomada). You will be painting some of the parts right away so get the paint now. Choose high-quality semi-gloss latex enamel paints for ease of use and durability.

**Prepare your space:** This dollhouse will spread out over a large area while it is being built. You will need a large flat tabletop for the house, several boxes to keep parts organized until they are needed, and several trays lined with waxed paper for holding small parts like windows and railings. A snap-lid box will keep your tools and supplies handy between building sessions.

**Measure and identify the parts:** The kit is packed in groupings that protect the parts, and that is how the Parts List is organized. As you measure and identify the parts, label them with sticky notes using the names from the parts list, and check them off the parts list so you know you have everything. Taking the time now to identify and organize the parts also makes them familiar so you will understand what the instructions intend as you read ahead.

- Plan ahead so you know where you are going
- Read ahead so you know how to get there
- Paint ahead so the parts will be ready when you need them

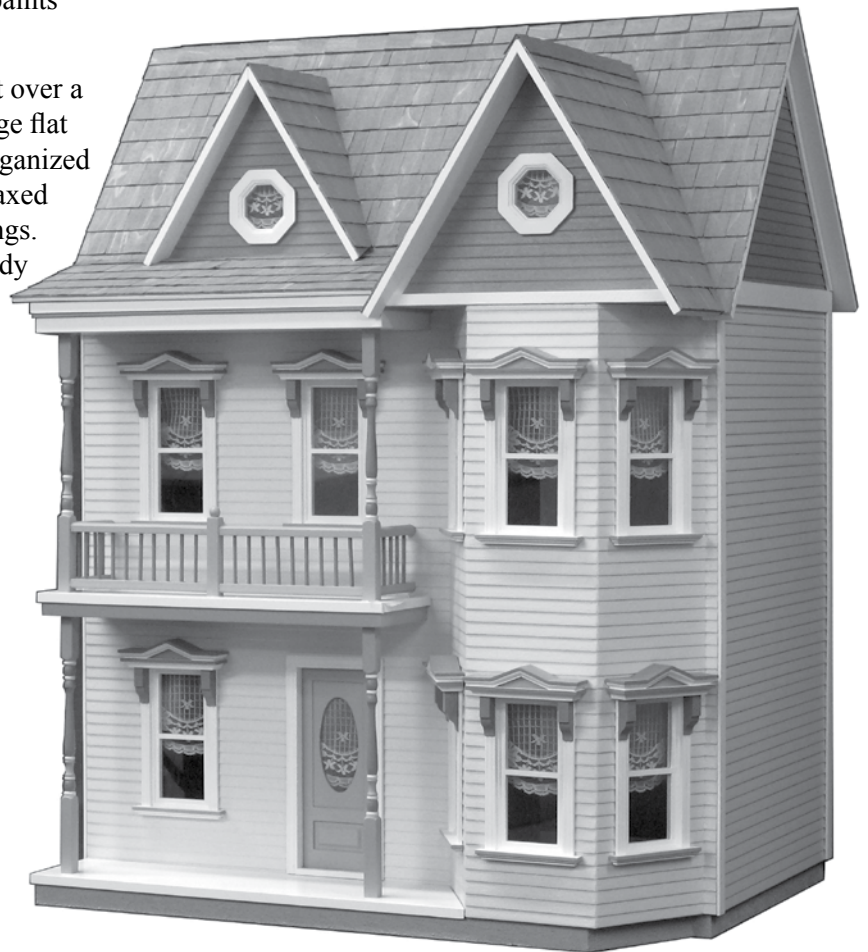

**Options:** [www.realgoodtoys.com](http://www.realgoodtoys.com) or your miniature dealer

6888: the "Best 1" Dollhouse Electrical Kit

Stucco Grit: Paint additive for foundation texture

Dye-1: Brown shingle dye

Dye-3: Grey shingle dye

SC: Copper flashing

1015: 6-panel interior door fits the Divider

J-FK Interior finishing materials: Baseboard and crown moldings & stairway banisters and landing rails.

This kit will accommodate 1" Scale furniture

### Tools and Supplies:

Tape measure or ruler, Pencil, Sticky notes (like PostIts®)

White glue (like Aleene's Tacky Glue®) for all construction

Solvent-based Panel Cement for shingles

Masking tape, Utility knife or coarse file

Fine tooth saw (razor saw (like X-Acto®) or a hacksaw)

Painting Supplies, Sandpaper (especially 320gr)

Waxed paper

PostIts®, Aleene's®, and X-Acto® are trademarks of their manufacturers and have no affiliation with Real Good Toys

Not suitable for children under 13 years of age  
California 93120 compliant for formaldehyde phase 2



Identify the parts: Open one bundle at-a-time.

Measure each part and find it on the parts list.

Label the parts and group them by the 'instruction section letter' at the end of each part's name(#).

These groups are how the parts will be used.

**Parts List** (measurements are approximate and are for identification purposes only)

- 2 E 3606 Side<sup>C</sup> (3/8<sup>Milled</sup>): 277/8 x 113/4; Angled, Grooves
- 1 E 8004 Bay Mid Floor<sup>C</sup> (3/8): 75/8 x 311/16; Angled
- 1 E 3614 Attic Partition<sup>B</sup> (3/8): 81/2 x 61/8; Angled
- 1 E 8008 Left Front<sup>C</sup> (3/8<sup>Milled</sup>): 1819/32 x 1315/16; Grooves, Cutouts
- 1 E 8003 Top Floor<sup>C</sup> (3/8): 22 x 157/8 Stair Hole
- 1 E 3638 (800) Shingles<sup>AG</sup> (T1004)
- 1 E 8012 Front Roof<sup>F</sup> (1/4): 237/8 x 115/32; Beveled, Cutouts
- 1 E 8000 Rear Roof<sup>F</sup> (1/4): 237/8 x 13/8 Beveled
- 1 E 8006 Gable Front<sup>F</sup> (1/4<sup>Milled</sup>): 71/8<sup>tall</sup> x 9<sup>base</sup> Triangle, Window Cutout
- 2 E 3615 Divider<sup>C</sup> (3/8): 9 x 113/4; Doorway\*
- 1 E 8018 Balcony Floor<sup>E</sup> (3/4): 121/4 x 31/2
- 3 E 8009 Bay Front<sup>C</sup> (3/8<sup>Milled</sup>): 1819/32 x 41/4; Bevels, Grooves, Cutouts
- 1 E 8001 Base Floor<sup>C</sup> (1/4): 22 x 117/8
- 1 E 8014 L. Gable Roof<sup>F</sup> (1/4): 99/16<sup>top</sup> x 95/8<sup>tall</sup>; Angled, Beveled, Inlet
- 1 E 8015 R. Gable Roof<sup>F</sup> (1/4): 99/16<sup>top</sup> x 95/8<sup>tall</sup>; Angled, Beveled
- 1 E 8016 L. Dormer Roof<sup>F</sup> (1/4): 55/8<sup>top</sup> x 77/16<sup>tall</sup>; Angled, Beveled
- 1 E 8017 R. Dormer Roof<sup>F</sup> (1/4): 55/8<sup>top</sup> x 77/16<sup>tall</sup>; Angled, Beveled
- 1 E 8007 Dormer Front<sup>F</sup> (1/4<sup>Milled</sup>): 53/4<sup>tall</sup> x 71/8<sup>base</sup> Triangle, Window Cutout
- 1 E 8005 Bay Base Floor<sup>C</sup> (1/4): 75/8 x 311/16; Angled
- 1 E 8002 Mid Floor<sup>C</sup> (3/8): 22 x 117/8 Stair Hole

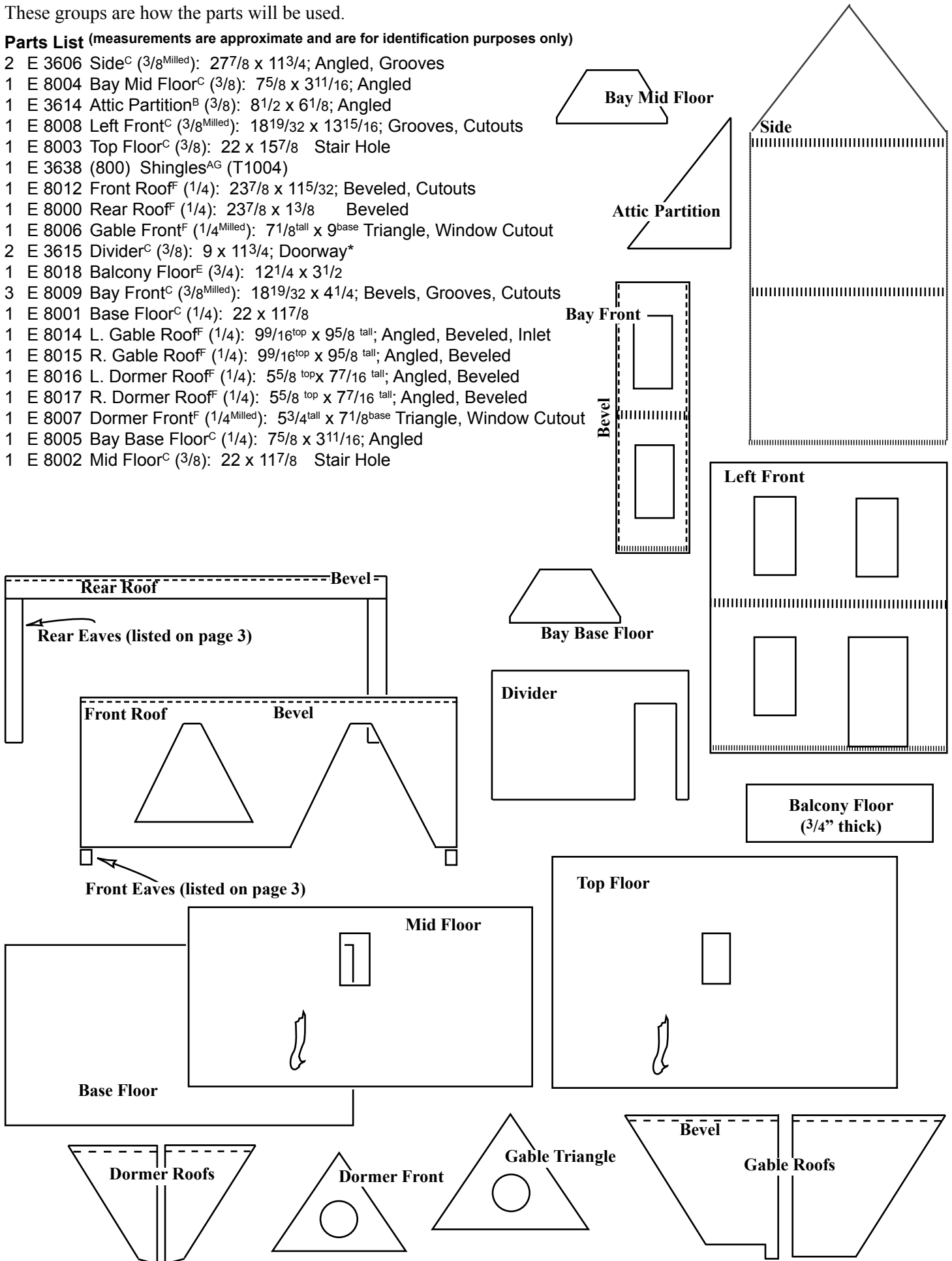

Box #1

- 1 E 8020 Porch Floor<sup>E</sup> (1/4): 15<sup>5</sup>/<sub>16</sub> x 3<sup>1</sup>/<sub>2</sub>; Angled
- 2 E 3616 Stringer<sup>I</sup> (1/8): 3/4 x 10<sup>13</sup>/<sub>16</sub> <sup>edge//</sup>
- 1 E 8021 Porch Roof<sup>F</sup> (1/8): 14<sup>1</sup>/<sub>4</sub> x 4<sup>3</sup>/<sub>4</sub>; Angled
- 1 E 8010 Right Front<sup>C</sup> (3/8<sup>Milled</sup>): 18<sup>19</sup>/<sub>32</sub> x 29<sup>29</sup>/<sub>32</sub>; Grooves
- 1 E 8019 Balcony Ceiling<sup>E</sup> (1/4): 12<sup>1</sup>/<sub>2</sub> x 3<sup>1</sup>/<sub>2</sub>
- 1 E 8023 Balcony Facia<sup>E</sup> (1/8): 12<sup>1</sup>/<sub>2</sub> x 5/8
- 1 E 8024 Back Foundation<sup>D</sup> (1/2): 3/4 x 22
- 1 E 8025 Front Foundation<sup>D</sup> (1/2): 3/4 x 19 3/8; Angled on one end
- 3 E 8035 Middle Foundation<sup>D</sup> (1/2): 3/4 x 14<sup>5</sup>/<sub>8</sub>
- 1 E 8026 R. Side Foundation<sup>D</sup> (1/2): 3/4 x 11-
- 2 E 3610 Rear Eave<sup>F</sup> (1/4): 10 x 13/8
- 3 E 8029 3/32 Trimstock<sup>H</sup> (3/32 x 3/32): 21±; Porch Banding
- 2 E 8030 5/16 Trimstock<sup>E</sup> (5/16 x 1/8): 8<sup>1</sup>/<sub>2</sub>; Porch Spacer & Banding
- 4 E 8031 5/16 Trimstock<sup>H</sup> (5/16 x 1/8): 21±; Eave Trim & Porch Banding
- 4 E 8032 1/2 Trimstock<sup>H</sup> (1/2 x 3/32): 21±; Side Trim
- 2 E 8033 3/4 Trimstock<sup>H</sup> (3/4 x 3/32): 12<sup>1</sup>/<sub>8</sub>; Side Banding
- 1 E 8027 Inset Foundation<sup>D</sup> (1/2): 3/4 x 27/8
- 1 E 8028 Bay Foundation<sup>D</sup> (1/2): 3/4 x 4<sup>1</sup>/<sub>4</sub>; Angled on both ends
- 2 E 8011 Porch Roof Triangle<sup>F</sup> (3/8): 1<sup>3</sup>/<sub>8</sub><sup>tall</sup> x 3<sup>7</sup>/<sub>16</sub><sup>base</sup>
- 2 E 8013 Front Eave<sup>F</sup> (1/4): 15<sup>15</sup>/<sub>16</sub> x 11<sup>11</sup>/<sub>16</sub>
- 2 E 8022 Balcony Facia<sup>E</sup> (1/8): 3<sup>1</sup>/<sub>2</sub> x 5/8
- 2 E 3617 Bottom Stair Block<sup>I</sup> (6 step): 2<sup>1</sup>/<sub>4</sub>
- 2 E 3618 Top Stair Block<sup>I</sup> (6 step, Bevel): 2<sup>1</sup>/<sub>4</sub>
- 4 RGT5 Porch Post<sup>B</sup> (U 3005): 8<sup>1</sup>/<sub>2</sub>" Turnpost
- 4 E 8036 5<sup>1</sup>/<sub>8</sub> Rail<sup>B</sup>
- 4 E 8037 2<sup>5</sup>/<sub>8</sub> Rail<sup>B</sup>
- 34 E3622 1/8 Dowel<sup>B</sup>: 1<sup>3</sup>/<sub>4</sub>
- 1 E 8034 Balcony Newel<sup>B</sup> (7/16 x 7/16 pine): 2<sup>1</sup>/<sub>2</sub>" Plain post
- 1 E 3960 3/8 ball<sup>B</sup>
- 1 U 1119 Oval Lite Door<sup>H</sup>
- 9 5042C Victorian Window<sup>H</sup>
- 2 U 2018 Octagonal Window<sup>H</sup>

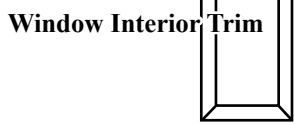
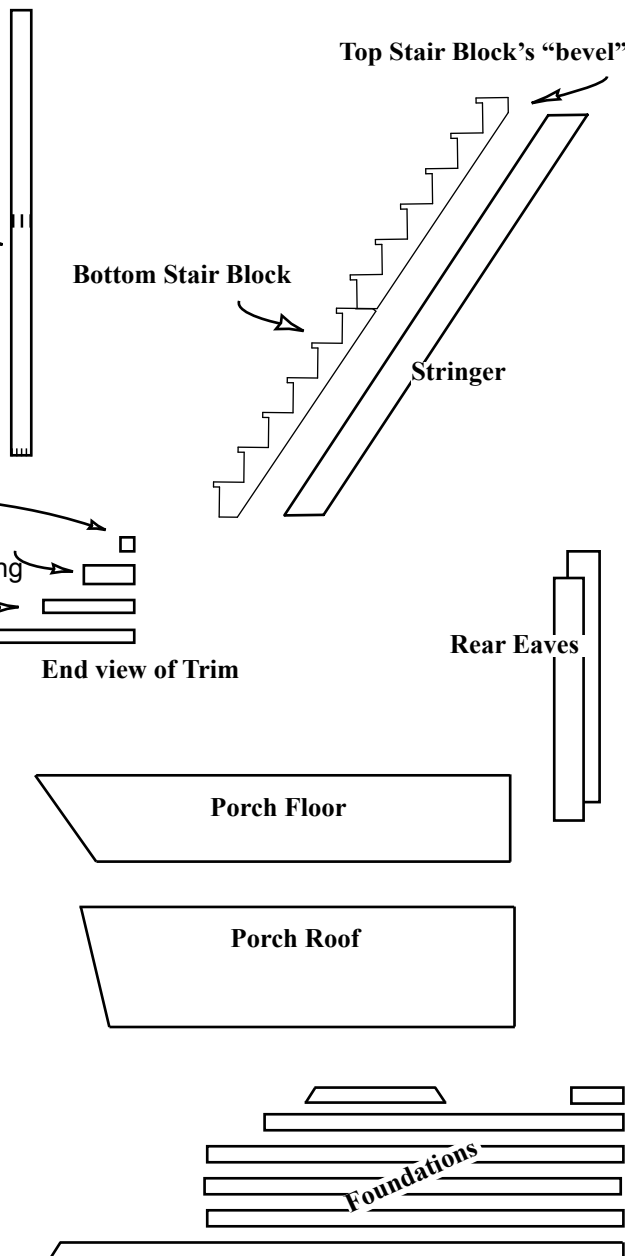

**Assembly Notes:**

A large, clutter-free, well-lighted work area is helpful during assembly, but a flat work surface is essential.

**Read the instructions carefully;** look at each of the illustrations. *!With the parts in your hands!,* think the assembly through before you proceed.

**Test fit** each time you are ready to glue a piece in place...then you'll know you have it right.

If more tape or a helper is needed, it's good to know that before the parts have glue on them.

Don't be stingy with glue or tape; use generous amounts. Always wipe off excess glue immediately.

Keep one damp rag and one dry rag handy all the time.

Waxed paper keeps small parts or sub-assemblies from sticking to the table as they are being glued or painted.

Have weights available for holding things tight as glue joints dry (stacks of books, gallons of pure Vermont Maple Syrup - anything heavy)



## Assembly Notes, continued:

**This kit should be assembled using masking tape and weights as the only holding devices. RGT does not recommend the use of nails on this house.**

**Glue** the body of your dollhouse together with white, water clean-up glue that dries clear. Do not use instant-bond (super glue), fast-tack, rubber cement, silicone, or hot melt glues. They are all used in some wood applications, but they all have some characteristic that makes them un-desirable for the body of your dollhouse. Carpenter Glue works well, but glue-smear dries yellow or tan; many of the things you glue onto the house are pre-painted – extra glue will show. I use Aleene's Original Tacky Glue® for all house body assembly. Make sure everything is straight and flat as glue dries... That's the shape that will be permanent.

**A: Getting Started:** Do these things before the house assembly

**Square the corners** of the window, door, and stair holes with a utility knife or double-cut coarse file - each cutout has a rounded corner left over from the tool that made it.

Make two cuts in each corner from the outside (one from each direction), then cut from each direction on the inside to cut away the rounding in the corner so the window, door, or stairs will fit.

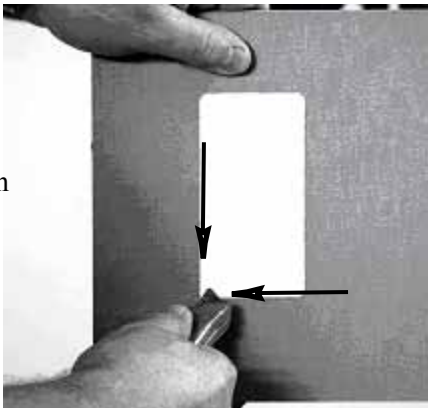

**Stain the Shingles:** Our pro uses Real Good Toys' Shingle Dye (available through your Real Good Toys miniature dealer) when dyeing the shingles for this house.

Batch dye or stain the shingles several days ahead of time so they will be dry when the time comes to use them.



**OnLine Support:** There are many photos of this house under construction as well as tips, techniques, and extra help with your dollhouse project at: [www.realgoodtoys.help](http://www.realgoodtoys.help)

Glue the shingles on with glue that doesn't have any water in it! If the glue says "water clean-up", it will curl the wooden shingles. Look carefully at the glue you intend to use to be sure it is solvent-based (solvent based glues have warnings about flammability), or use hot-melt glue (and watch out for the burns). I use a "construction adhesive" that comes in a caulking-gun tube from a hardware or building supply store. Check ingredients and warnings!

If you Wallpaper, use Yes® craft paste (for bookbinding or collage) or "border" paste.

Brush paste on the wallpaper, then the wall, and finally smooth the wallpaper into position.

When glue is drying, skip ahead to up-coming assembly steps and prepare the parts that will be used

Before you begin, read the "Finish the Inside" section on the last page.

**Questions?** Ask the experts at your local Dollhouse store or at [info@realgoodtoys.com](mailto:info@realgoodtoys.com)

**Paint all the walls;** do not paint the edges.

Sand the clapboard *one course at a time*, and re-paint. Use high quality semi-gloss latex enamel, sanding between coats with 320 grit sandpaper. Avoid old gloppy paint and poor quality paint brushes.

Everything gets painted before attaching it to the house-body. Look for the paintbrush symbol as you preview the instructions.

**Foundation Paint** (page 9): For the show models we assemble here at Real Good Toys, we paint the Foundations with one coat of regular paint, then a coat of paint mixed with Stucco Grit. Keep the mixture well stirred and apply with a foam brush in short swirls or slaps.

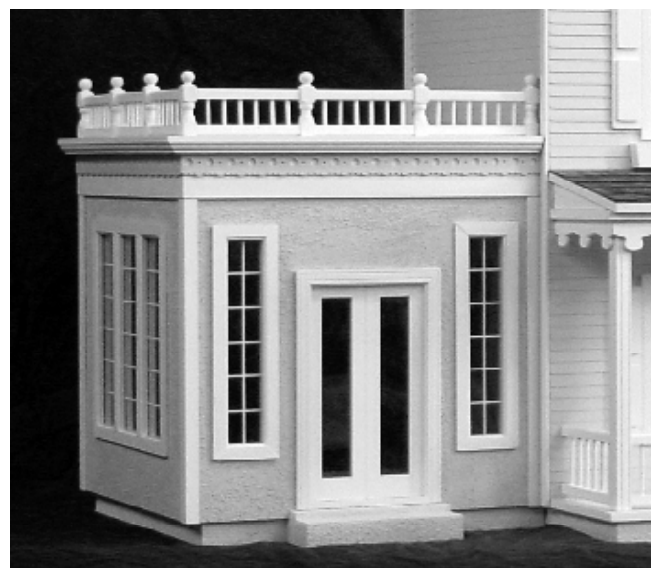

JM 66 Junior Conservatory

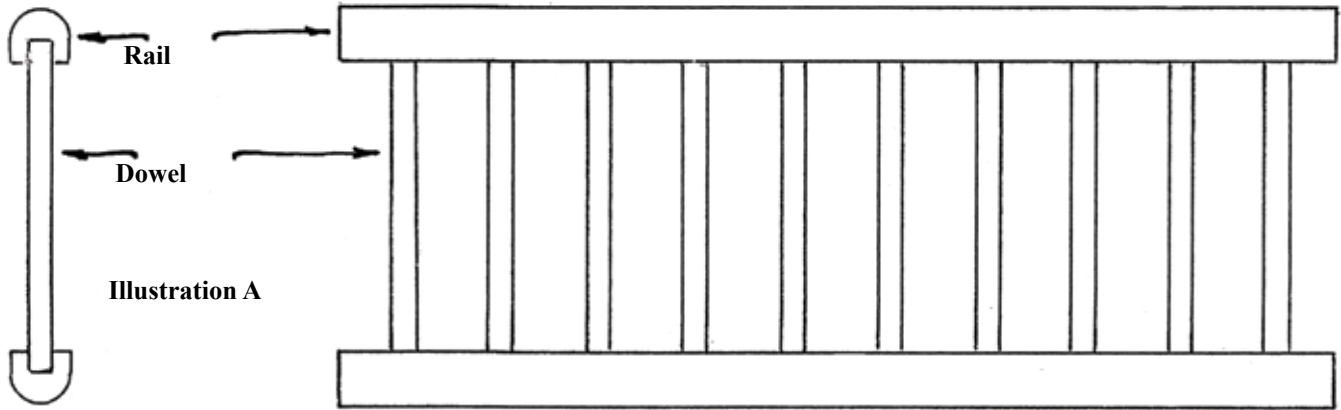

Illustration A

**Porch Posts and Balcony Railings:** Paint, then assemble the Porch Posts, Newel, and the Balcony Railings in between house assembly steps (the ones that make you stop to let glue dry). Keep coming back to work on these parts so they will be ready when assembly of your house is ready for them.

**Balcony Post, Newel and Railing Assembly**

(use painted parts, but scrape a bare spot on the posts where the rails will glue to them)

A. Match the Rails into assembly pairs. Place your Rails on the Illustration, lined up on the illustration's left edge. Put a dab of glue in the Rail's groove by each Dowel location. Push a Dowel into the groove at each spot. Be sure all the Dowels are even, straight, and square. Let the glue "stiffen up" for a few minutes.

B. Squeeze on the second Rail of the assembly pair feeding the Dowels in one at a time at the Dowel location. Final adjust the Dowels with the ends of the Rails "squared up" against the Attic Partition (like Illus. E). Let the glue dry.

C. Glue each of the 2<sup>5</sup>/<sub>8</sub>" Railing to a Turnpost, spaced above the table with a shingle on each corner, and spaced from the "Stop" (use the Balcony Floor for the "stop") with a 1/8" Dowel: 1 3/4". Use the Attic Partition to make sure the Posts are square with the stop. Let the glue dry.

D. Glue together the Newel Post and 3/8" Ball. Let the Glue Dry.

E. Glue together the Balcony Front Railing Set as shown. Space the Railings above the table with a shingle on each corner, and away from the "Stop" with a 1/8" Dowel: 1 3/4". Use the Attic Partition to make sure the Posts are square with the stop.

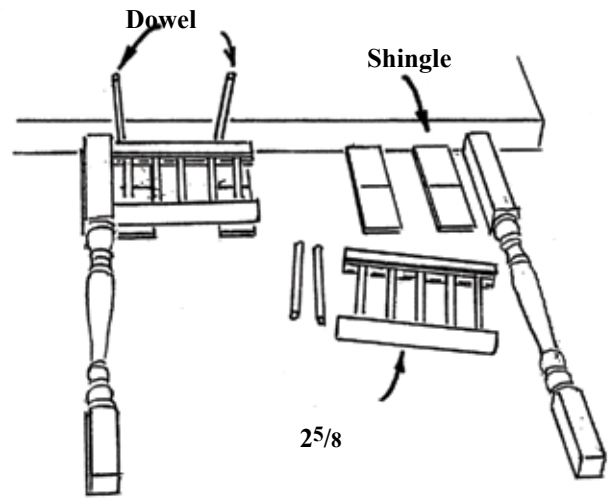

Illustration C

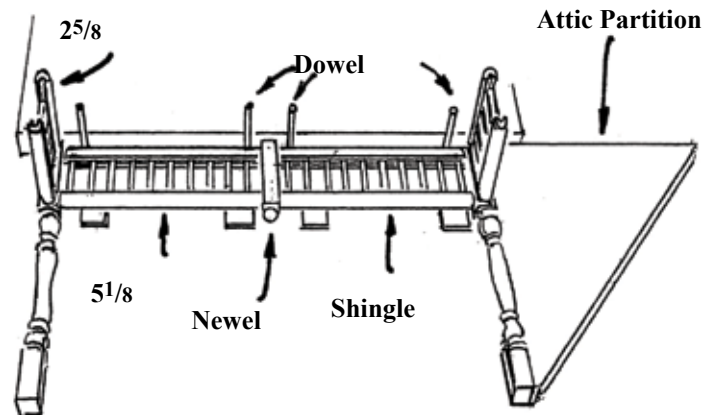
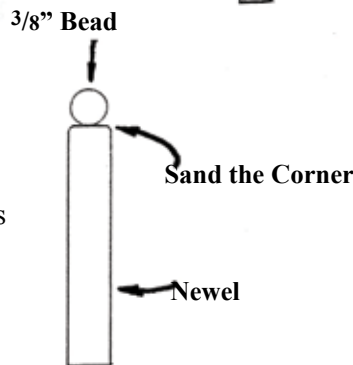

Illustration E

### Assemble the Housebody:

**Preview:** In this section, you will square the openings, Identify the top of the floors, and glue together the Floors and Side Panels. Finish to #11 before letting the glue dry.

- 1. Square the corners of the windows, door, and stair-way openings (Illustration #1).

Don't skip step 2!

- 2. When you are looking at the Middle floor with the stair hole closer to you and closer to the right edge, you are at the front edge, looking at the top surface. Put a piece of tape on the top-back (the back edge is away from you) of the Middle floor. Lay the Middle Floor (with the tape up) on the Top Floor, lined up at the back edge and at the ends. If the stair hole lines up exactly, you have identified the top of the Top Floor. If not, then switch the Top Floor around until the stair hole does line up with the Middle floor. Mark the top-back of the Top Floor with a piece of tape. (Illustration #2).

- 3. (Illustration #3) Temporarily tape together the Dividers, making a "stand" that will be used as a floor support during assembly. Spread glue in the grooves of one Side panel.

Now is a great time for an extra pair of hands.

- 4. Stand the Middle Floor on end (check the orientation again) in the middle groove of the Side. Tape the Middle Floor to the Stand. (Illustration #4) Set the Top Floor in the top groove; tape it to the "Stand".

- 5. Adjust and check all the parts. The Floors must line up at the back edge with the Side. The Middle Floor overhangs the front of the Side by 1/8". Glue and tape the other Side panel to the Floors (Illustration #5).

Wiring is easiest if some of the steps are done along the way. Visit [www.dollhousewiring.com](http://www.dollhousewiring.com) and plan your wiring now.

Illustration 1

Square the corners

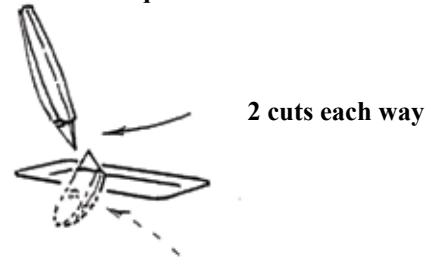

Illustration 2

Tape marks the Top-Back

Don't skip this step!

Stair Holes line up exactly

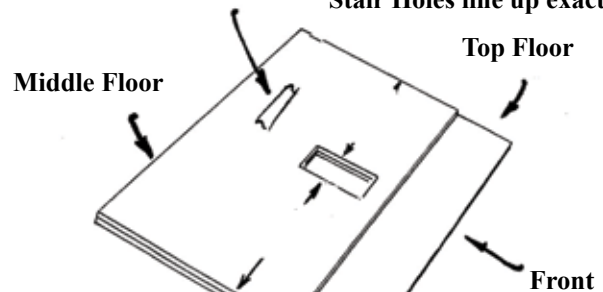

Illustration 3

Temporary use of the Dividers as a "Stand"

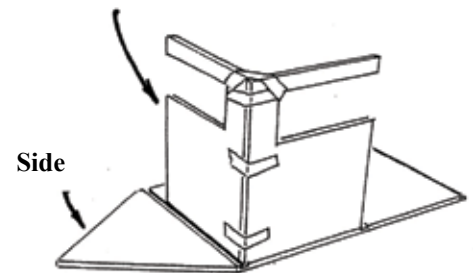

Illustration 5

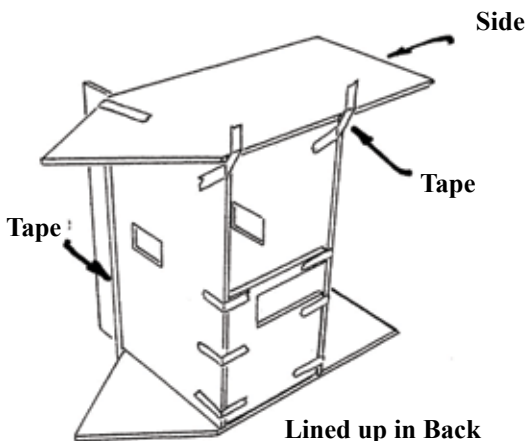
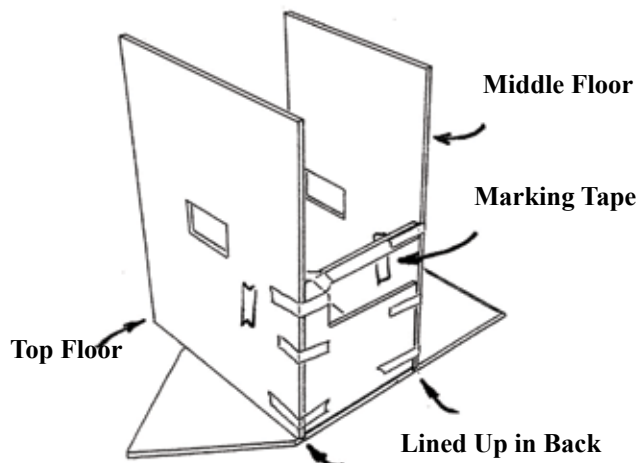
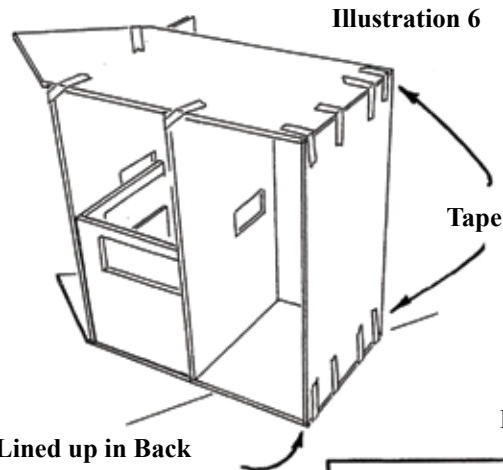

Illustration 4



6. Glue and tape the Base Floor into the Base Floor Groove. Make extra-sure that the Base Floor is pressed to the top-edge of the groove. (Illustration #6) Slide the Housebody to overhang the worktable so you can fully tape the Right Side to the floors.



7. Lay the housebody down on its BACK. Without glue test the Left Front in place on the house to see where it touches. Spread glue in the grooves and the top edge of the Left Front. Spread glue on the front edge of the Left Side. Set the Left Front in place on the housebody, lined up CAREFULLY at the base of the left edge. Tape the Left Front to the Base Floor (push the base floor fully into the groove). (Illustration #7)

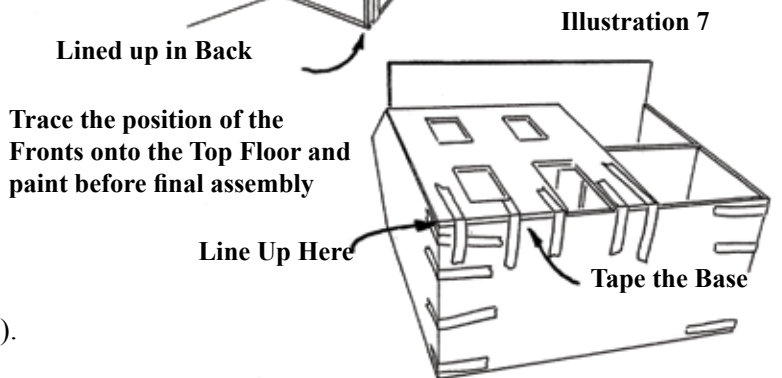

8. Start at the base and line up the Sidewall with the edge of the Front all the way from the base to the top, taping as you go. Take care to get the walls to really line up. This is the operation that straightens your house.

Trace the position of the Fronts onto the Top Floor and paint before final assembly

9. Remove and un-tape the Dividers (the "Stand"). Tape, *don't glue*, a Divider to the Left Front with the Divider lined up at the back edges of the floors (this locates the top edge of the Left Front). Illustration #9)

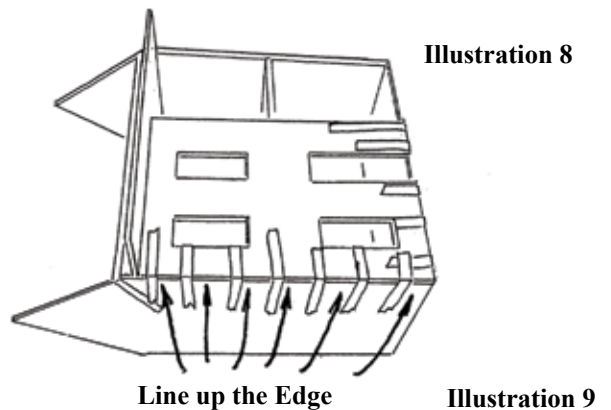

10. Glue and tape the Right Front to the floors and Right Side (Illustration #10).

**Review:** Make sure all parts are in place and all the joints are tight.

- Check the position of the stair holes: closer to the right front, and lined up with each other.
- The Base Floor is tight to the groove-top.
- The house is straight.
- The Bay Floors fit (a loose fit) between the fronts

11. Weight the Top Floor as the glue dries.

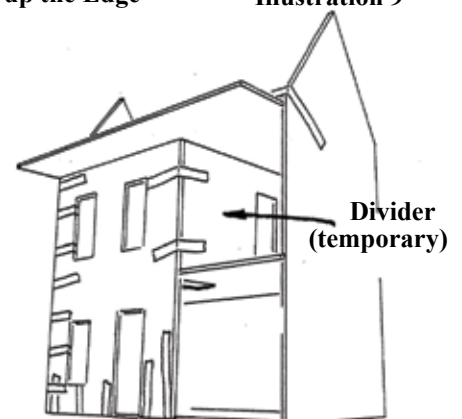
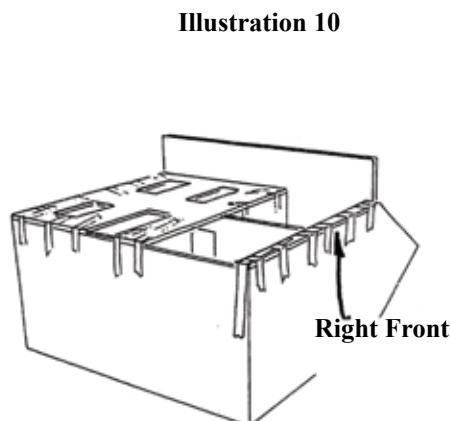
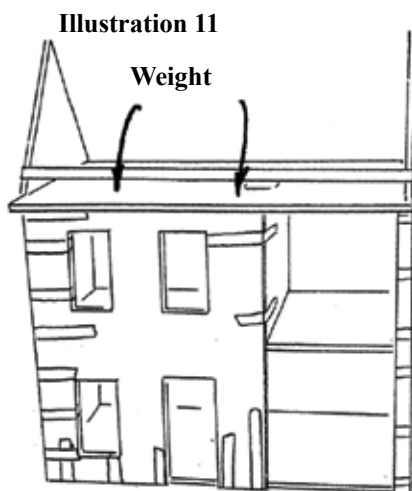

**Note**  
Don't forget the Right Front



**Preview:** In this section, you will build the Bay.

12. Glue and tape the Bay Floors to the house floors, centered between the fronts, and lined up carefully on top. Illustration #12

13. Glue and tape the Bay Walls together, to the Bay Floors, and to the Top Floor. Illustration #13

14. Tape the Bay Walls to the Bay Base Floor  
Tape the Bay Walls through the windows to the inside of the house walls (Illustration #14).

Without glue, tape the Porch Base Floor to the housebody to guarantee the fit with the Bay Walls (Illustration #15).

15. Adjust the fit of the Bay Walls:

- Check on the inside where the Bay Walls meet the house walls. Adjust the fit to make them even from top-to-bottom on both sides.
- Check on the outside along the right edge of the Bay. Adjust the fit if necessary to make the exposed face of the Right Front Wall the same top-to-bottom.
- Check that the top of the Center Bay Wall sets back evenly below the edge of the Top Floor.
- Make sure everything is straight and tight, then weight the Top Floor as the glue dries.

Illustration 12

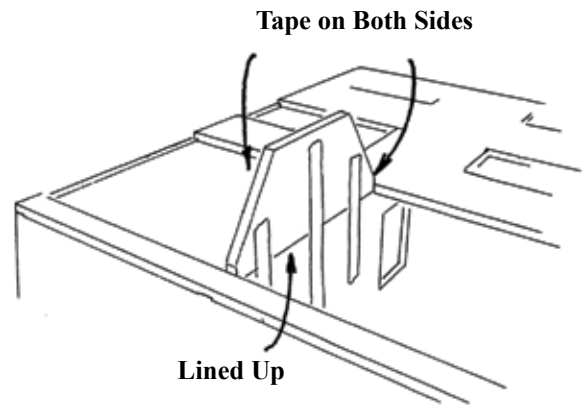

Illustration 13

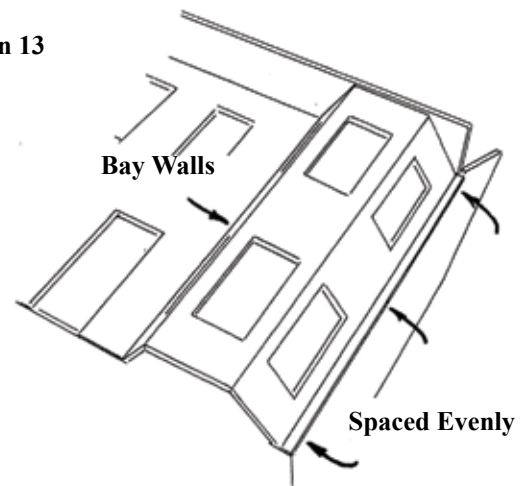

Illustration 15

Spaced Evenly

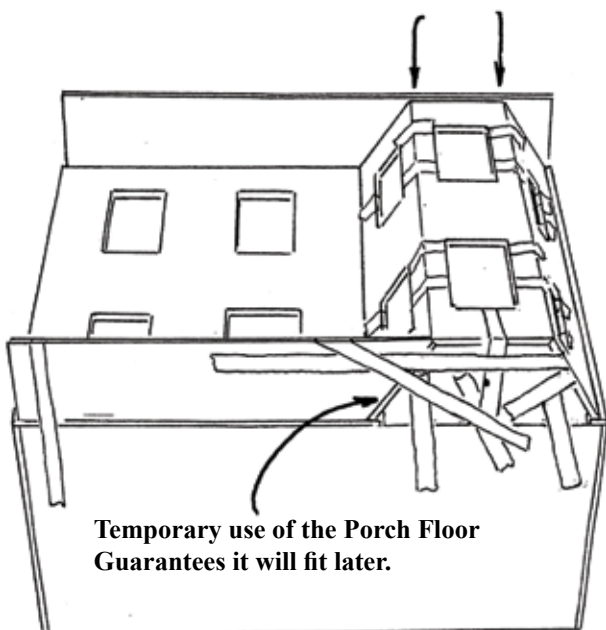
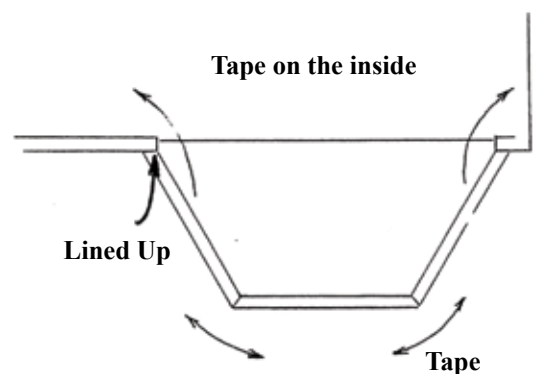

Illustration 14





Wiring is easiest if some of the steps are done along the way.  
 Visit [www.dollhousewiring.com](http://www.dollhousewiring.com) and plan your wiring now.

**Assemble and Attach the Foundation:**

- 16. Mark the length of the 27/8" Inset Foundation onto the 22" Back Foundation (Illustration #16).

*\*\*Be sure to complete Step 20 before letting the glue dry.*

Illustration 16

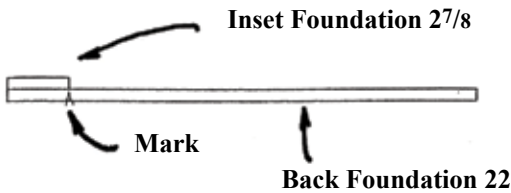
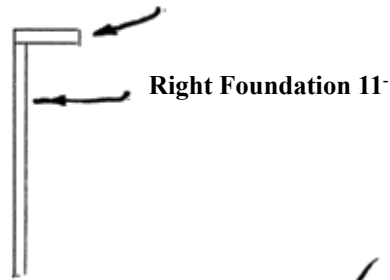

Illustration 17A

27/8



- 17. Glue and tape together the Foundation following Illustrations #17A, B, and C; make sure they are flat, top-and-bottom. Test, but do not glue in the Bay Foundation (Illustration #18) until the glue is dry.

Illustration 17B

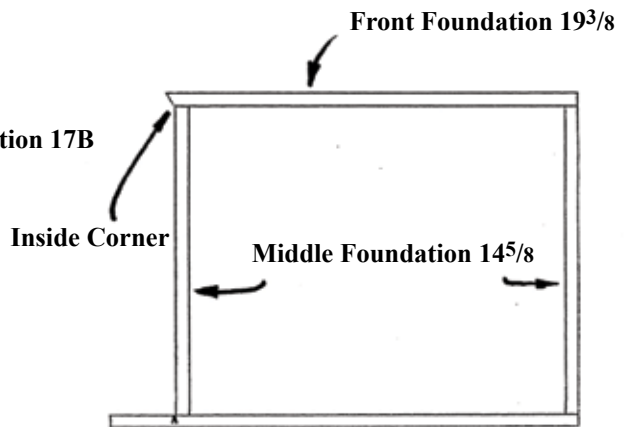

- 18. Glue and tape the Bay Foundation in place.

Pro Tip: Paint the house, foundation, and Porch Base Floor before attaching the house to the foundation. See step 19.

Illustration 17C

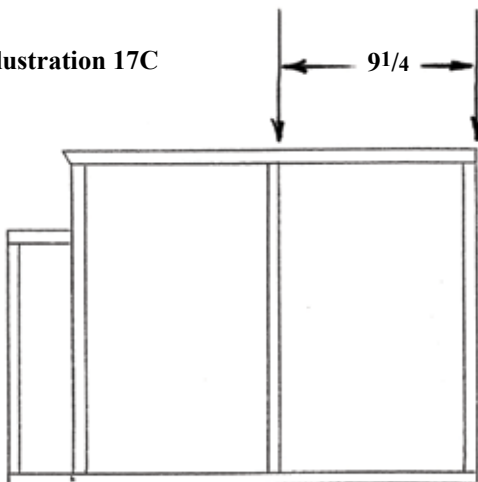

Line Up the Middle Foundation with the Mark

Illustration 18

Bay Foundation 4 1/4

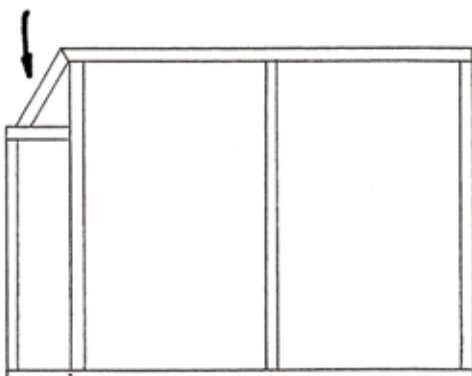
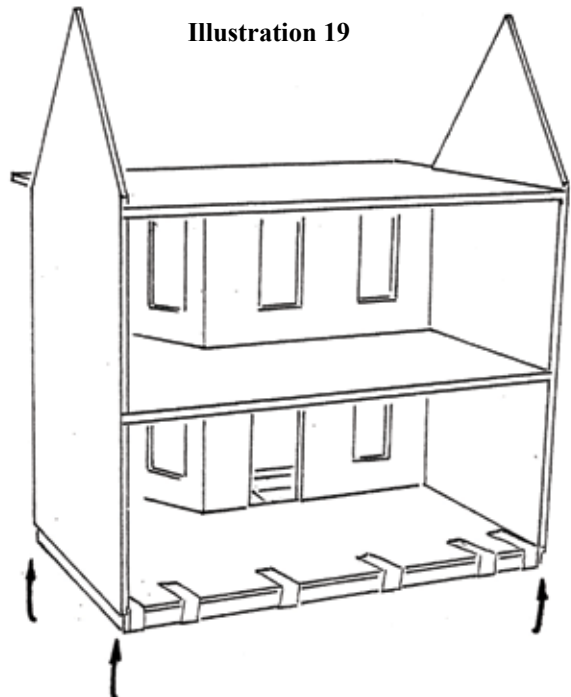

Illustration 19



- 19. Glue, tape and weight the House to the Foundation, lined up in the back, and spaced evenly elsewhere.

**Complete step #20 before letting the glue dry.**

**Porch Assembly:**

The parts used in this section should be painted ahead of time. If they have not been painted, do so now.

**Preview:** In this section, you will assemble and install the Porch.

□20. Glue, tape, and weight the Porch Base Floor to the Foundation and housebody, tight to the housebody, and lined up with the Foundation's edges. Let the glue dry.

□21. A. Set the Balcony Floor on the Porch Base Floor, spaced  $\frac{3}{8}$  from the left edge of the house with the Attic Partition. Lightly mark the Porch Base Floor on both edges of the Balcony Floor at the front. Remove the Balcony Floor.

B. Set the Balcony Railing set on the Porch Base Floor with the  $2\frac{5}{8}$ " Railings touching the wall, and centered side-to-side between the marks. Lightly trace the position of the two  $8\frac{1}{2}$ " Turnposts onto the Porch Base Floor. Remove the Balcony Railings.

□22. A. Tape (no glue) the two pieces of  $8\frac{1}{2}$ " Trimstock to the wall. Glue two Porch Posts ( $8\frac{1}{2}$ " Turnposts) to the Porch Base Floor lined up with the Turnpost marks (21B. above).

B. Glue the Balcony Floor to the House and to the Porch Posts (not to the Trimstock), spaced  $\frac{3}{8}$  from the house's left edge with the Attic Partition. Without glue, put the Balcony Railing Set on the Balcony Floor, centered side-to-side. Adjust the 1<sup>st</sup> floor Porch Posts to line up below the Posts in the Balcony Railing Set. Square up the Porch Posts with the Attic Partition. Let the glue dry.

□23. A. Lay the Balcony Ceiling up-side-down on the Balcony Floor. Put the Balcony Railing Set on the Balcony Ceiling, centered side-to-side. Lightly mark the position of the Porch Posts. Remove the Balcony Ceiling.

B. Glue the Balcony Railing Set to the Balcony Floor and to the house.

C. Tape the  $8\frac{1}{2}$ " Trimstock to the wall. Glue the Balcony Ceiling to the house and Turnposts (not to the Trimstock) spaced  $\frac{3}{8}$  from the left edge with the Attic Partition. Adjust the tops of the Porch Posts to the marks. Let the glue dry.

□24. Lay the house on its back. Glue and tape the Balcony Facia to the Balcony Ceiling and to the underside of the house Top Floor. Let the glue dry.

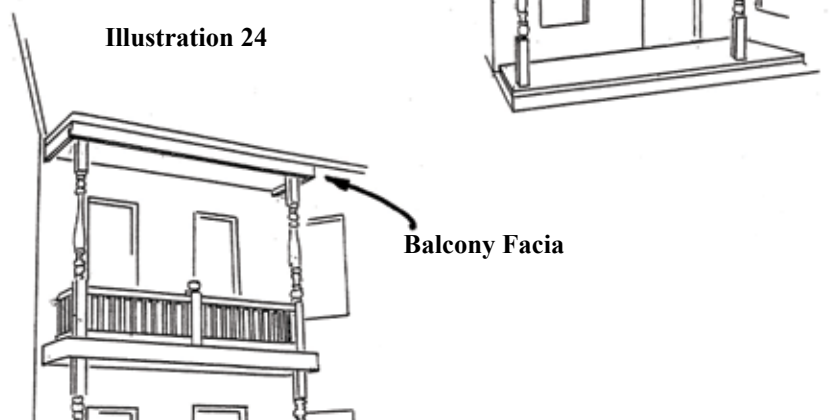
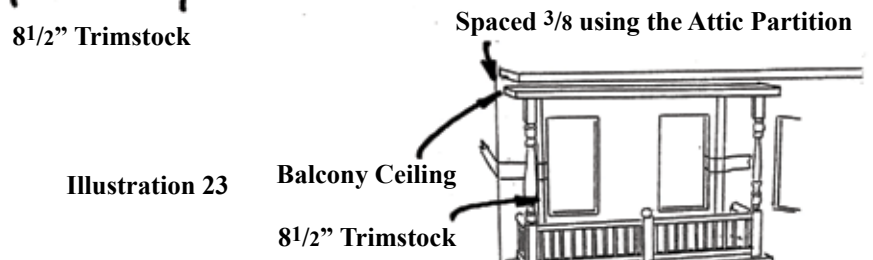
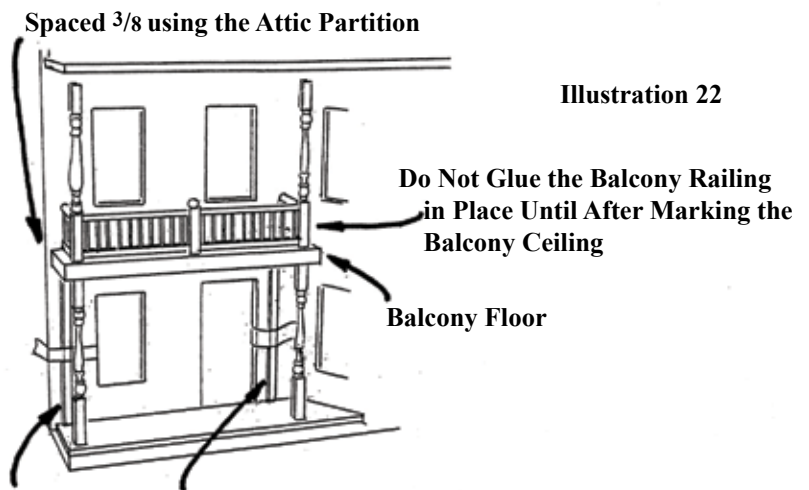
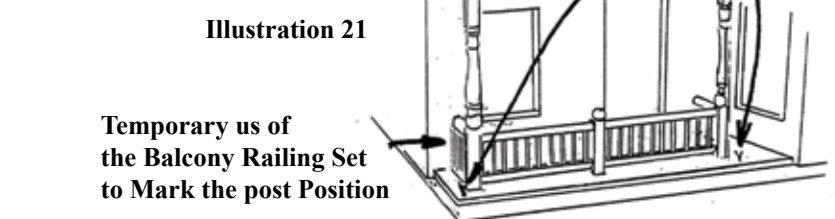
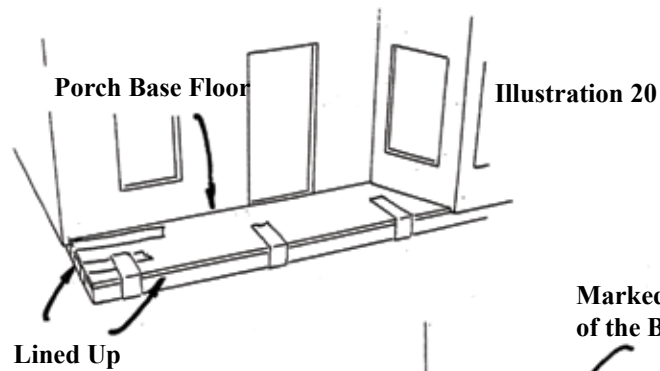

**Roof Assembly**

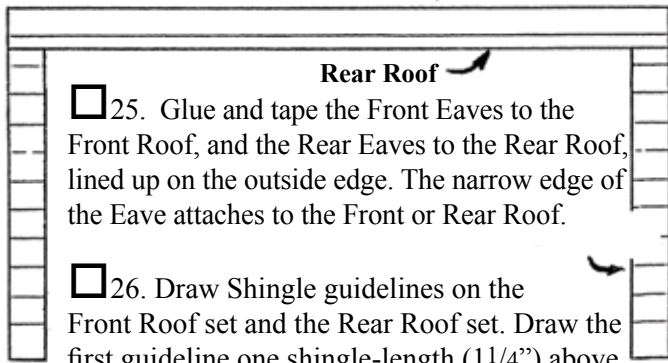

(a guideline measure is on the edge of this page).

27. Tape together the Front and Rear Roofs at the peak and test them on the house, centered side-to-side (11/16"). Trace the location of the Sides on the bottom of the roofs.

Paint the Roofs to the tracing.

28. Glue and tape the Front and Rear Roofs together and to the house, centered side-to-side.

29. Glue and tape the (painted) Gable Front to the Top Floor, lined up on the right edge.

**Note:** For the show models that we assemble at Real Good Toys, we set the Gable Front 3/4" back from the front edge of the Top Floor, but you should decide where you like it best.. all that's necessary is that it is lined up at the right edge.

Tape the Attic Partition to the Gable Front to hold it straight up-and-down as the glue dries (use the Attic Partition as shown so you can proceed with #30).

30. Tape together the Left and Right Gable Roofs at the peak. Test fit the Gable Roofs on the house, and trace the Gable Front's location on the bottom of the roofs. Paint to the tracing.

31. Glue and tape the Gable Roofs together and to the house. Adjust the fit inside the attic. Use lots of tape, stretching it over the roof, down the sides, through the windows, and inside the attic.

**Illustration 25 & 26**

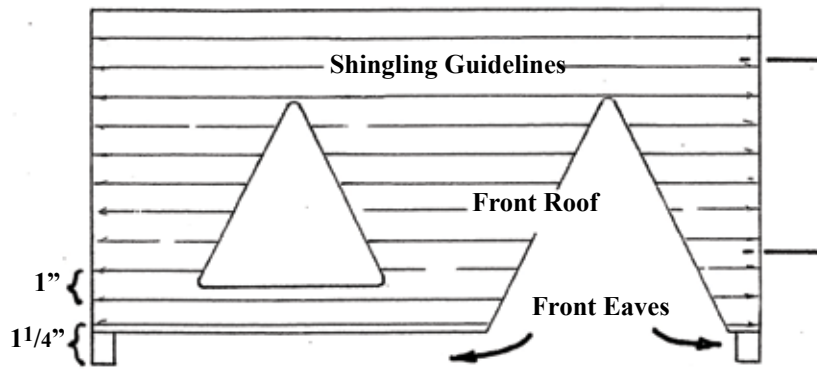

**Illustration 27 & 28**

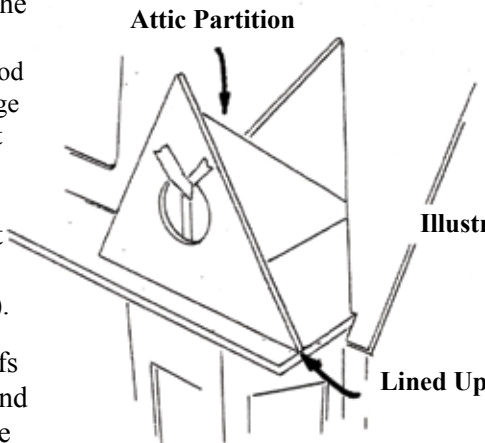
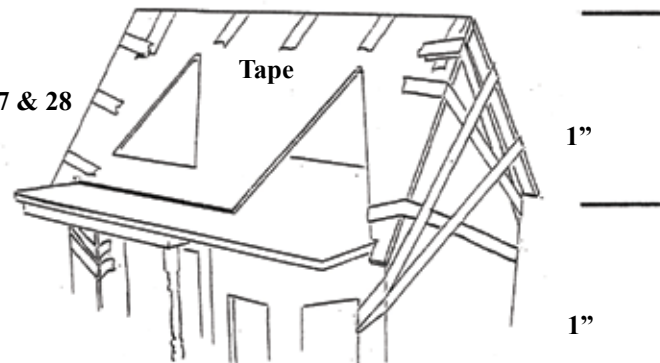

**Illustration 29**

**Note: this layout diagram may not print at exactly one inch. If it isn't, use a ruler instead. 1"**

**Illustration 31**

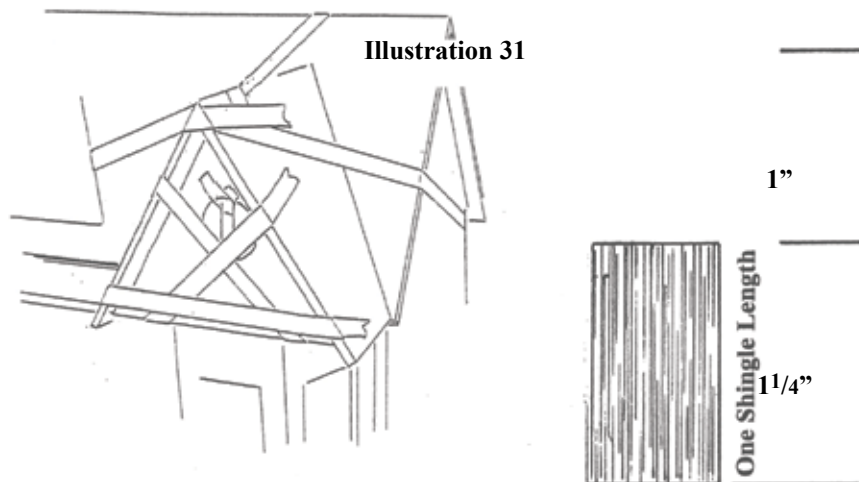

**Illustration 30**

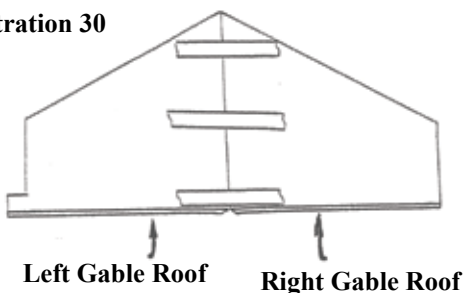

32. Glue the Porch Roof Triangles to the Top Floor and Front Roof, straight front-to-back. Set the left triangle in about 1/4" from the Left edge.

33. Test, then glue, tape, and weight the Porch Roof to the Triangles and Roofs. Let the glue dry.

34. Draw shingle guidelines on the Porch Roof using the same spacing as the Front Roof.

35. Tape together the Dormer Roofs at the peak.. Fit the Dormer Front into the roofs so that the back edge of the Dormer Front exactly lines up with the back corner of the Dormer Roofs, and the front eave is even. Trace the Dormer Front's location on the Dormer Roofs, and paint to the tracing.

36. Glue and tape the Dormer Roofs together and to the Dormer Front.

37. Glue and tape the Dormer set to the house, centered on the dormer cutout. Tape on the inside.

38. Draw shingle guidelines on the Gable and Dormer Roofs, extending the guidelines from the Front Roof. Measure down from the peak to make the guidelines straight.

Step 32

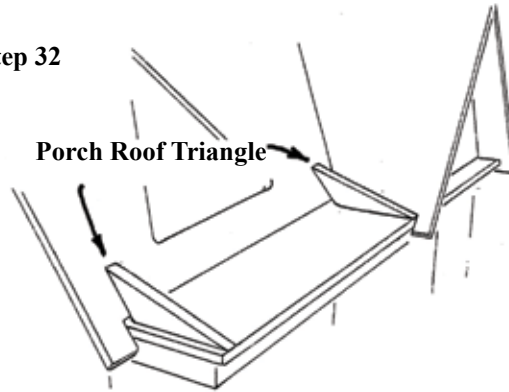

Step 33

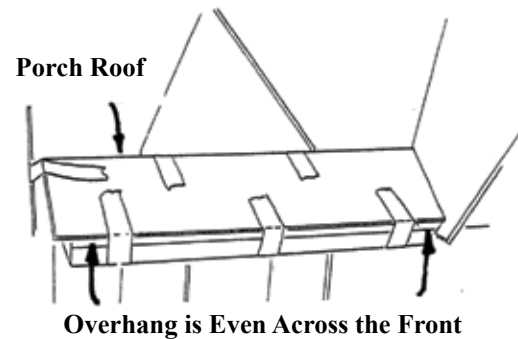

Lines Up at the Corner

Step 36

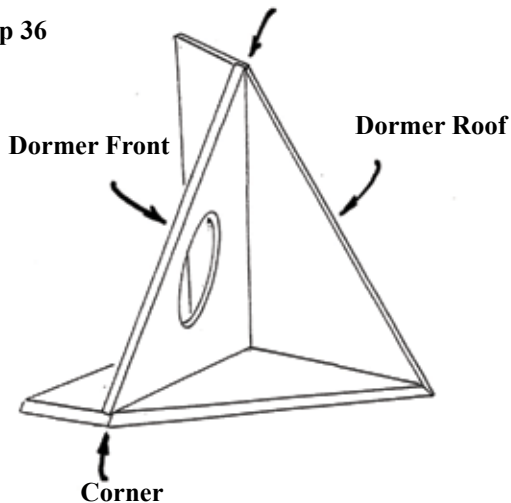

Step 38

Extend the Guidelines

Step 34

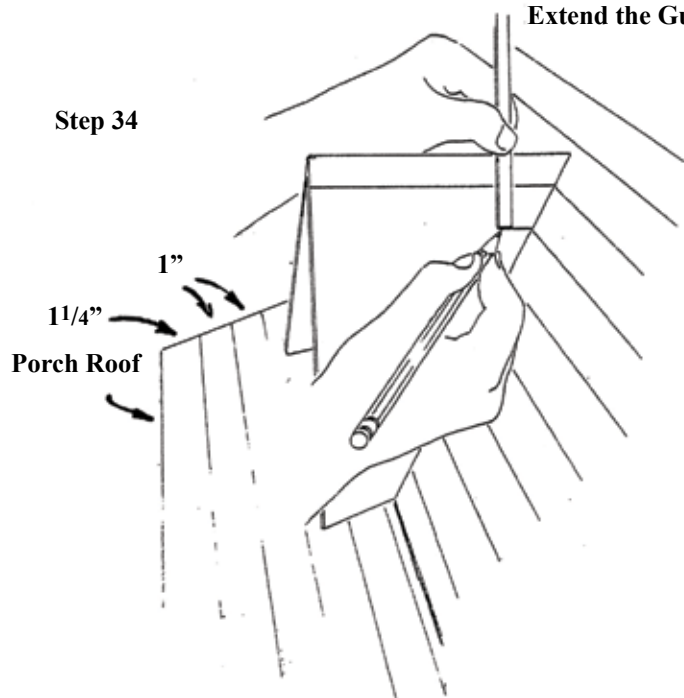



**Shingle The Roof:**

Glue: Use a thick panel adhesive such as Liquid Nails®Macco available in a caulking gun tube at building supply stores. Trim just a little of the end of the tube for a tiny hole, to give a thin bead of glue. Always use good ventilation with solvent based adhesives.

39. Apply a thin line of adhesive 1/8" below the lowest guideline. Press the top edge of a Shingle into the line of glue, squeezing out the excess. Hold the first Shingle steady and press another shingle into the adhesive, tight to the first. Hold the next Shingle and press in another... etc. all the way across the roof, cutting the last shingle to fit. Cut shingles with scissors or a fine toothed saw such as the X-acto® razor saw to fit around every shape or obstacle. Finish each row before starting the next row.

40. Continue up the roof one row at a time. Start every other row with a half Shingle so that the seam between Shingles is staggered back and forth as you go up the roof.

Cut half shingles for the Front Roof's 1<sup>st</sup> row above the Porch Roof.

Cut angled Shingles for the valleys before attaching them.

**"Boston Lap":** Lay horizontal shingles on the peak (front and back pairs glued on at the same time), starting at the ends and working to the center.

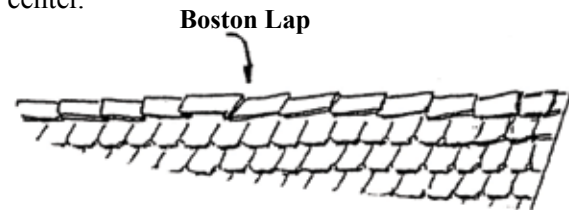

There is a Shingling section in the [www.realgoodtoys.com](http://www.realgoodtoys.com) website

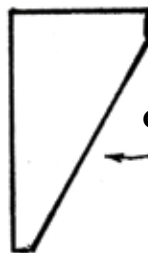
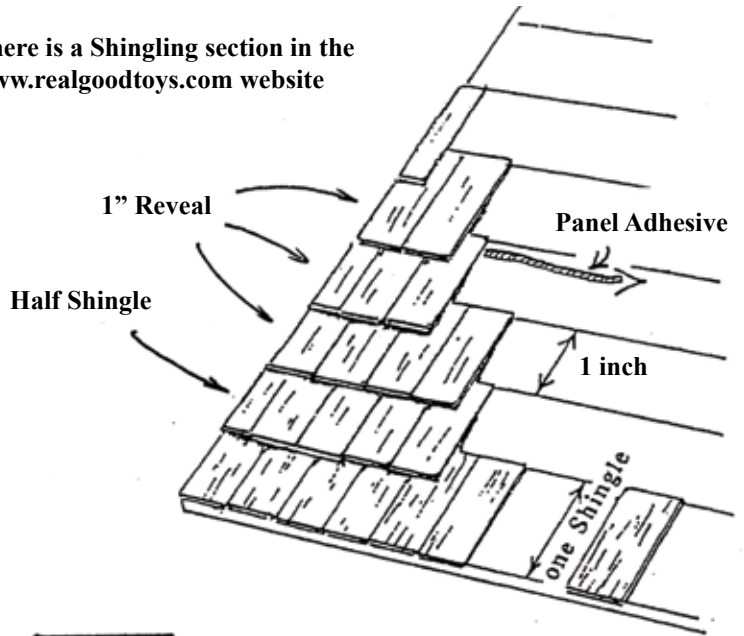

Gable or Dormer Roof at the Valley

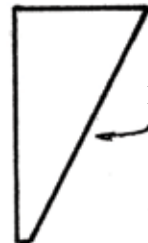

Front Roof at the Valley

Short Shingle



Cut shingles wherever necessary to make a row come out even on the bottom edge.



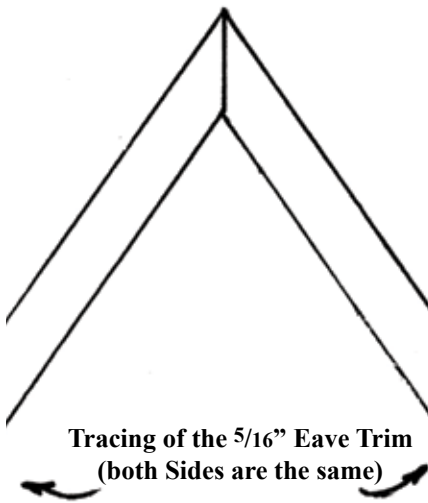

**Finish the Outside**

Plan your outside trim. The material supplied is more than enough to trim the house the way we do for our show models (Steps 41 – 44), but this architectural style welcomes fanciful and individualized ornamentation. Trim material like that in the kit, and many more styles as well is available at your miniature store. Whatever your trim design, plan all your cuts ahead of time. Use the drawings for the basic layout, but fine-tune each piece in place on the house. The Attic Partition is a handy angle guide for cutting the Trim. Paint trim before attaching it.

- 41. Mark, cut, and attach the 5/16 eave trim.
- 42 Mark and cut the 3/4 side banding, making adjustments as necessary for a good fit.
- 43. Hold the 1/2 Trimstock in place, then mark, cut, and attach.
- 44. Cut the 5/16 Porch side banding from 5/16 x 8 1/2" Trim. Attach the Porch side banding, then mark, cut, and attach the Porch front banding. Mark, cut, and attach the 3/32" Porch Banding.
- 45. Install the Windows and Door.

**Note:** Two extra pieces of 3/32" Trimstock are supplied so you can add an additional layer of eave trim on top of the 5/16" Trim for added detail on both sides.

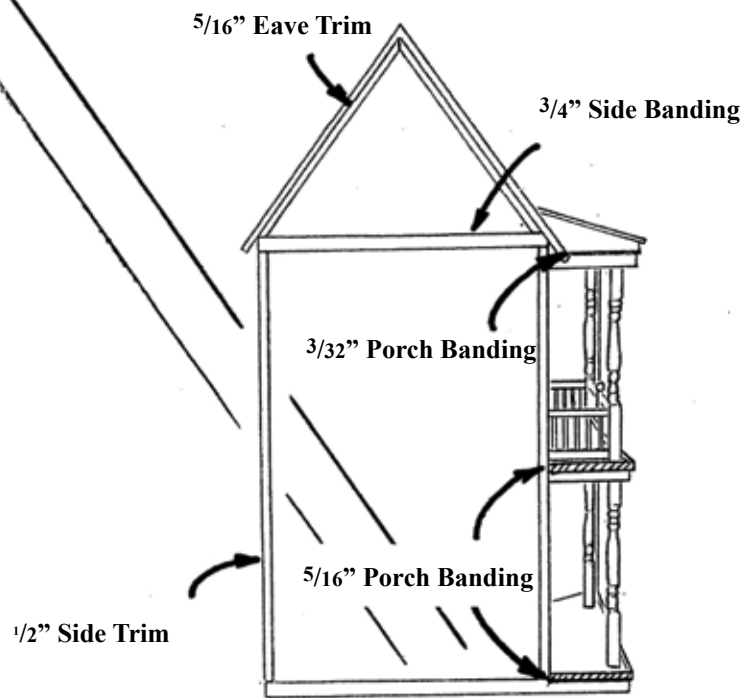
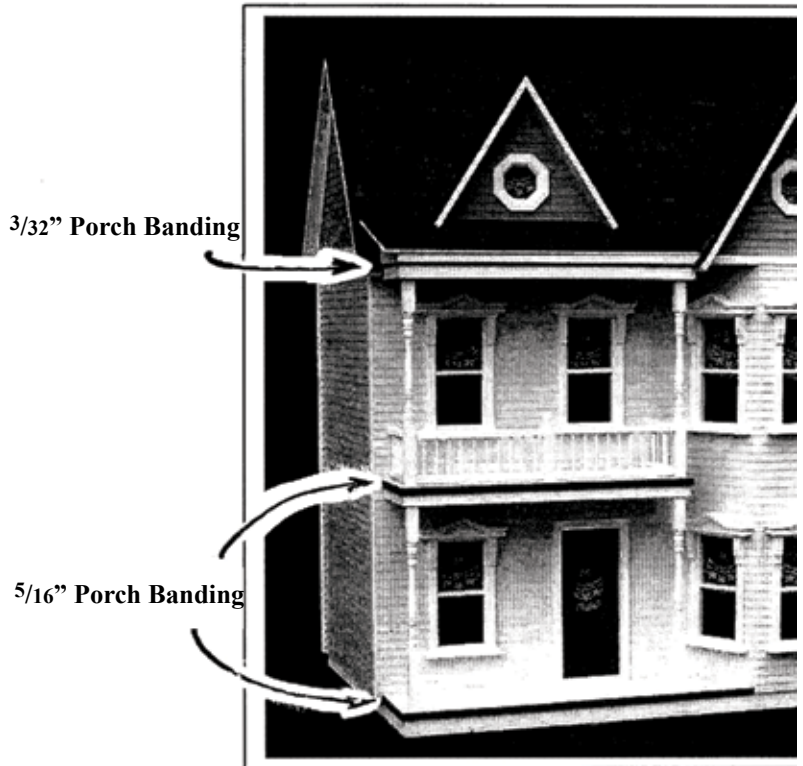

Shaped end of the 3/4" Banding  
(the Other End is Square)

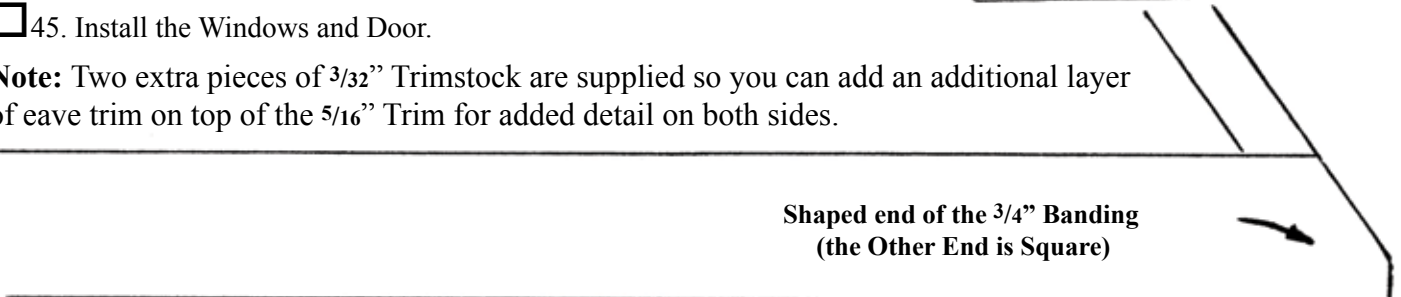

***Finish the Inside...***

***Plan Ahead for the materials you will need***

Our pro finishes the interior of a few houses each year. Here's the order that he follows for tackling the interior finishing:

- Electrical wiring (**tape** style)
- Dividers and Attic Partition
- Wallpaper ("Yes" brand paste)
- Interior Window and Door Trim
- Stairs
- Carpeting
- Baseboard and Crown Molding

46. Install the 1<sup>st</sup> floor Divider without glue, lined up with the stair hole. Adjust the fit using the other Divider and the Attic Partition to make it straight up-and-down, and square front-to-back. Lightly mark the position. Repeat the locating steps for the 2<sup>nd</sup> floor Divider, then for the Attic Partition. Glue in the Dividers and Attic Partition.

47. Glue and tape together the window and door trim. Let the glue dry, then glue it in place on the window and door frames

48. Glue the Bottom and Top Stair Blocks together. Without glue, test the Stair assembly in the stair hole. The stairs are tight to the Divider and the top tread is flush with the floor.

Glue the stairs in place. Let the glue dry.

49. Line up the Stringers with the pattern, and mark the cut with a pencil. Cut the Stringers with a fine-toothed saw. Glue the Stringers to the side of the Stairs.

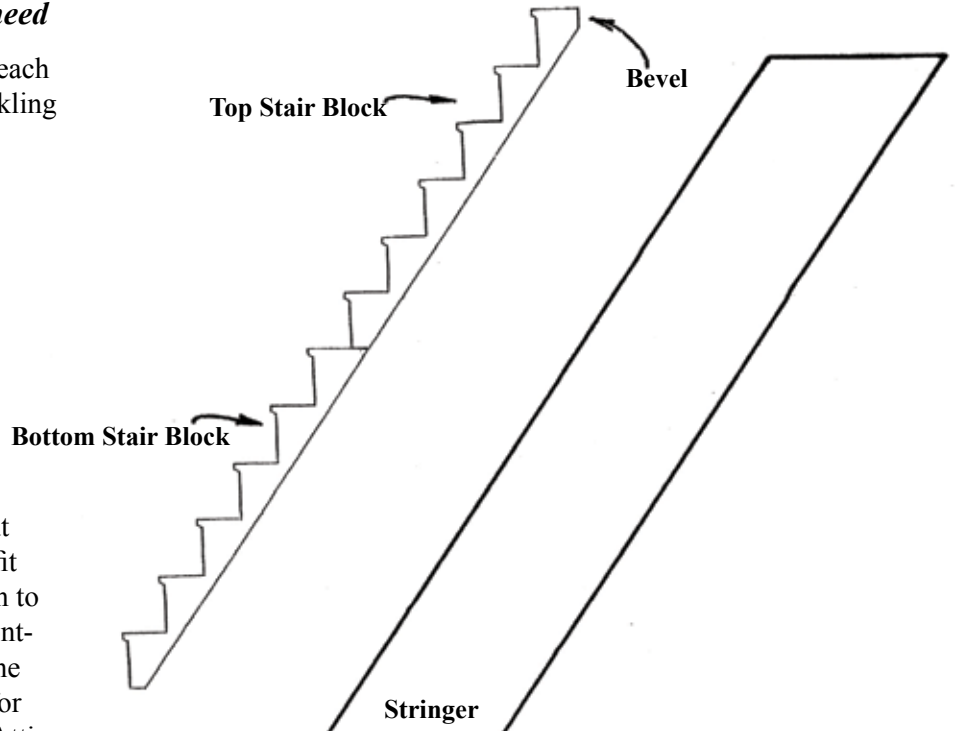

**You're done with the Dollhouse part of your Project. Enjoy the Rest!**

Stringer  
Cut

