

Congratulations on your choice of a Real Good Toys product. Your kit has been precision made with meticulous care by our craftspeople using carefully selected materials. This Dollhouse will last for years, even generations, if heirloom care and attention is given during assembly. Take your time and read the instructions completely. If you have questions, ask the experts at your local Dollhouse Store or at [info@realgoodtoys.com](mailto:info@realgoodtoys.com)

**Before you begin** - You have already opened the box and see all the parts organized in boxes and bundles. For the moment, keep them that way. There are important things to do before you open your glue bottle.

**Choose your color scheme.** Look at houses in your community, models in your local Dollhouse shop or at our website: [realgoodtoys.com](http://realgoodtoys.com); look at plan books from a paint store or architectural books at your library (a favorite is: Painted Ladies by Michael Larsen and Elizabeth Pomada). You will be painting some of the parts right away so get the paint now. Choose high-quality semi-gloss latex enamel paints for ease of use and durability.

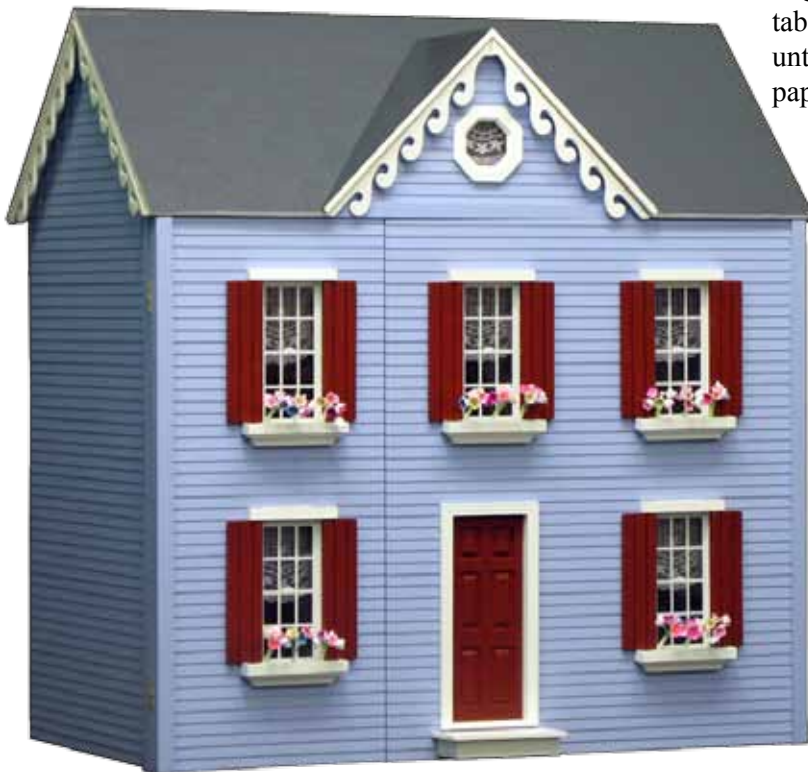

**Measure and identify the parts:** The kit is packed in groupings that protect the parts, and that is how the Parts List is organized. As you measure and identify the parts, label them with sticky notes using the names from the parts list, and check them off the parts list so you know you have everything. Taking the time now to identify and organize the parts also makes them familiar so you will understand what the instructions intend as you read ahead.

- Plan ahead so you know where you are going
- Read ahead so you know how to get there
- Paint ahead so the parts are ready when you need them

**Prepare your space:** This dollhouse will spread out over a large area while it is being built. You will need a large flat tabletop for the house, several boxes to keep parts organized until they are needed, and several trays lined with waxed paper for holding small parts like windows and railings.

A snap-lid box will keep your tools and supplies handy between building sessions.



### Tools and Supplies:

Tape measure or ruler, Pencil, Sticky notes (like PostIt®)  
White glue (like Aleene's Tacky Glue®) for all construction  
Solvent-based Panel Cement (like Liquid Nails®) for shingles  
Masking tape, Utility knife or coarse file, yardstick  
Fine tooth saw (razor saw (like X-Acto®) or a hacksaw)  
Painting Supplies, Sandpaper (especially 320gr)  
Waxed paper, Rubber Bands#8 and #32

PostIt®, Aleene's®, Liquid Nails®, and X-Acto® are registered trademarks of their manufacturers and have no affiliation with Real Good Toys

**Options:** see your miniature dealer

- 2060 Windows with louvered shutters
- 1119 Oval Light Door
- 4017 Fancy Interior Stairs and Landing Railings
- Fishscale Cedar Shingles
- EL-66 Hole starter and electrification tool
- Stucco Grit: Texture paint additive
- Dye-1: Brown shingle dye
- Dye-3: Grey shingle dye
- SC: Copper flashing

This kit will accommodate 1" Scale furniture

Identify the parts and make sure you have everything before beginning construction.

Any correspondence with Real Good Toys must use parts' names and measurements from the parts list.

Parts List: (measurements are approximate, and are for identification purposes only)

Drawings are not all the same scale

- SMOOTH PLYWOOD WALLS ("W-465" Kits only):
- 1 6220 Right Front: (3/8) 177/16 x 147/8, Door & Windows
  - 1 6221 Left Front: (3/8) 177/16 x 71/2, Windows
  - 2 1054 Endwall: (1/4) ±2313/16 Peaked x 113/4
  - 1 6515 Gable Triangle: (1/4) 57/8 tall x 113/4 base triangle
  - 4 1519 Wall Liner: (1/8) 85/32 x 111/2
  - 2 6516 Attic Liner: (1/8) 57/8 x 113/4 Triangle, inlet
- MILLED MDF WALLS ("MM465" Kits only)
- 1 6210 Right Front: (3/8) 177/16 x 147/8, Door & Windows
  - 1 6211 Left Front: (3/8) 177/16 x 71/2, Windows
  - 2 1013 Sidewall: (1/4) 113/4 x 173/4
  - 1 6519 Gable Triangle: (1/4) 57/8 tall x 113/4 base triangle
  - 4 1520 Wall Liner: (1/8 MDF) 85/32 x 111/2
  - 2 6518 Attic Liner: (1/8) 57/8 x 113/4 Triangle, inlet
- All Kits
- 1 1053 Base Floor: (1/4) 223/32 x 113/4
  - 1 1085 Second Floor: (3/8) 223/32 x 113/4, Stair Hole
  - 1 1052 Third Floor: (3/8) 223/32 x 113/4
  - 1 6235 Back Wall: (3/8) 223/32 x 1731/32
  - 1 6511 Rear Roof: (1/4) 233/4 x 81/2
  - 1 6512 L Gable Roof: (1/4) 57/8 top x 83/8 tall triangle
  - 1 6513 R Gable Roof: (1/4) 53/4 top x 83/16 tall triangle
  - 1 6514 Front Roof: (1/4) 233/4 x 93/8
  - 2 1082A Divider Body: (3/8) 85/32 x 77/8
  - 2 1082B Divider Back: (3/8) 85/32 x 13/16
  - 2 1082C Divider DoorTop: (3/8) 111/16 x 31/16
  - 4 1568 Corner Fill: (1/8 x 1/4) 81/8
  - 1 1541 Front Step: (3/4) 13/4 x 4, lip
  - 1 465GB Gingerbread: (1/8) 111/4 x 715/16
  - 1 1067 Stair Base: (1/4) 21/4 x 99/16, Bev.
  - 11 1543 Stair Blocks: (3/4 x 5/8tri) 21/4

LONGS BUNDLE

- 1 6553 Ridgepole: (3/4 pine) 3/4 x 213/4
- 2 1510 Underframe: (1/2 x 1/2) 223/32
- 1 6551 Left Side's Hinge Strip: (1/2 x 3/4 grooved) 183/8, Mitered
- 1 6552 Right Side's Hinge Strip: (1/2 x 3/4 grooved) 183/8, Mitered
- 2 1567 Front's Hinge Strip: (1/2 x 1/2 grooved) 177/16,
- 2 6557B Front Backer Strip: (1/8 x 1/2) 177/16
- 1 6554 Rear Roof Hinge Strip: (3/8 x 3/4) 2127/32
- 1 6560 Front Roof Stiffener: (3/8 x 11/16 angled) 215/8
- 1 6556 Rear Roof, Top: (1/4) 1 x 233/4

SHORTS BUNDLE

- 2 1511 Underframe: (1/2 x 1/2) 10 3/4
- 1 1542 Stair Side Board: (1/8 x 11/8) 91/2, Mitered
- 6 1572 Glue Strip: (3/16 x 3/16) 6
- 1 6558 Gable Trim: (1/8 x 1/2) 113/4, Mitered
- 2 6559 Inner Eave: (1/4 x 1/2) 813/16, EndBevel<sup>1</sup>

5 WX WINDOW PACKS, Each Contains:

- 1 Window Pane: 6 over 6
- 2 Shutters: (3/16 x 13/16) 41/2
- 2 Shutter Spacers: (3/16 x 3/16) 41/2
- 2 Sill/Lintel: (1/4 x 3/8) 3
- 2 Interior Side Trim: Mitered
- 2 Interior Top & Bottom Trim: Mitered

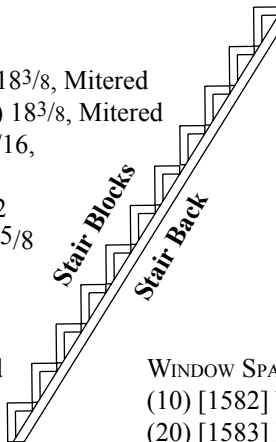
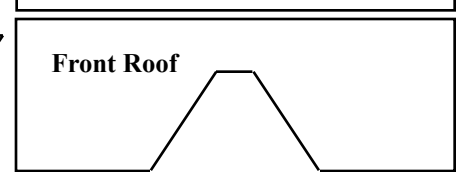
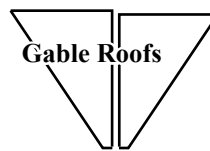
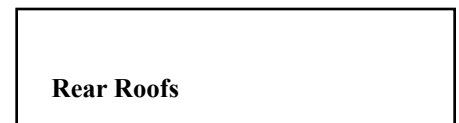
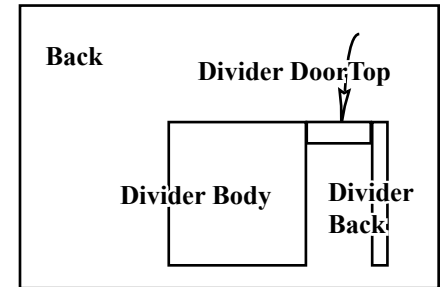
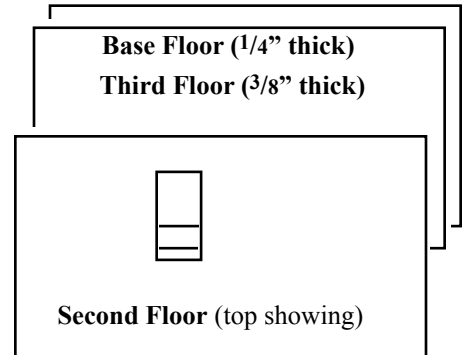
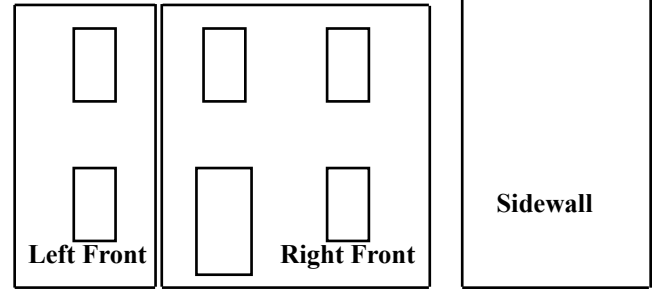
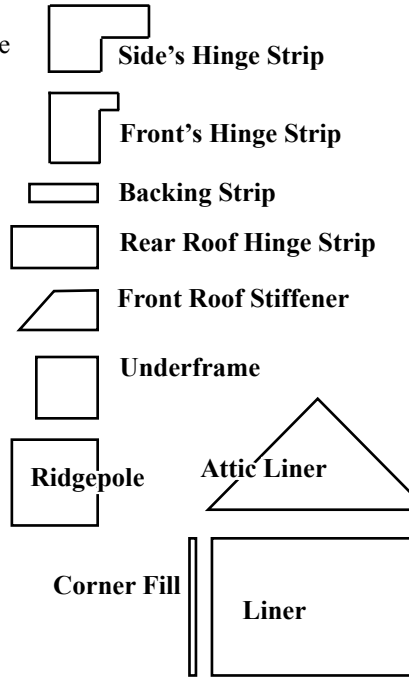
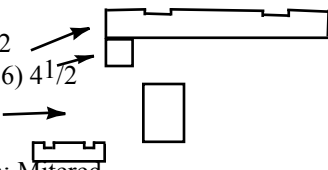

WINDOW SPACER PACK:

- (10) [1582] Vertical Spacers: (1/8 x 1/8) 41/2
- (20) [1583] Horizontal Spacers: (1/8 x 1/8) 27/16

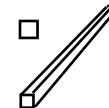

DOOR BOX

- (1) [U1015] Door
- (2) [U2018] Octagon Window
- (1) [U1018] Landing sets: 23/4 & 37/8

Landings



HARDWARE PACK

- (6) Hinges
- (4) 3/8 FH Screws (for Front Roof)
- (20) 1/2 FH Screws
- (1) 5/8 Brads Pack
- (1) Magnetic Catch & Strike Plate w/ screws

**Assembly Notes:**

A large, clutter-free, well-lighted work area is helpful during assembly, but a flat work surface is essential.

**Read the instructions** carefully; look at each of the illustrations. **!With the parts in your hands!**, think the assembly through before you proceed.

Test fit each time you are ready to glue a piece in place...then you'll know you have it right.

If more tape or a helper is needed, it's good to know that before the parts have glue on them.

Don't be stingy with glue or tape; use generous amounts. Always wipe off excess glue immediately.

Keep one damp rag and one dry rag handy all the time.

**Have weights available** for holding things tight as glue joints dry (stacks of books, gallons of pure Vermont Maple Syrup - anything heavy). Make sure everything is straight and flat as glue dries... That's the shape that will be permanent.

**Glue the body of your dollhouse together** with white, water clean-up glue that dries clear such as Aleene's Tacky Glue®.

**If you Shingle**, use glue that doesn't have any water in it! If the glue says "water clean-up", it will curl wooden shingles. Look carefully at the glue you intend to use to be sure it is solvent-based (with warnings about flammability), or use hot-melt glue (and watch out for the burns).

**If you Wallpaper**, use methylcellulose paste or Yes® craft paste (for bookbinding or collage).

Brush paste on the wallpaper, then the wall, and finally smooth the wallpaper into position.

**When glue is drying**, skip ahead to upcoming assembly steps "⇨" and prepare the parts that will be used.

**Before you begin**, read the "Finish the Inside" section on the last page. Some finishing (like staining the floors) is easier to do before assembly. Plan ahead!

**OnLine Support:** There are tips, techniques, and extra help with your dollhouse project at: [www.dhbuilder.com](http://www.dhbuilder.com)

**Getting Started:** Do these things before the house assembly

**Square the corners** of the window, door, and stair holes with a utility knife - each cutout has a rounded corner left over from the tool that made it.

Make two cuts in each corner from the outside (one from each direction), then cut from each direction on the inside to cut away the rounding in the corner so the window, door, or stairs will fit.

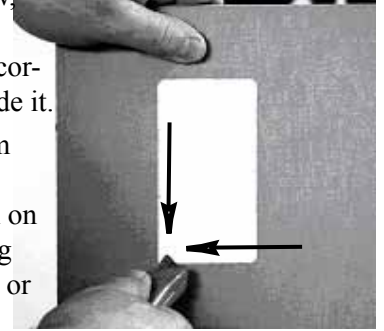

**Cleaning and Sanding:** Clean the parts thoroughly before painting; do the sanding (320 grit) after the first coat of paint.

**Painting:** The order of assembly and painting is a back-and-forth process of test-assembly, marking, painting, and final assembly. There are three things to keep in mind as you do this:

1. **Glue doesn't stick to paint.** It does, however, stick to a part that has been first-coated and sanded. For this reason, parts that will be the same color can be glued together after one coat and sanding, but before the second coat of paint is applied.
2. **The quality of your paint job depends on sanding** after the first coat, and sanding is easiest and best while the parts are un-assembled. (Often this means *first-coat, sand, assemble*)
3. **Where two colors of paint will be next to each other**, the neatest result will be achieved if the parts are marked and painted to just cover the mark, leaving the rest of the joint un-painted. That way, when they are glued together, the glue joint will have wood for strength, and the line between colors will be perfect (impossible with masking for painting)



... also available:  
465SS: Clapboard Siding set for "SP" kits

This kit comes in two versions, with either Smooth Plywood (SP) or Milled MDF (MM) used for the exterior walls. These instructions are used in both kits, and special notes that guide builders of one version or the other are throughout the pages.

**SP kit builders:** Plan ahead for the exterior finishing you will use. Paint or stucco does not need any special steps, but I apply clapboard (option #465SS) or brick after attaching the Roof, and before attaching the Porch or windows. Shingled siding, however, should be done after the porch is attached. Other treatments will have their own considerations, and they all need planning.

**Pre- Assembly**

- 1. Glue and tape together the Base Underframes.

The Base Floor is attached to the Underframes which will aim down. Inspect and choose the best side of the Base Floor to aim "up".

- 2. Glue and tape the Base Underframes to the Base Floor; line up the Underframes carefully with the edges of the floor.

Turn the Base over and weight it; let the glue dry. See "When glue is drying" on page 3

- 3. Glue, tape, and weight a Side's Hinge Strip onto each Sidewall. The lip of the Hinge Strip goes on the *outside* of the Sidewall and the angled top of the Hinge Strip lines up with the angled Sidewall top.

Make sure you have a left and a right Sidewall/Hinge Strip set by starting this operation with the walls face-up and side-by-side so you can see the orientation, and turning them over after gluing on the Hinge Strip so you can weight them while the glue dries.

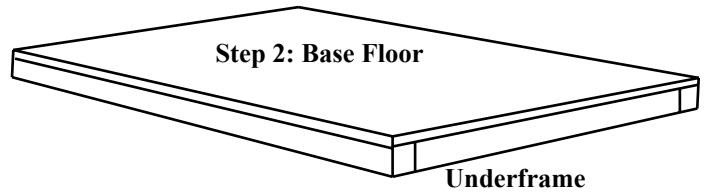
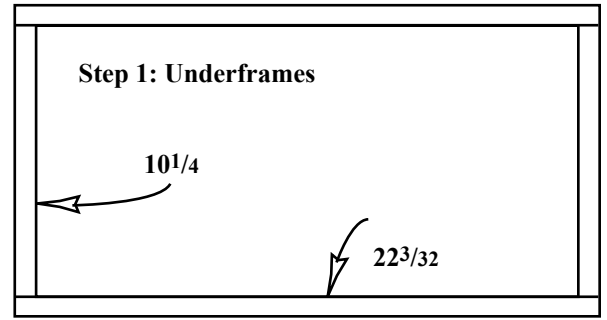

"MM" Clapboard Profile

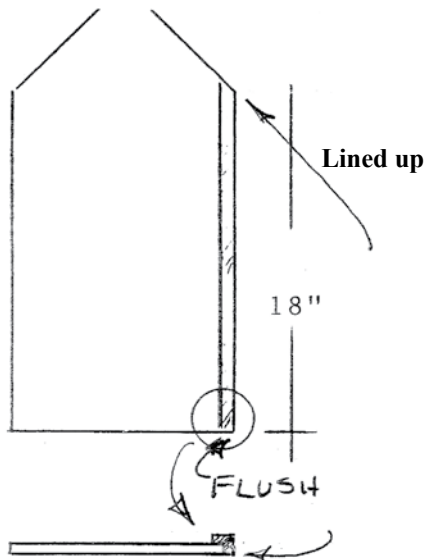

**Step 3**

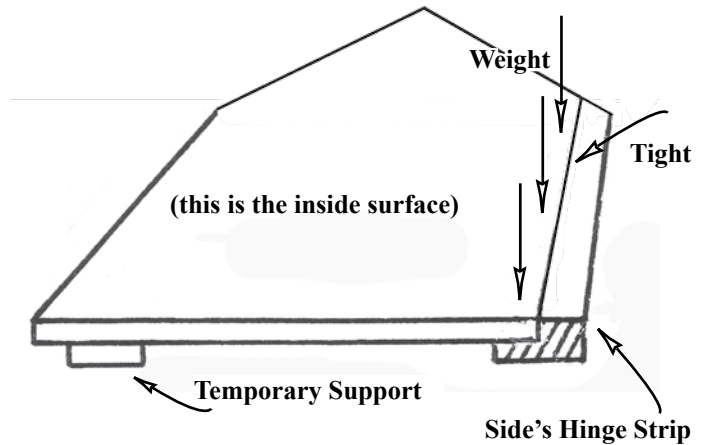

4. Set up the Fronts in their 'normal' orientation. The wider edge-to-window space is the bottom of the Left Front. Glue, tape, and weight 'Front's Hinge Strips' to the outside edges of the Fronts. Let the glue set.

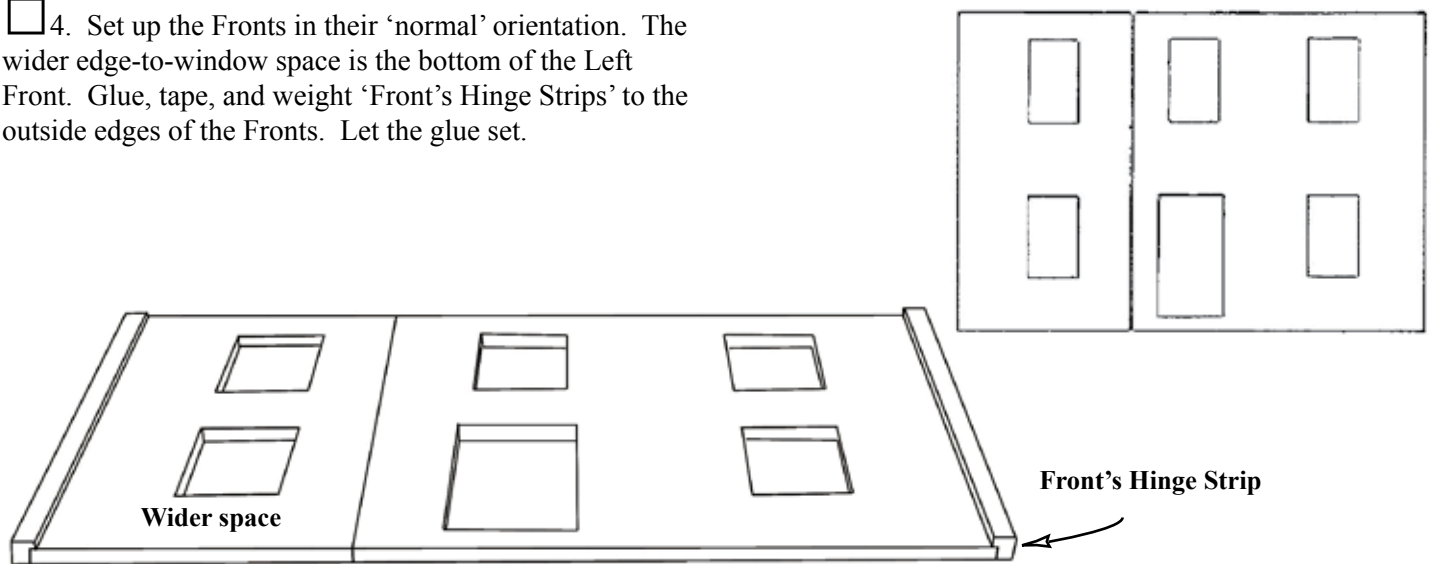

5. After the glue has set on the Front's Hinge Strips, turn the Fronts over; glue and weight Backing Strips to the inside surface of the Fronts, lined up with the edges. Let the glue set.

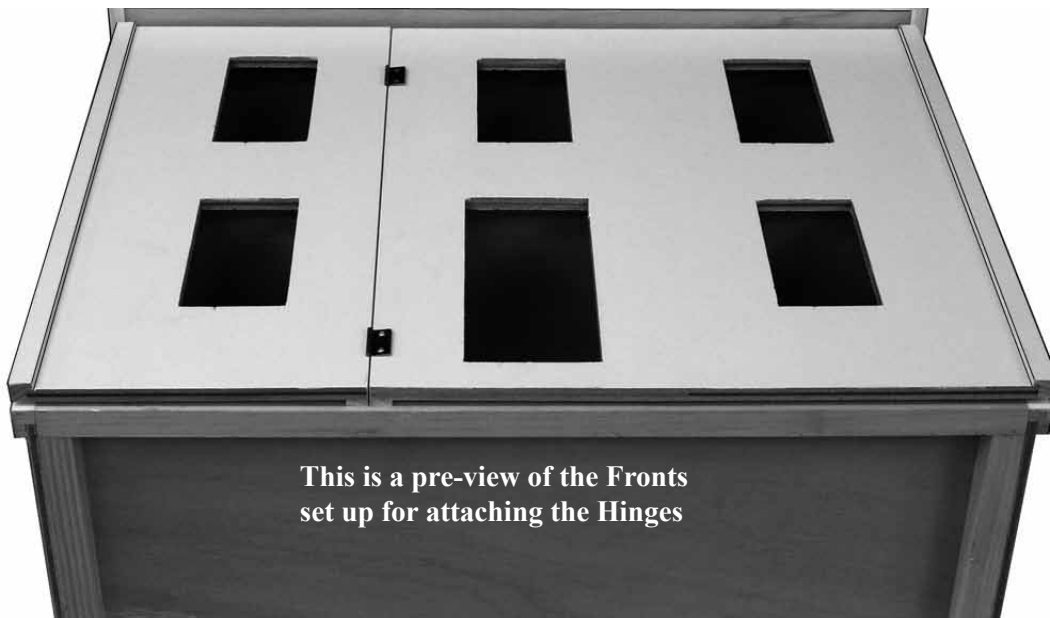
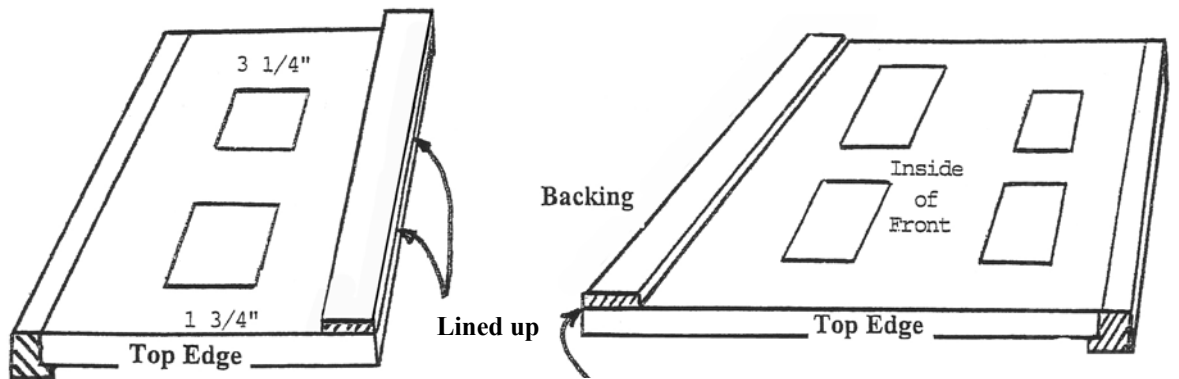

This is a pre-view of the Fronts set up for attaching the Hinges

**Assemble the Stairs:**

6. Test the Stair Blocks on the Stair Base to see how they fit; the narrow leg of the “L” is the top. Spread three lines of glue the length of the Stair Base.

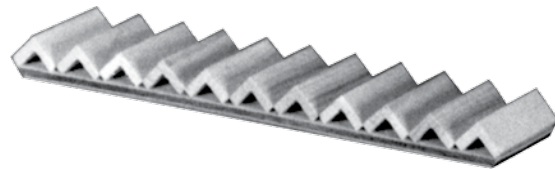

7. Glue the Steps to the Stair Base lined up to make the ends smooth at the top and bottom.

Before the glue dries, make sure all of the steps are aimed the same direction, lined up on the ends, and are spaced evenly.

Let the glue dry.

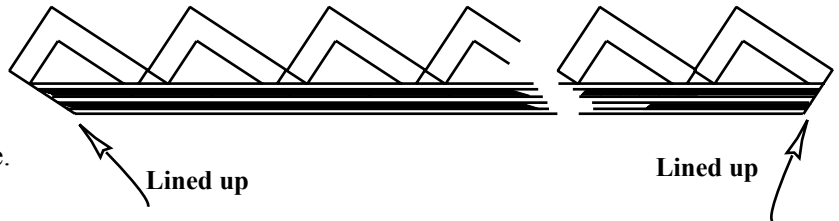

8. Glue together the Landings to make a right angle.

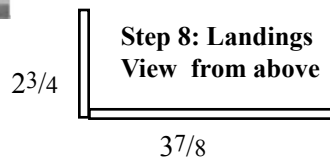
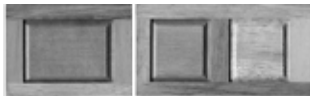

9. Glue “Glue Strips” to the back of each set of Gingerbread “Breakers”, lined up at the top edge.

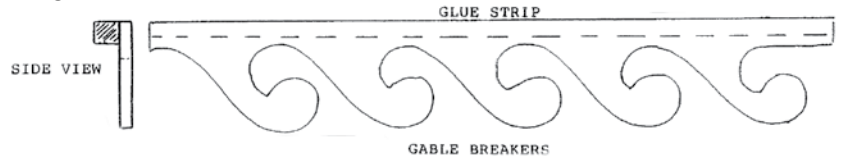
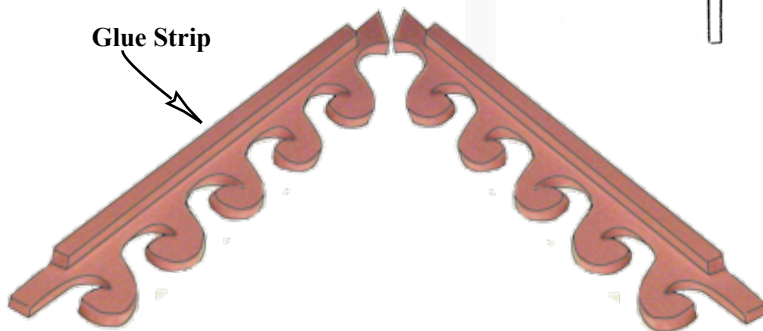

10. Glue the Front Step to the Front, centered under the door cutout and lined up at the bottom edge. Use a Divider if necessary to hold it square with the Front as the glue dries. When dry, turn the panel over and screw or nail the Front to the Step.

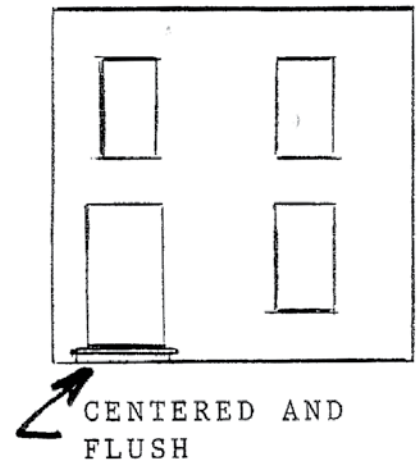

**Windows & Door:** ↻Paint the parts ahead of time.

SP builders: If you intend to install clapboard siding on your house, use the Oversized Shutter Spacers supplied in the clapboard kit.

11. Glue a Shutter Spacer, flush along the back edge of each Shutter, lined up on one edge and at the top and bottom.

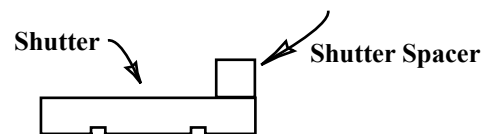

**Housebody:**

Now is a great time for an extra pair of hands.

12. Select the Base Floor assembly, an upper floor (this will be used for support only) and the Back panel. Glue and nail the Back to the Underframe, lined up at the bottom edges. Support the Back with the upper floor; *do not* get glue on, or nail into the upper floor.

13. Carefully, turn the housebody on its side. Spread glue on edges of the Back and Base. Glue, tape, and nail a Sidewall (the Side's Hinge Strip is in the front and outside) to the Back and the Base Underframe, lined up at the edges. Remember to check for a mis-aimed nail while the nail head is still sticking out. Repeat to attach the other Sidewall.

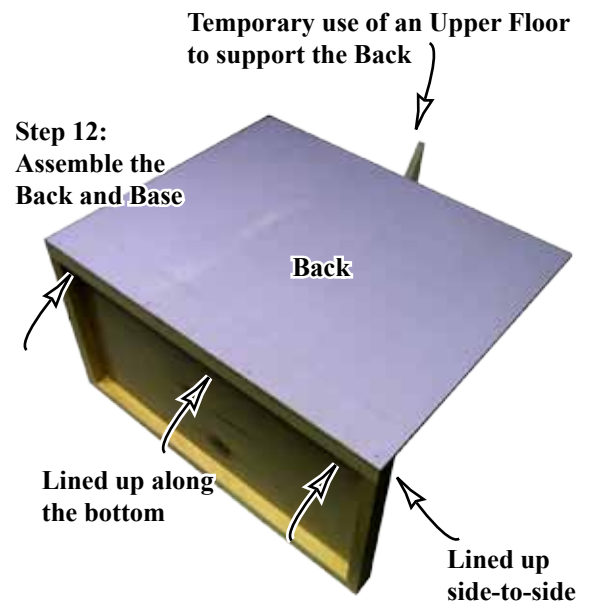

14. Stand the housebody upright. Glue and tape Liners and Corner Fills to Both Sidewalls, tight to the Base. Use the Second Floor and the Rear Roof Hinge Strip to gently give pressure to the back and middle of the Liner for a good glue joint. Let the glue dry.

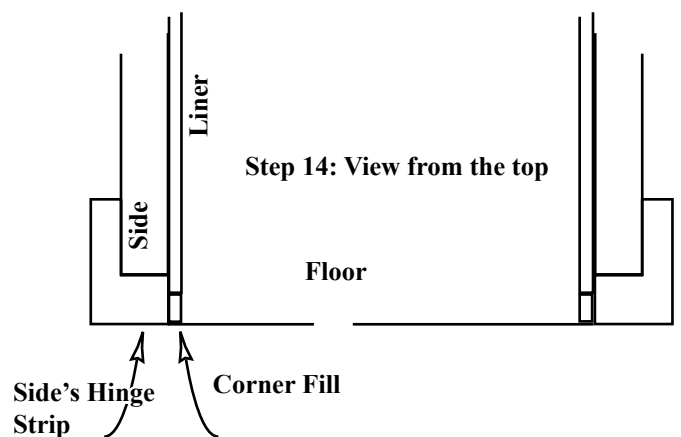
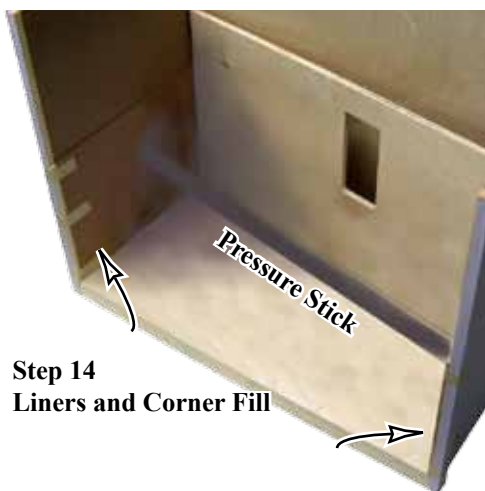

15. Spread glue on the ends and back edges of the Second Floor (the stairhole is closer to the back edge). Set the Second Floor on the Liners, and, without glue, on a Divider in the middle (to hold the floor flat side-to-side). Press down on the Second Floor and nail thru the Sides and Back into the floor. Measure from the bottom for exact nail placement and check for a crooked nail before the last hammer strike.

16. Glue and tape Liners and Corner Fills to the Sides, tight to the Second Floor. Use the Rear Roof Hinge Strip and other combinations of sticks and flat parts that add up to the right length for gentle pressure in the middle of the Liner for a good glue joint.

17. Glue, tape, and nail in the Top Floor, supported in the middle with Dividers; weight the floor as the glue dries. Let the glue dry.

Now is the best time to fill the nail holes and second-coat the painting on the housebody.

18. Glue, tape, and pressure the Attic Liners to the Sides.

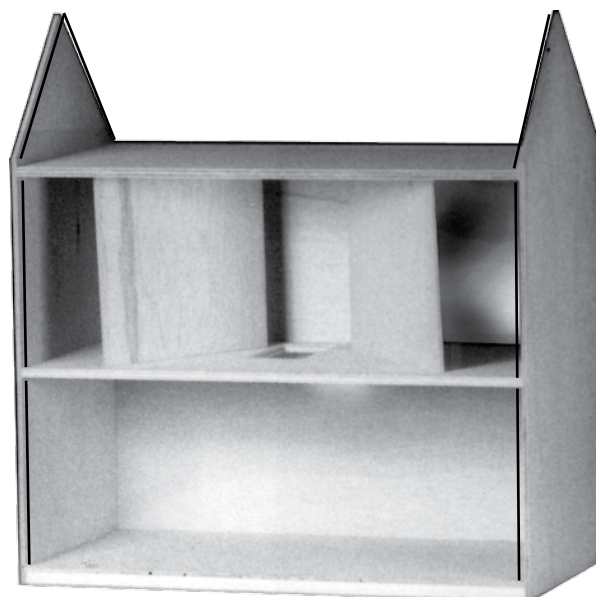
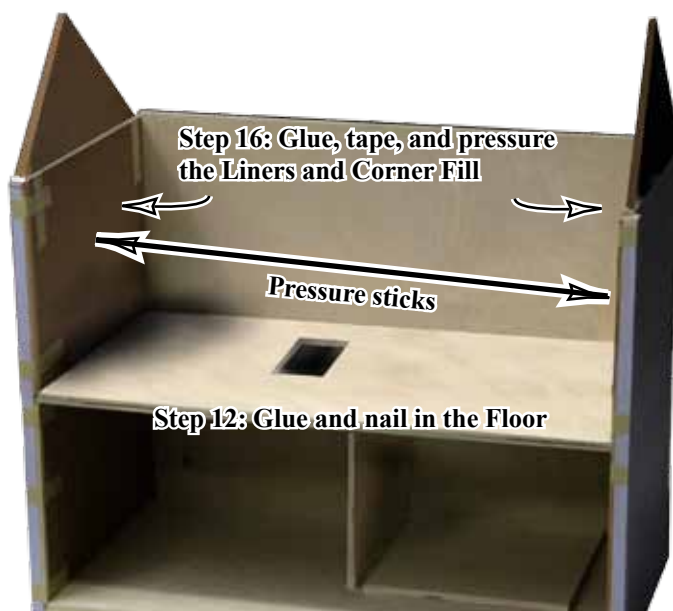
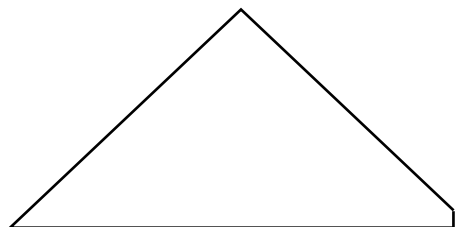



⇨ **Attach the Hinges**

Builder's Note: There are two ways the Fronts can be hinged

- 'Bi-fold' hinge setup hangs the Left Front from the Right Front so they open together (see page 1).
- 'Double' hinge setup hangs the fronts independently, one from each side (see page 3).

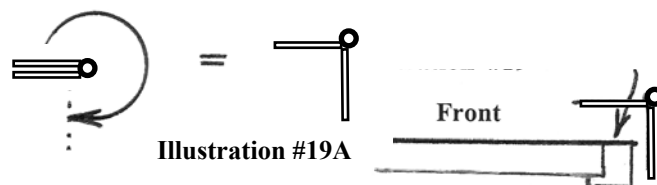

19. Lay the Fronts on the workbench with the inside surface up. Fold hinges back (Illustration #19A) and set them along the edges of the Fronts (or just the right edge of the Right Front if you have chosen the 'bi-fold' hinging option, Illustration #19B). Space the hinges ~2" from the top and bottom of the fronts.

Drive a nail centered in each hole part way thru the Hinge Strip, and pull it back out. Screw the Hinges to the Hinge Strips with 1/2" screws (the longer ones). 'Bi-fold' builders: Screw hinges to the Backers (Illustration 19B).

20. Put one or two long flaps of tape on each hinge that will screw to the Sides - more tape is better.

Fold the hinges to the "closed" position.

With the house on its back, set the Fronts on the house nearly touching the 3rd Floor and lined up on the Sides.

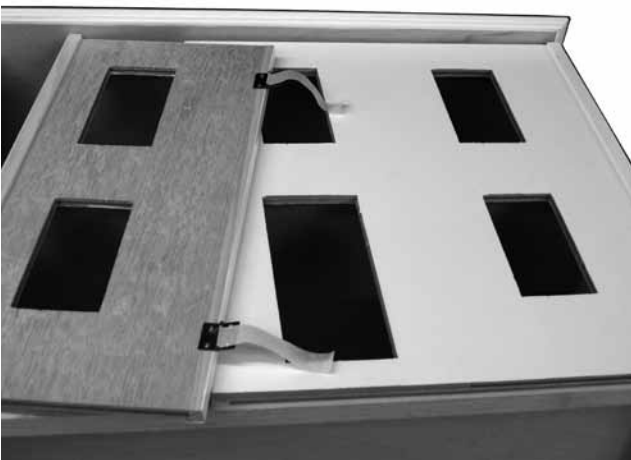
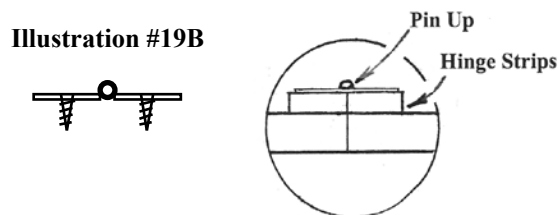
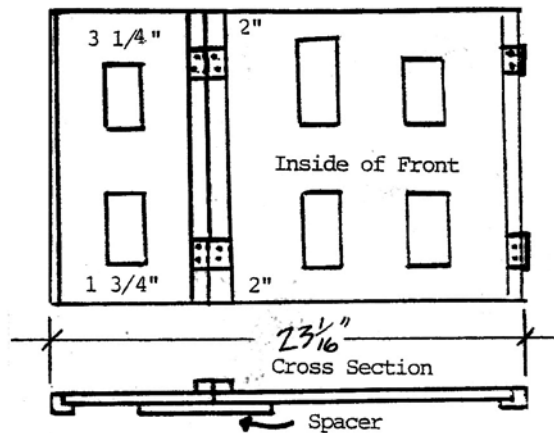

A helper will be useful for gently supporting a Front while you screw the hinges to the Sides.

21. Reach inside the house thru a window hole and firmly rub down the tape, sticking the hinges to the Sides. VERY GENTLY open one Front, drive starter holes for the screws, and screw the hinges to the Side's Hinge Strips using 1/2" screws. Remove the tape.

'Double' builders: space the Fronts from each other with the leaf of the hinges for the roof

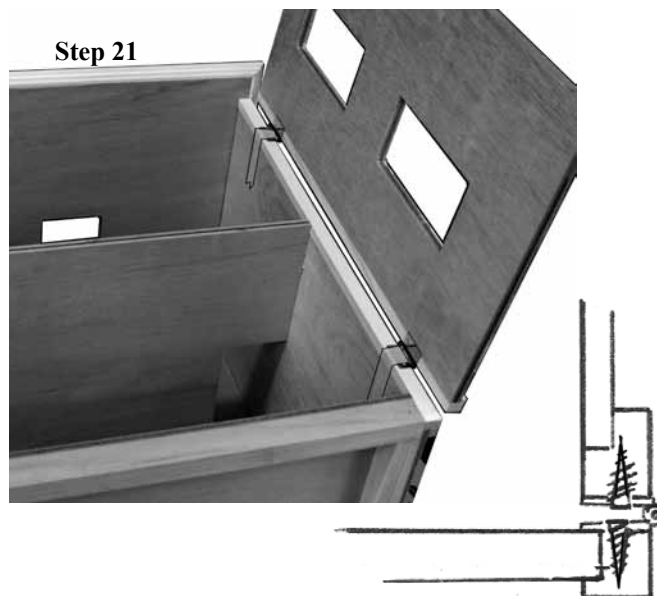

**Step 22 INSTALL ROOF HINGE STRIP ON REAR ROOF PANEL**

Glue the 22 1/16" long roof hinge strip to the underside of the large, rectangular rear roof panel. Center the hinge strip, end to end, and make it flush with the panel's edge. Clamp until dry.

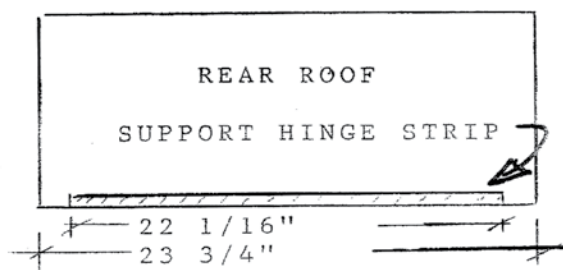

**Step 23 ATTACH THE RIDGEPOLE TO THE FRONT ROOF**

Glue the Ridgepole (3/4 x 3/4 x 21 7/8) to the underside of the Front Roof, flush at the top edge and centered side-to-side. Tape, weight, or clamp until dry.

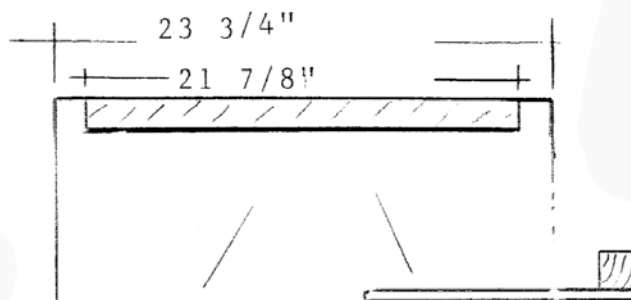

**Step 24 GLUE THE REAR ROOF-TOP TO THE FRONT ROOF**

Glue the Rear Roof -Top to the Front Roof and Ridgepole, flush on the front surface of the Front Roof (the Rear Roof -Top overlaps the Front Roof), and lined up on both ends.



**Step 25 INSTALLATION OF THE APEX BLOCK AND GABLE ROOFS**

"Mock up" (without glue) the gable roof configuration to establish the location of the apex block. Place the two longest gable roof panel edges against, and in line with, the cut out in the front roof panel. Adjust the panels so that the larger gable roof overlaps the smaller gable roof forming a 5 15/16" ridge line. The lower gable roof tips should coincide with, and "step out" 1/4" at, the bottom edge of the front panel. Once this alignment is achieved carefully remove each roof, in turn, and draw a line along the underside of the opposite, in place, roof. The intersection of these two line establishes the location of the apex block.

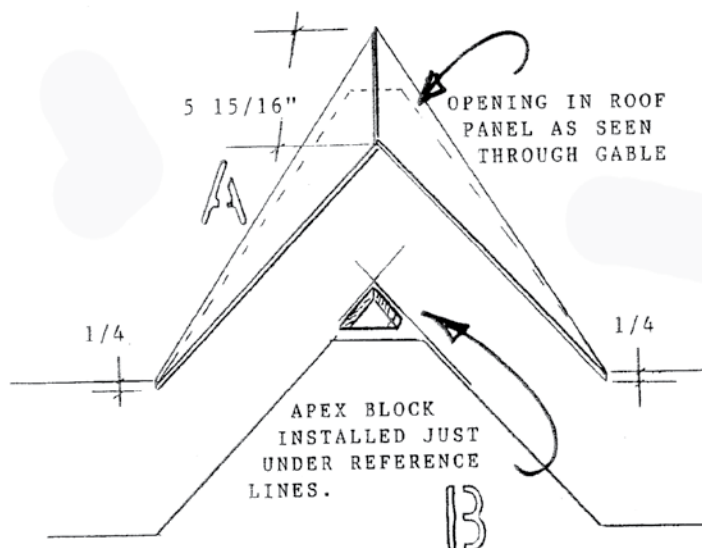

**Glue the Apex Block to the Roof**

**Step 26 ATTACH THE INNER EAVES**

Glue and tape the Inner Eaves to the top angled edge of the sides, flush on the inside and front edges.

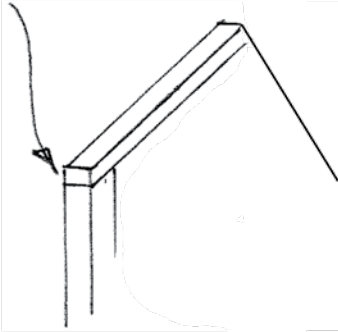
**Step 27 INSTALLATION OF THE REAR ROOF AND FRONT ROOF PANELS**

Place the front roof assembly on the gable ends WITHOUT GLUE. The ridgepole will fit between the tips of the two ends (with clearance) and the rear roof strip will wrap over the points of the ends. Apply glue to the rear sloping edges of the ends and install the rear roof panel with its hinge strip inside the house and "up" toward the rear roof strip. Use two of your window panes as spacers to establish a gap between the two roof assemblies. Carefully nail through the rear roof panel into the edges of the ends.

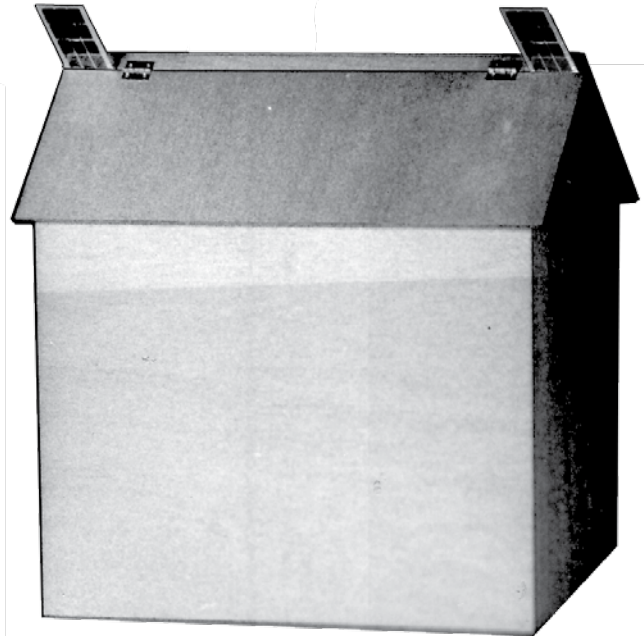

Install two roof hinges 3" in from the roofs' outer edges. Open the hinges and lay them flat with their hinge pins directly over the seam between the two panels. Drill pilot holes and install one screw in each hinge. Test the open/close action of the front roof panel. Make any necessary adjustment for proper function and then install the remaining screws.

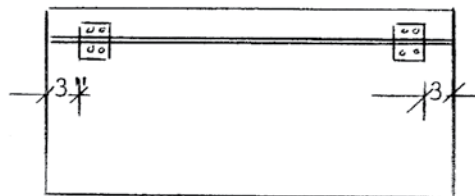

**Step 28**     **INSTALLATION OF THE HINGED FRONT**

Precise alignment and careful execution of the following procedure will simplify the installation of the front.

Lay the house on its back. You will need to put "blocks" under the back to avoid damaging the rear roof panel.

Place the front on the house so that it is **Just** below the lowest point of the (closed) roof front **and** centered on the end hinge strips. Make accurate marks on the hinge strip above and below each hinge. **ALSO** note how far each hinge pin protrudes beyond the outside edge of the hinge strip.

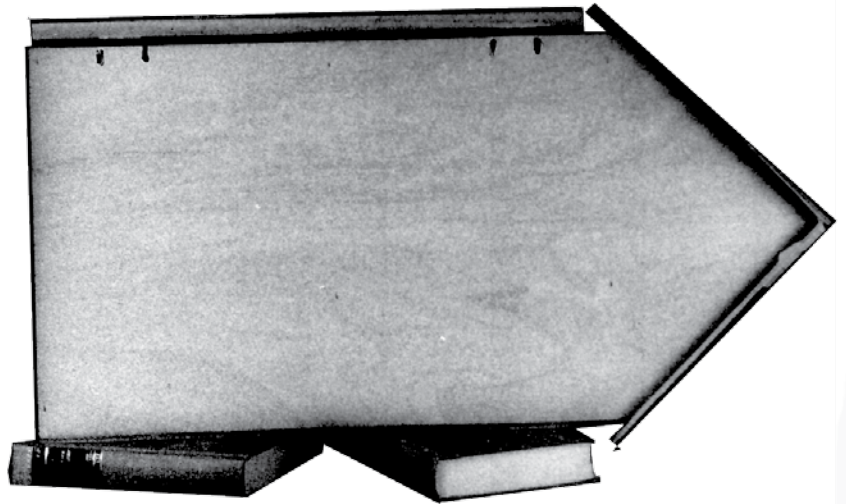

Lift the front off the house and remove one of the hinges. Using your reference lines, and your recollection of how far each pin protruded, re-position the hinges on the hinge strip. Mark the center of the top hinge holes and drill pilot holes.

Re-install the hinge on the front and stand the house upright. Install the front on the house using the top hinge holes only. **NOTE** - tighten screws enough so hinges do not rotate with the weight of the front panel. Gently operate the front. It should swing smoothly maintaining the desired alignment.

If the front needs adjustment move the appropriate hinge and insert a single screw in the bottom hinge hole. As before, drill a pilot hole so positioning remains accurate.

Once the front is properly aligned drill remaining pilot holes and install all remaining screws.

**Step 29**     **INSTALLATION OF THE GABLE TRIANGLE AND ROOF FRONT SUPPORT STRIP**

With the house in the upright position and the front closed, place the gable triangle (**WITHOUT GLUE**) under the gable roofs in the same vertical "plane" as the hinged front. Note the distance the gable triangle is inset from the front edges of the gable roofs at the gable triangle/hinged front seam. Insure this inset distance remains constant and draw a reference line along the undersides of both gable roof panels.



**Step 30**

Apply glue to the angled edges, and using your lines as a reference install the gable triangle. Use masking tape to clamp until glue dries.

Install the front roof support strip on the back of the roof front directly behind, and in contact with, the gable triangle. Apply glue to the beveled edge of the support strip, insure it is centered, left to right, and parallel with the lower front roof edge, and clamp.

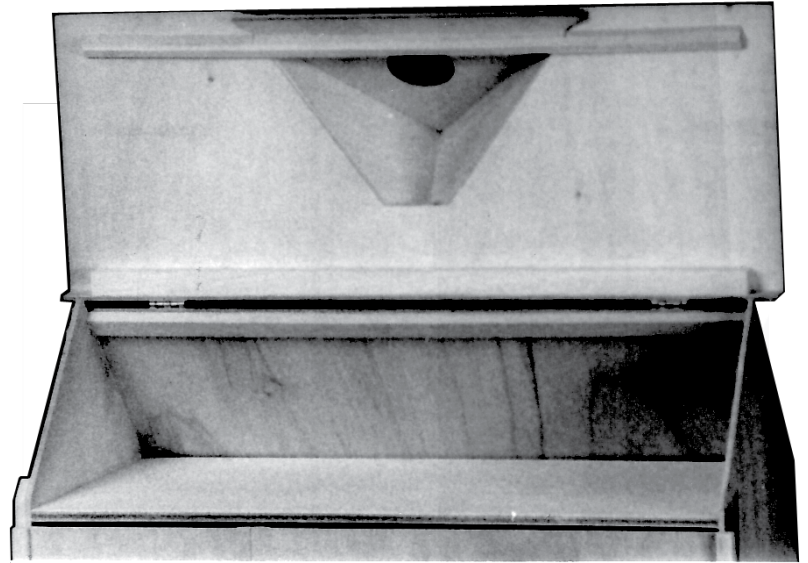
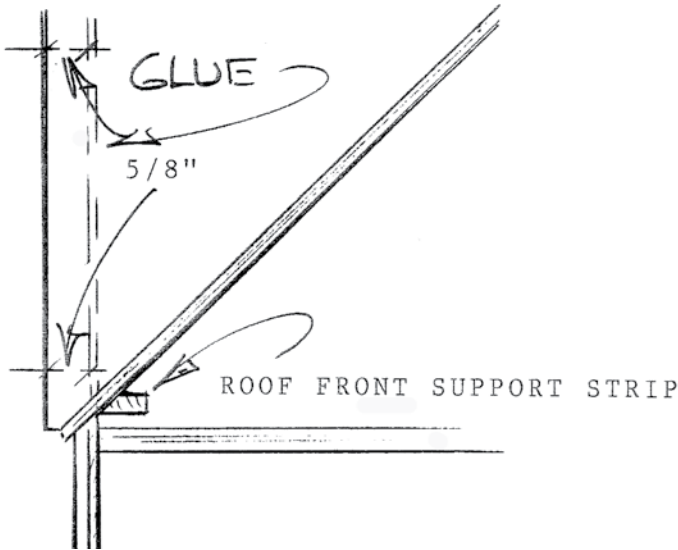

31. Glue together the Window Interior Trim. When the Window Frames are dry, turn them over and glue Window Spacers to the back, lined up on the inside edge.

32. Lay the house on its back; glue the Shutters to the Front panel with the Spacers in the window cutout. Line up the Shutters with each other all the way across the Front using the clapboard profile as a reference or by laying a straight-edge under the shutters. Glue the Lintels to the window tops, centered side-to-side. Install the Flower Boxes and Flowers.

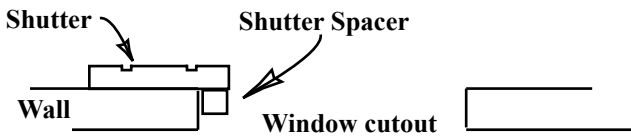
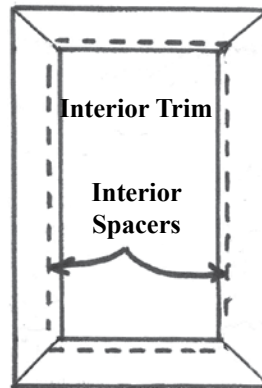

The Window Pane and Interior Window Trim will be installed as part of the Interior Finishing

33. Install the Door from the outside. You will glue the Interior Door Trim to the inside after interior finishing is done. Insepect the fit of the Door Interior Trim before gluing it in place, you may wish to customize the fit. Test it and see.

34. Glue and tape the Gable Gingerbread (shorter) under the Gable Roofs, and the Eave Gingerbread (longer) under the roofs at both ends. Space them 1/8" in from the edge of the roofs. Install the Octagonal Window Exterior Trim. Glue the Gable Trim to the bottom edge of the Gable Triangle if desired.

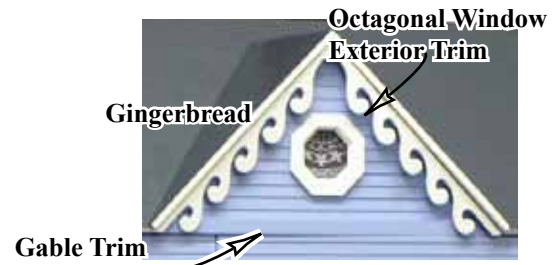

**Finish the Inside...Plan Ahead!**

Interior finishing involves so many choices! Will this house be a play-house or a display for miniatures? What accessories will be used and where will they go? Wiring? Wallpaper? Tile or carpeting? Every choice makes a difference in the order of finishing. Real Good Toys has provided materials for some basic interior work, but you may choose to do it differently. Make your choices

Get your materials  
Test your layout

**With the pieces in your hands**, imagine the steps to get to where you want to be. Now you're ready for **your** order of interior finishing. Here's the order that our assembly pro follows for tackling most custom interior finishing:

- Dividers
- Electrical wiring (using "tape" style wiring)
- Wallpaper (using methylcellulose paste)
- Interior Window and Door Trim
- Flooring
- Stairs and Landing
- Baseboard and crown moldings
- Magnet (if the Front has a bouncy corner, put it there)

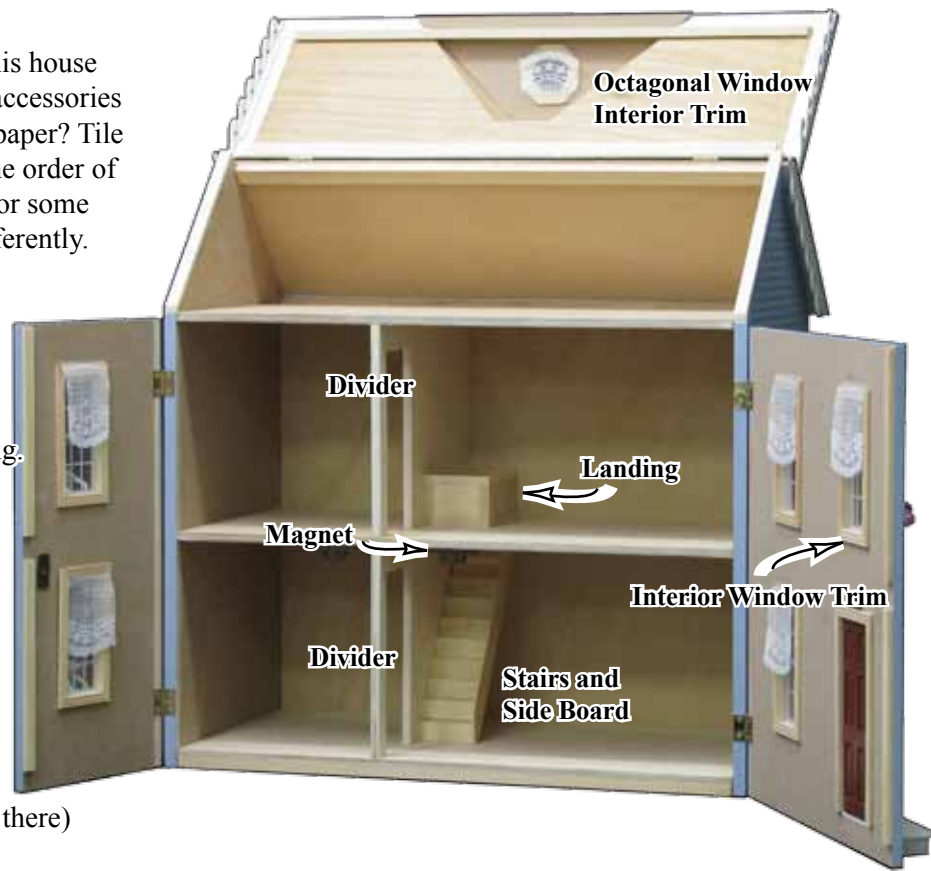

1. Assemble the Dividers: Dividers can be assembled as shown below or they can be used without the doorway parts for easier access. Play around with the parts to determine your favorite interior plan. Glue and tape together the Divider parts against a straight-edge at the top; make them straight and square!



2. Test the Divider layout without glue... straight front-to-back and up-and-down. Use one Divider to "square up" the other, mark the location for the first, and then test and mark for the second. To glue Dividers in, apply glue, tip the Divider and put it almost all the way in, set the base, lift the floor above for some clearance, tip the Divider upright, and slide it the rest of the way in place; clean-up the excess glue.

3. Install the Window Panes and Interior Window Trim  
Install the Door Trim.

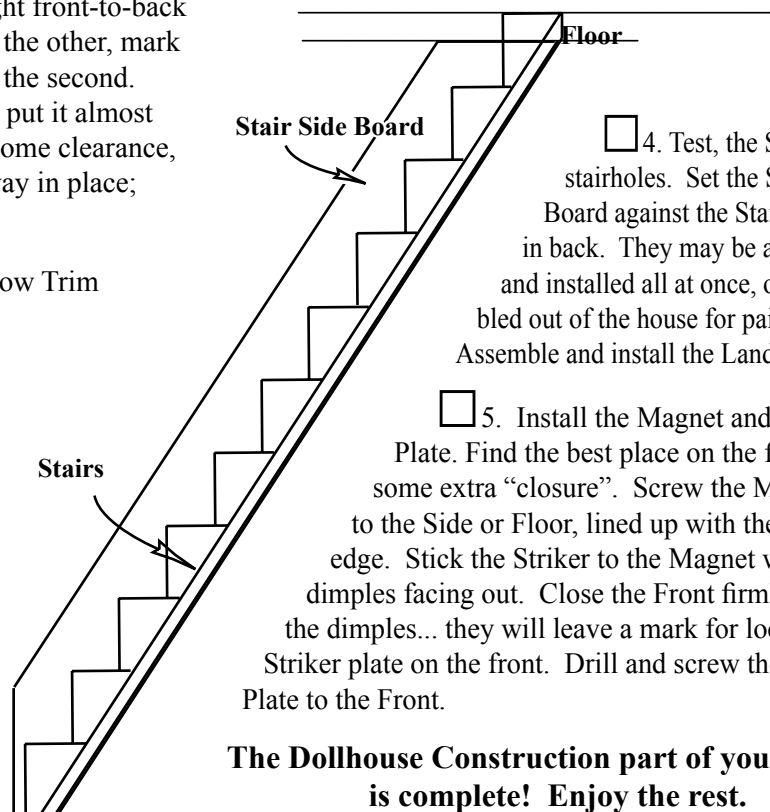
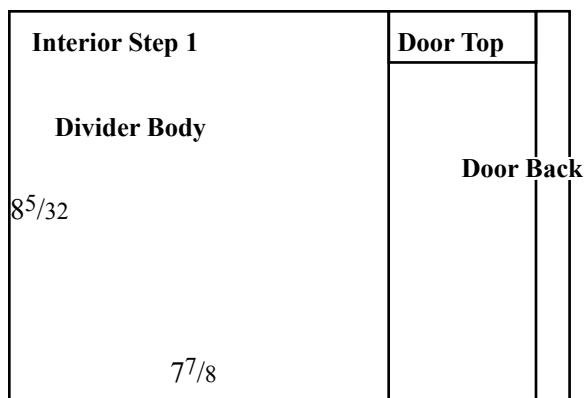

4. Test, the Stairs in the stairholes. Set the Stair Side Board against the Stairs, lined up in back. They may be assembled and installed all at once, or assembled out of the house for painting. Assemble and install the Landing sets.

5. Install the Magnet and Striker Plate. Find the best place on the front for some extra "closure". Screw the Magnet to the Side or Floor, lined up with the front edge. Stick the Striker to the Magnet with the dimples facing out. Close the Front firmly against the dimples... they will leave a mark for locating the Striker plate on the front. Drill and screw the Striker Plate to the Front.

**The Dollhouse Construction part of your project is complete! Enjoy the rest.**