

ALPINE

AL 200 MINIATURE HOUSE KIT

ASSEMBLY INSTRUCTIONS

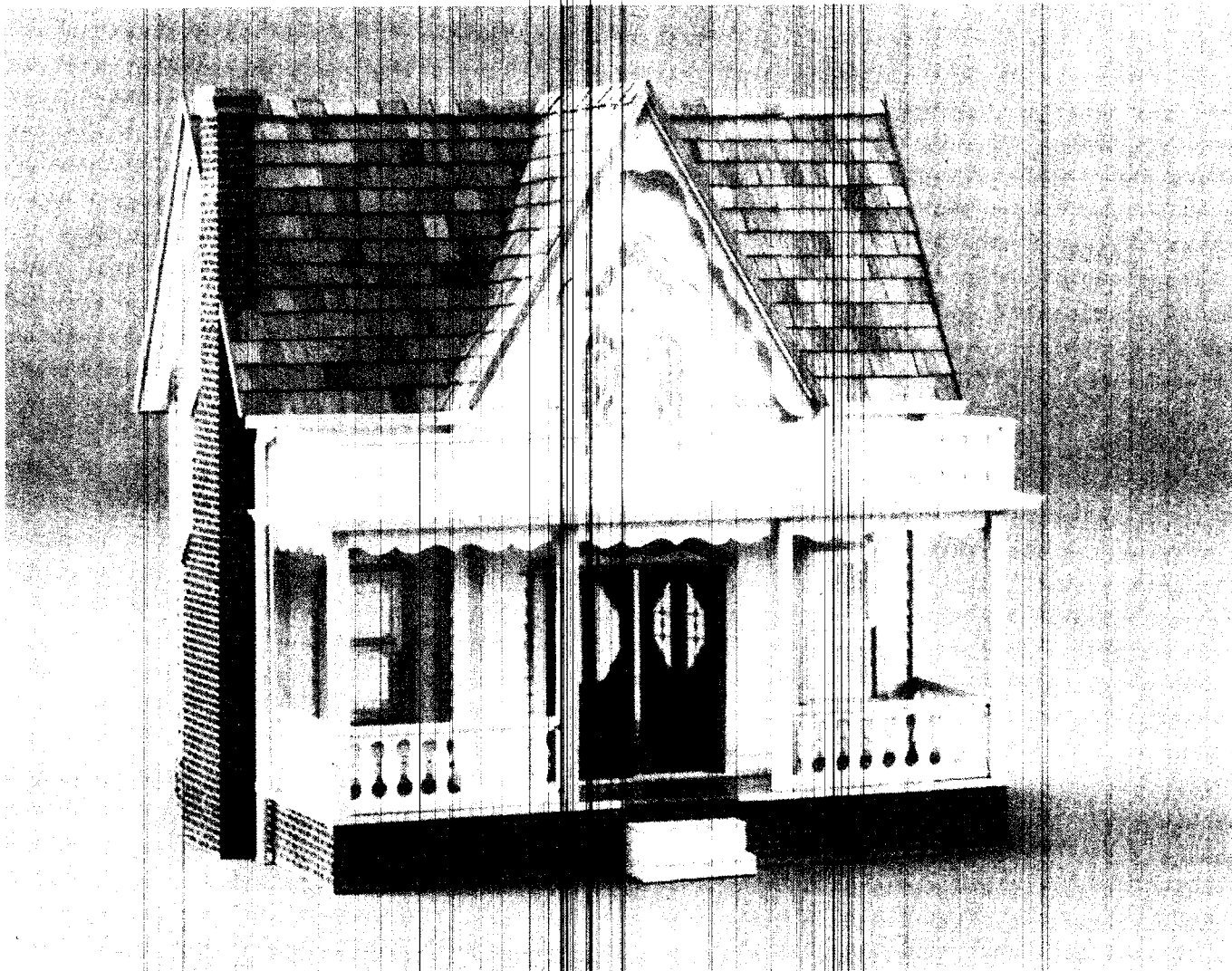

FINISHED SIZE: 23"H X 24"W X 19"D

SCALE: 1" = 1'

Dura-Craft, Inc.

P.O. Box 438 • Newberg, Oregon 97132

phone: (503) 538-3134

PLEASE READ

"THANK YOU for buying a DURA-CRAFT, INC. product.". We bring to you QUALITY and DEPENDABILITY in dollhouse kits. We make every effort to bring you our products in perfect condition but if you find any missing, defective parts, or damaged parts by improper assembly we will send you replacement parts at NO COST TO YOU. Simply fill out the parts form provided in the kit or call us describing the sheet number, part name and number of part or parts you need. Please refer to parts list and drawings in the assembly instructions.

YOU WILL FIND IT IS FASTER & EASIER TO CONTACT US FOR ASSEMBLY ASSISTANCE OR PARTS SERVICE DIRECTLY RATHER THAN THE STORE FROM WHICH YOU PURCHASED IT.

The stores do not carry spare parts and most often call us anyway so you can speed up the process contacting us first.

Should you need more immediate assistance or you require an answer to a question concerning kit instructions you can call us at (503) 538-3136 during normal business hours. Parts inquiries or requests are handled the day they are received so that parts are on their way to you immediately. You can direct your written requests to:

CUSTOMER SERVICE
DURA-CRAFT, INC.
P.O. Box 459
Newberg, OR 97132

Phone (503) 538-3136
Fax (503) 538-3132

NOTICE :

Some people like to fill in the gaps at the top of the interior walls, between wall tops and the underside of roof pieces. You may also want to fill the gaps where the front gables meet the main roof. If you feel these refinements are necessary, we recommend the use of Red Devil one time spackling compound or a similar foam based spackle. Heavier, putty style spackles are more difficult to apply with good results in this particular case.

A Beautiful, Authentic Shake Roof

Using the variables of width and color
to achieve an exciting result.

Building a perfect shake roof requires an understanding of the methods used by roofers in the real world. Shakes are not uniform in width or color, so you need to apply them with these natural variables in mind. At Dura-Craft, Inc., we have gone to some trouble to ensure that you receive a suitable variety of widths and colors. If you create your dollhouse roof with care, it will have a truly authentic, real world look.

Take a look at the illustration below. The first thing you will notice is the appearance of randomness. This is exactly how professional roofers arrange shakes. While making your dollhouse roof, you should keep a

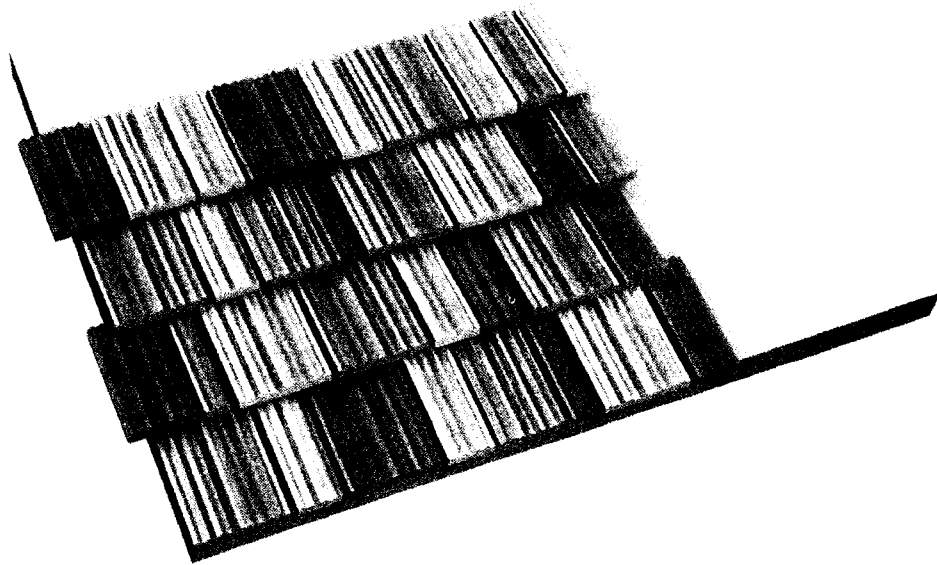

constant eye toward mixing up the way your shakes are applied.

Even more important, the spaces between shakes are arranged so that no space lines up with a space in the row below it.

If you approach your dollhouse roof in the manner shown, you will make the best use of the shakes that Dura-Craft, Inc. has supplied for you, and you will have a dollhouse roof that you can be proud of.

You should not attempt to sort out shakes of a particular size or color in an effort to make a uniform roof. You will lose the wonderful authenticity of the Dura-Craft, Inc. roofing method, and you will run out of shakes long before your roof is complete.

ALPINE

AL 200 MINIATURE HOUSE KIT

Congratulations on selecting a miniature house kit manufactured by Dura-Craft, Inc., the leader in the industry. We pride ourselves in our high quality and workmanship. Each piece is graded and sorted at several different stages to ensure that you receive the finest quality.

A Dura-Craft miniature house is a complete kit. You will not have to make

separate purchases of items like the windows and shingles which are a basic part of your house. Your finished house will be ready for painting, wallpapering and decorating.

Your finished house will be of heirloom quality, of which you will be justly proud, if ample time and care are used in its construction and finishing.

ASSEMBLY INSTRUCTIONS

Here are several construction tips that will help you avoid some problems when you build your miniature house.

An important thing to keep in mind about the kit parts: They are made of wood. Wood shrinks and expands according to humidity. We have found that the siding is most sensitive to dimension changes due to humidity. All siding used in Dura-Craft miniature houses is made from the finest kiln dried Ponderosa Pine. However, as a result of humidity and assembly with a water base glue, some swelling will occur, causing slight dimension changes. Wall panels should be left in a warm dry room at least 48 hours before corner posts are attached. This

will prevent walls from cracking. At no time should the house be placed in a cold damp area.

If there is a minor cracking problem there is a simple solution. A thick bead of glue should be run into the gap. Wipe off any excess glue and allow to dry. If necessary, repeat this step until the gap is filled. When the house is painted, there will be no evidence of the gap. We recommend a good quality OIL base paint be applied on any siding to be painted.

WALL PANELS DO NOT COME ASSEMBLED IN THE KIT. FOLLOW INSTRUCTIONS TO ASSEMBLE WALL PANELS.

NOTE: For shortages or broken parts write directly to Dura-Craft, Inc. for replacement, using the form on the last page of this manual.

READ THIS BEFORE STARTING ASSEMBLY

The following tips will help you avoid problems when you build your miniature house.

1. **Save the box.** The photo will be very helpful during assembly.
2. Do not remove any pieces from their punch sheet before they are called for in the instructions. This will reduce part warpage and make part identification easier. But, if you plan to paint your house it is easiest to paint all parts before assembly. The walls are best painted after they have been glued together.
3. Read through the instructions carefully once to get a feel for the assembly process and to gain familiarity with the parts.
4. Follow the instructions in order.
5. **If you cannot release a part from its board with moderate pressure, then carefully cut it loose with a utility knife. Always cut from the good side of the board where the cut lines are clearly visible.**
6. If any parts are missing or damaged, they can be quickly replaced by Dura-Craft. Please write or call and give us the name and sheet number of the part or parts that you need. We have included a "Missing and Broken Parts Replacement Form" to assist you. It may save time to make missing or broken parts from the scrap material.
7. We recommend the use of Aleene's Tacky Glue to construct your house. This glue helps hold parts in place while it dries, and it dries clear. It can be found at most craft supply stores. Any white household glue or woodworking glue may be substituted if desired. Wipe away excess glue while it is still fresh.

8. Dura-Craft has done everything possible to ensure that your kit will look good when it is complete. We have included pine moldings to strengthen the house and trim to cover all of the outside wall and floor edges, and we have designed the kit so that slot and tab positions will be hidden when the kit is finished. However, the final quality of your house will depend to some extent on the care you take in preparing each piece for assembly. Sanding is optional, but it will improve your house. It will also remove splinters from the edges of the parts which will help the parts fit better.

9. You will need the following materials to assist you in the assembly of your miniature house:

- Glue (see paragraph 7 above)
- Utility knife or sharp, sturdy knife
- 3/4" masking tape
- Damp cloth
- Ruler or tape measure
- Fine toothed saw such as a coping or hacksaw is helpful
- Pencil
- 100 grade (med.) sand paper
- A roll of waxed paper
- Several large books to use as weights
- A framing square
- Contact cement (for hardwood floor)
- Steel wool (for hardwood floor)
- Small "C" clamps come in handy

GLOSSARY

- Good side- The side the pieces were stamped from. The smoothest side.
- Bead of glue- A line of glue about as large as a pencil lead.
- " - inches.
- Flush- When the edges of two boards are even.
- Left and right sides- All references will be made from the front view, unless otherwise instructed.
- Tab- A projection off the edge of a board.
- Slot- A hole in a board that a tab fits into.
- Notch- The same as a slot, except it's on the edge of a board.
- Glass- Silkscreened plastic sheets

INVENTORY LIST

Part No. AL-1 through AL-13

13 stamped sheets of parts (See back of instructions)

Siding:

Part No.	Length	Quantity
1-9	1 1/4"	18
1-41	1 1/2"	1
1-36	1 3/4"	2
1-11	2"	22
1-5	2 3/4"	4
1-32	3 1/8"	3
1-37	5"	8
1-27	5 1/4"	1
1-6	5 1/2"	1
1-31	7"	5
1-42	9 7/8"	1
1-43	10 3/4"	5

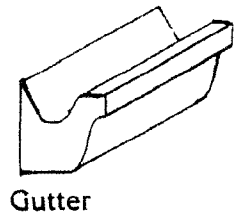
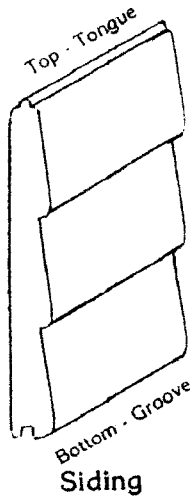

Part No. 5-143

1 1/2' of downspout



Downspout

Part No. 6-32

1 silkscreened sheet of windows

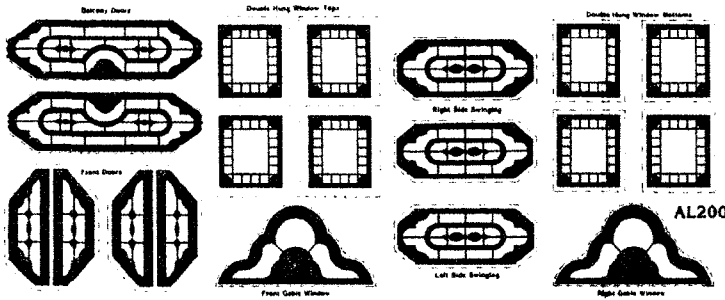

Part No. 6-2

50 small dowels (1/8"x2")

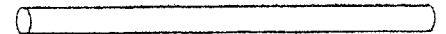

Small Dowel

Part No. 6-17

9 pc. door knobs



Part No. 6-19

76' of hardwood flooring



Hardwood Flooring

Part No. 5-150

800 plain shakes (1 1/8")

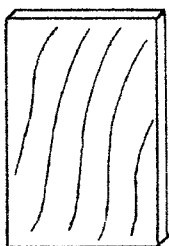

Plain Shake

Part No. 5-74

4 - 13" pcs. of large corner post

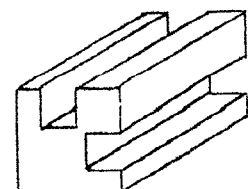

Large Corner Post

Part No. 5-145

2 - 16½" pcs. of large corner post

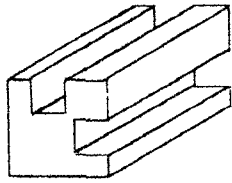

Large Corner Post

Part No. 5-70

12' of small edge trim

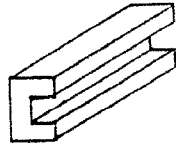

Small Edge Trim

Part No. 7-1

14' of brick template tape

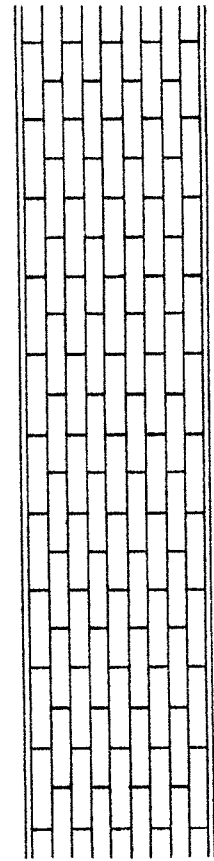

Part No. S5-2

1/2' of small corner post

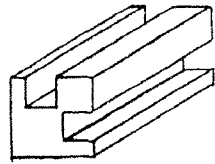

Small Corner Post

Part No. 5-144

4 pc. 1/2"x1/2"x8 1/8" molding

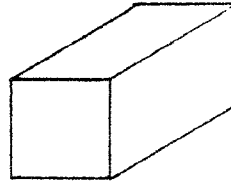

½" x ½" Molding

Part No. S5-76

3 1/2' of small tower corner post

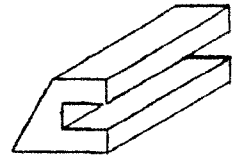

Small Tower Corner Post

Part No. 5-46 Stock

4' of 1/4"x1/4" molding

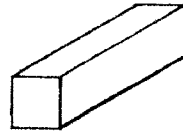

¼" x ¼" Molding

Part No. 5-3

34' of universal trim

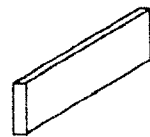

Universal Trim

Part No. 7-2

14 oz. brick powder

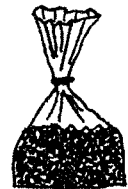

Part No. 5-73

2 - 13" pcs. of large edge trim

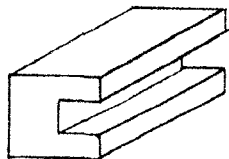

Large Edge Trim

Part No. 5-19

6' of redwood trim

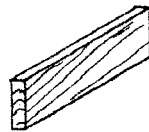

Redwood Trim

Part No. 5-41

2' medium edge trim



BASE

1. Locate base floor back, base floor front, and left, middle, and right base floor splices (Sheets AL-1,2,3). With the good sides of the floor parts facing down splice base floor together by gluing and taping the splices in place. Sand the edges to be spliced. Splices must be at least 1/8" away from floor edges. Figure 1.

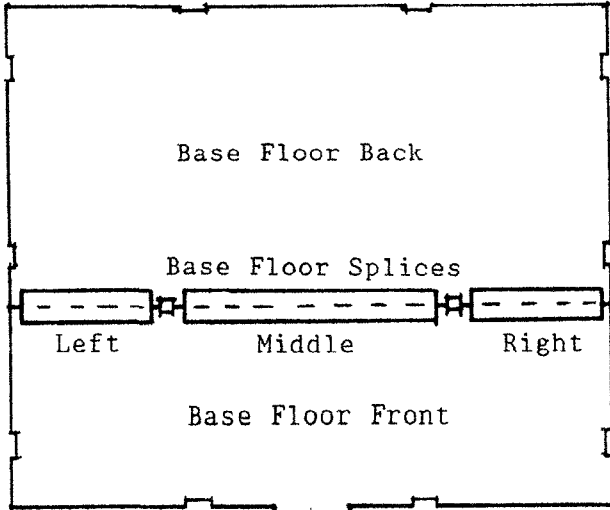

Figure 1

2. Locate the front, back, left, and right base walls, and the front-to-back and side-to-side base floor supports (Sheets AL-2,4,6,8). Interlock and glue parts together as in Figure 2.

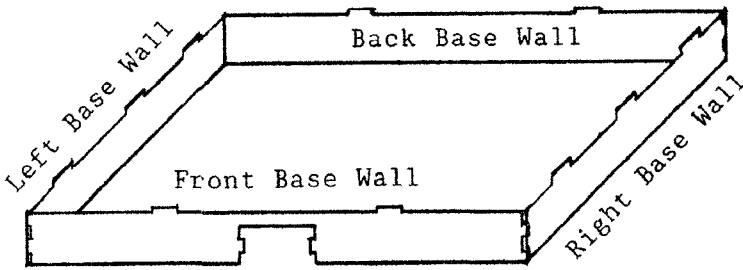
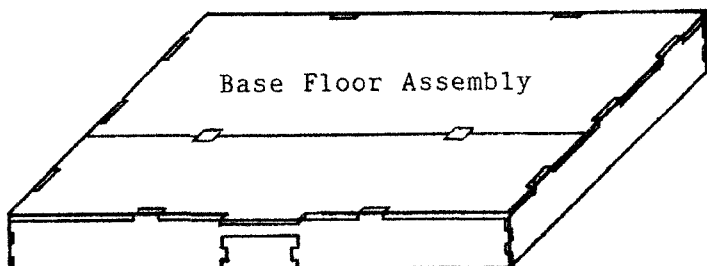

Figure 2

3. Glue and tape the base floor assembly onto the base walls as in Figure 3.



Base Wall Assembly

Figure 3

4. Interlock and glue the base floor supports to the underside of the base.

WALL PANELS

1. Locate all siding pieces.
2. Pre-assemble the siding without glue. Lay the pieces flat side down, as shown in Figure 4. The tongue is on the top edge of each board.

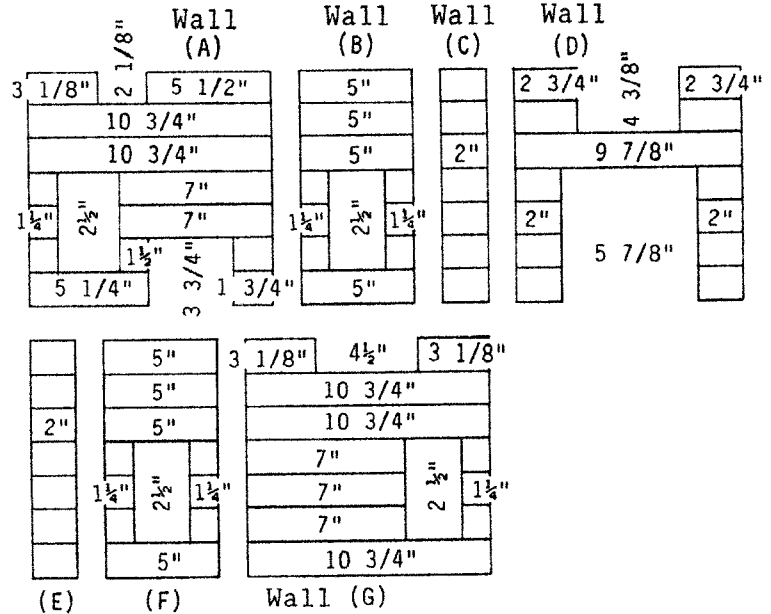

Figure 4

3. Use a framing square to insure that the ends of the siding pieces are properly aligned. Make light pencil marks at the top and bottom of each window and door opening for final assembly.

4. Prepare an area for gluing. You will need a hard, flat surface at least three feet by four feet in size. Select a location where the wall panels will not have to be disturbed for several hours after gluing. Tape waxed paper over the entire surface.

5. Use the following technique for gluing the wall panels: Apply a thin bead of glue to the tongue then seat it in the groove. Immediately wipe off any surplus glue that squeezes out, using a damp- but not wet- cloth. Assemble the panels flat side down on the waxed paper. Make sure that all parts are arranged in the correct sequence relative to the pencil marks made in Step #3 above for the door and window openings.

6. Make sure that all joints are tight, and that edges of the walls are square and flush. Place weights on the panels as you finish them. Allow about an hour for the glue to set before moving or adding to the panels.

IMPORTANT: If you must leave the wall panels incomplete for more than two or three hours during this phase of the construction, stand them on edge to allow air to circulate around both sides. This will minimize the likelihood of warping.

7. When wall panels are complete and have set for about an hour, stand them on edge to allow air to reach both sides. Let wall panels dry in a warm, dry place for at least 24 hours, preferably 48 hours.

SECOND STORY FLOOR SUPPORTS

1. From the $1/4" \times 1/4"$ molding (Part No. 5-46 Stock) cut:

- 2 - $10 \frac{3}{8}"$ lengths
- 1 - $9 \frac{1}{2}"$ length
- 2 - $4 \frac{5}{8}"$ lengths
- 2 - $1 \frac{5}{8}"$ lengths

2. Lay the walls flat side up and make marks $8 \frac{1}{8}"$ from the bottom of each wall. Sometimes the marks will be on the siding junction line, but not always.

3. Glue the 2nd floor supports ($1/4" \times 1/4"$ pieces) to the walls with the top edge of the supports on the marks. Center the supports on the wall (there should be $3/16"$ of wall past each end of the supports). Figure 5.

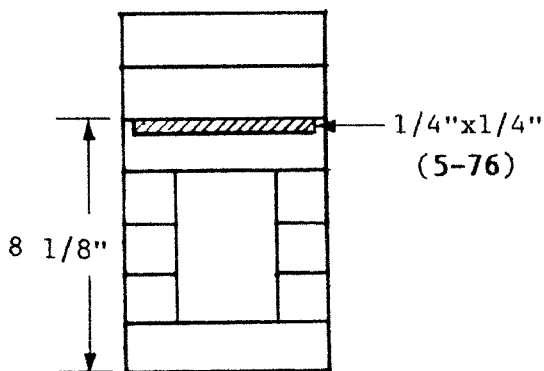

Figure 5

4. You may need to trim off the tongue of the piece of siding on the front middle wall if it is higher than the 2nd story floor support.

PAINT AND WALLPAPER

1. After the 48 hours, we recommend sealing the siding with a sanding sealer or other non-water based sealer. This will keep moisture out of the wood and prevent cracking. Seal the inside and the outside of the siding.

2. Painting is optional, and the house will look good unpainted. If you decide to paint, a better paint job is attained when all of the parts are painted prior to assembly as opposed to painting the house after it is assembled. The danger of painting before assembly is that you run the risk of losing parts or not being able to identify the loose parts. Also these instructions refer to the good side of the stamped parts. This is the smoothest side, the side the boards were punched from. For non-directional parts, it makes less difference, but for directional parts it makes all the difference. Therefore, if you plan to paint before assembly then, gather all of the parts for each assembly, such as all front door parts, and put them in a bag. Keep these parts together until installed on the house. When the good side is called for, refer to the board diagrams at the back of the instructions for proper direction.

3. Lightly sand the punched edges of all parts to remove burrs.

4. Seal all parts with a non-water based wood sealer (Optional on Sheet parts).

5. Paint all parts desired colors. Many parts only need one side and the edges painted since they will be glued to another surface.

6. Add wallpaper to appropriate wall panels. Refer to Figure 6 for top view wall layout. It will help conceal seams in wall paper if you paint the wall the same color as the background of the wallpaper where the seams will occur.

GLUE WALLS TOGETHER

1. Locate the Large Corner Post Molding:

Part No. 5-145 2 - 16½" lengths
 Part No. 5-74 4 - 13" lengths

2. Locate the Large Edge Trim Molding:

Part No. 5-73 2 - 13" lengths

3. DO NOT glue the walls to the base at this time. But, use the base to assemble the walls together.

4. To assemble the walls run a bead of glue on the edges of the walls, then fit the walls into the grooves. Wipe away excess glue with a damp cloth. **Fully seat the walls into the grooves.** It may help to lightly sand the edges of the walls to remove burrs. Make sure there is no paint in the grooves of the posts. Make the bottoms of the 13" posts (5-74) flush with the bottoms of the walls and the 16½" posts (5-145) 2" below the bottom of the walls.

5. The two 16½" lengths protrude through the holes in the floor. Figure 6.

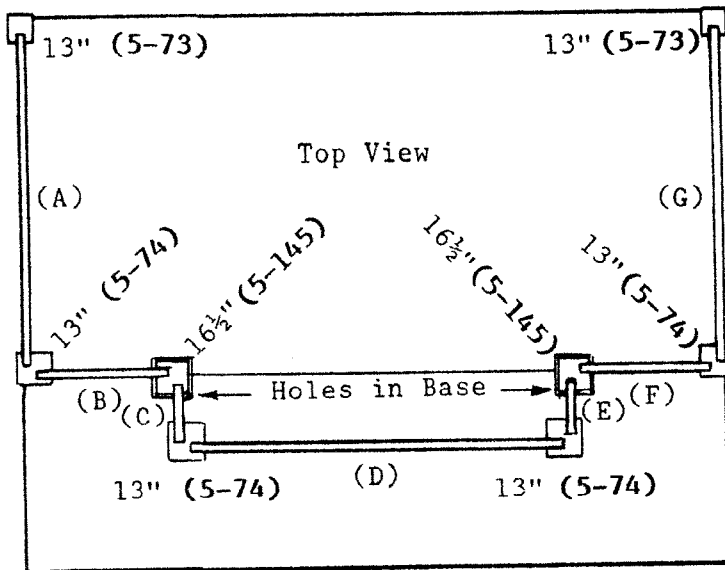

Figure 6

DOUBLE HUNG WINDOWS (DHW)

1. Locate inside and outside double hung window surrounds, frames, decorative emblems, sills, and sliders (Sheets AL-3, 6, 8, 9, 13).

2. Cut out glass- "Double Hung Window Tops" (Cut these on the inside edge of the dotted lines so no dotted lines remain) and "Double Hung Window Bottoms".

3. Lay an outside surround/frame (the outside frame remains connected to the outside surround) on a table with the good side down. Run a thin bead of glue around the outside frame window opening. Spread glue evenly. With clean hands, place glass on the frame, make sure it is centered. With a pencil, press the glass down for full contact with the glue. Figure 7.

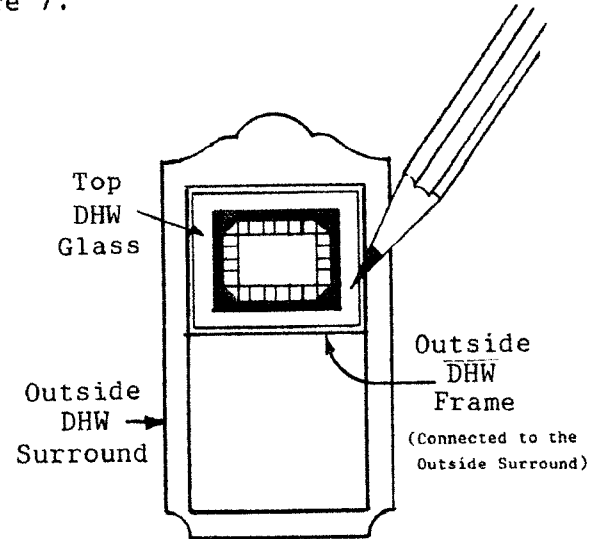

Figure 7

4. Lay the inside frame on the table with the good side down. Run a thin bead of glue around the opening. Spread glue evenly. Place the glass on the glue. Press glass down with a pencil. Run another bead of glue on the glass and spread evenly, be careful not to get glue on the part of the glass that will be seen.

5. Lay a slider on the table with the good side down. Place the inside frame on the slider. Be sure it is centered. There should be 1/16" of slider past the edge of the frame. Figure 8.

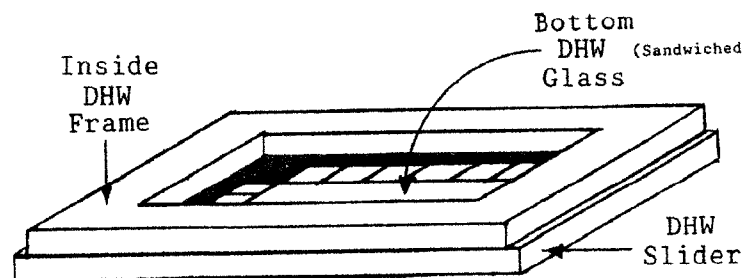
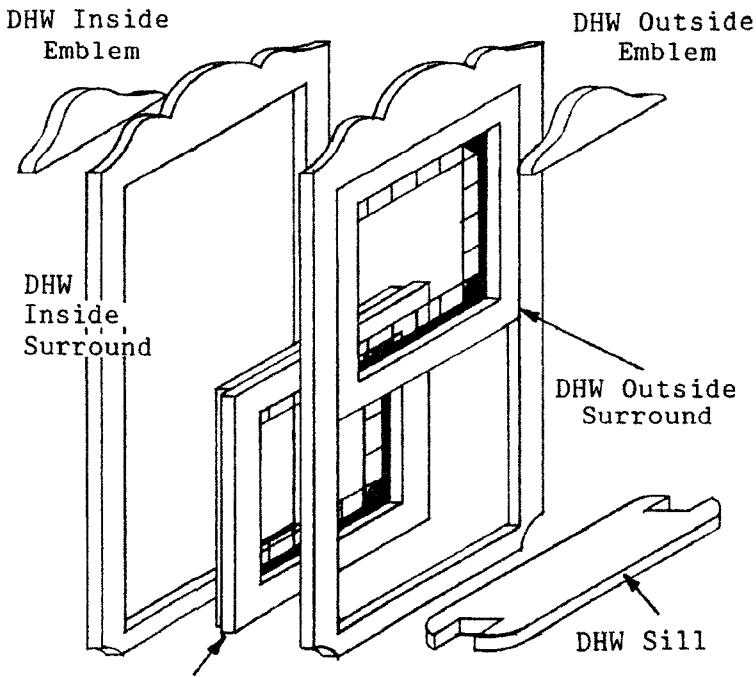

Figure 8

6. Dry fit the double hung window assemblies into the walls to be sure of proper operation. To do this, tape the outside window surround centered on the outside of the window opening in the wall. From the inside, insert the slider assembly into the wall opening with the inside frame to the inside. Tape the inside window surround centered on the inside of the window opening in the wall. Raise the slider up and insert the sill diagonally and slide down. This process will tell you if you need to sand excess paint or burrs from the slider or surrounds for proper operation. Figure 9.



DHW Inside Frame/Slider Assembly

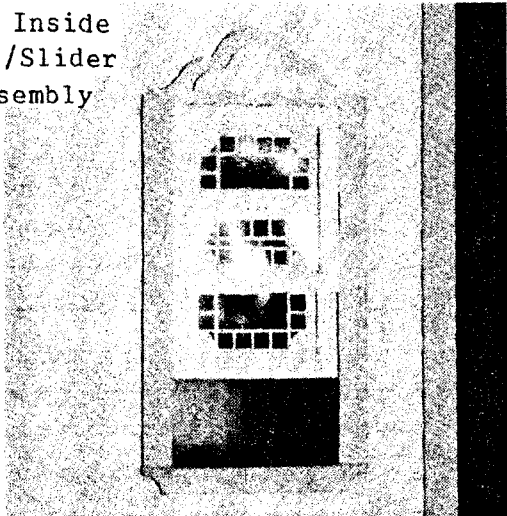

Figure 9

7. Glue in place. This may be done now or you can disassemble the window and glue one piece at a time. Make sure you don't get glue on any surfaces that the slider will come in contact with.

2ND FLOOR

1. Locate the 2nd floor back, 2nd floor front, and 2nd floor splice (AL-3,4).
2. Lay the floors facing down on the table. Glue the splice centered as in Figure 10.

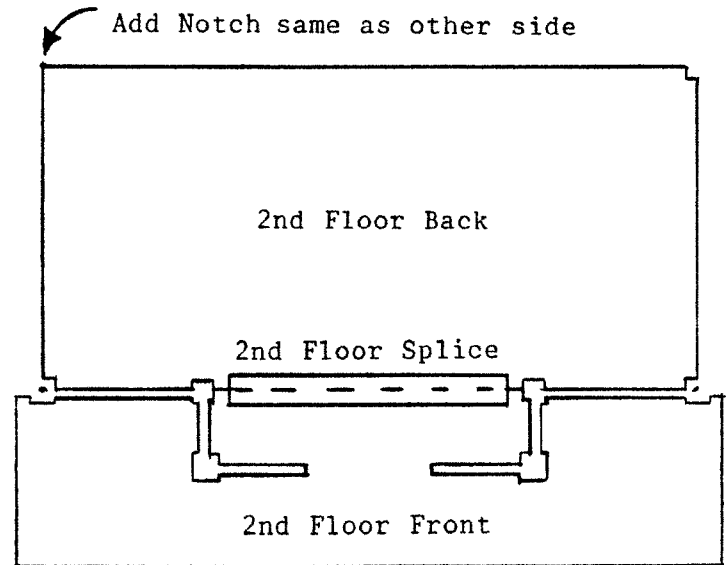

Figure 10

3. Add a notch 1/8"x1/4" as indicated in Figure 10.
4. From the medium edge trim (5-41 stock), cut a 20 3/8" length.
5. Run a bead of glue along the top of the 2nd floor supports.
6. Slide the 2nd floor down the walls with the good side up until it rests on the supports.
7. Cut notches on the ends of the 5-41 to accommodate the 2nd floor supports. Glue the 20 3/8" length of 5-41 to the back edge of the 2nd floor. Wrap a piece of tape around the corner of the wall and onto the 5-41 on each end to hold the walls from spreading. Place weights on the second floor around the edges.

HARDWOOD FLOORING

The hardwood flooring kit contains enough hardwood strips to cover **only** one floor of the house. This material may alternatively be applied to the door, stairways, or be used as wall paneling, but not all. **Do not use water base glue for flooring as it will cause the hardwood strips to curl.**

1. Lift off and set aside wall assembly.
2. The edges of the hardwood strips may need to be **lightly** sanded to remove burrs.
3. Brush contact cement on the base floor and on one side of the hardwood strips. Follow the instructions on the contact cement.

WARNING: Contact cement is extremely volatile and flammable. The working area must be well ventilated. Keep away from flame or sparks.

4. Start laying the hardwood strips at the back of the house and work toward the front. Cut the strips with scissors. Off-set the joints as shown in Figure 11.

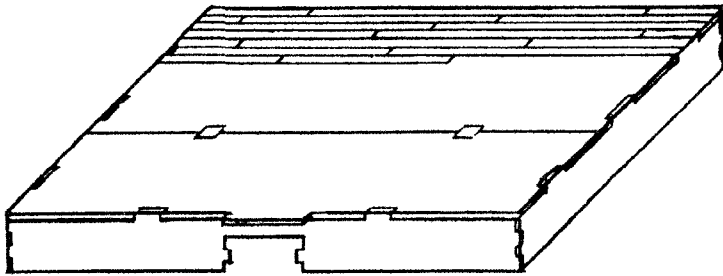

Figure 11

5. After the hardwood strips are in place, burnish them down by rubbing them firmly with a small wood block.

6. To achieve a pegged appearance, punch the ends of each strip with a 3/32" nail set as in Figure 12.

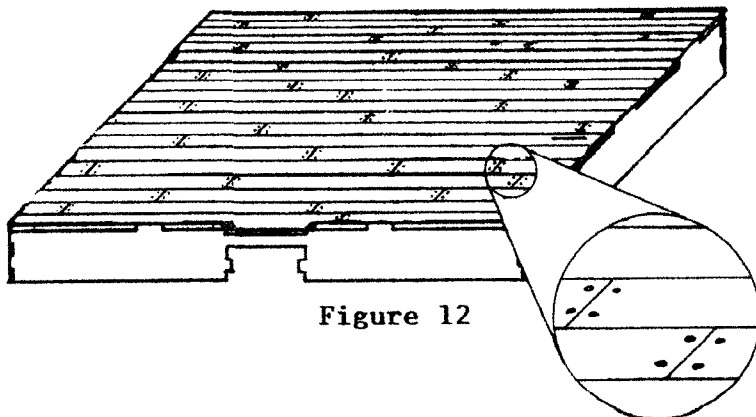

Figure 12

7. Sand the flooring smooth and remove any traces of contact cement that would interfere with the positioning of the walls on the base.

8. Using a sharp knife, carefully cut the flooring away from covering the square hole in the floor. This is best done from the underside of the floor.

9. **DO NOT VARNISH THE FLOOR YET!**

VARNISH PREPARATION

The following procedure may seem complicated and cumbersome, but it is necessary to prevent the varnish that will cover the floor from covering the areas where the walls need to glue to the wood.

1. Set wall assembly on base.
2. Lightly trace the inside and outside of the walls onto the floor with a pencil.
3. Remove the walls.
4. Apply masking tape over the pencil marks.
5. Set the walls on the base again.
6. Again, trace the walls onto the tape.
7. Remove the walls.
8. Using a knife cut through the tape on the pencil lines.
9. Remove the outer edges of the tape, leaving the portion of tape where the walls had set. Figure 13.

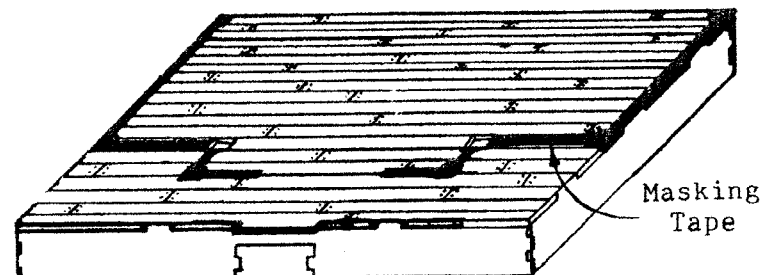

Figure 13

10. Varnish the hardwood flooring with two or three coats of satin sheen polyurethane varnish. Steel wool lightly between coats.

11. After the varnish has dried, remove tape.

BRICKWORK

1. Mask the hardwood flooring with tape and paper to prevent paint from the bricking process from getting on the floor. Also mask the two tabs that glue to the front steps.

2. Paint the base walls. This paint will become the mortar lines between the bricks. Black, white, and grey are popular. Let dry.

3. Stand base up on back base wall.

4. Peel approximately 23" of webbing from the brick template tape. Stick it to the front base wall leaving about 2" hanging off one end and one full row of bricks over the bottom edge. Press firmly for full contact.

5. Carefully trim the extra row off. Save this row, you may be able to use it later on the fireplace or chimney. Figure 14.

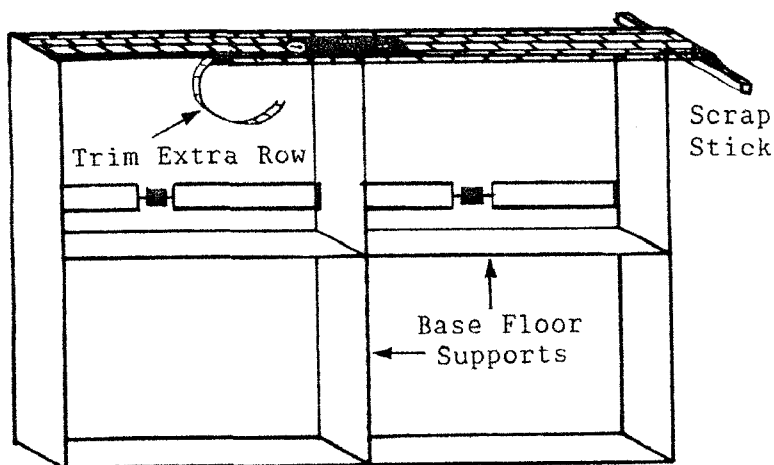

Figure 14

6. Do not cut out the webbing from the front step hole.

7. Stick a scrap piece of wood about 4" long to the overhanging webbing.

8. To cover 1 foot of brick template tape it takes 1 ounce or 1 ½ tablespoons of brick powder. Put about 3 tablespoons of Tacky glue (or other white glue) into a cup, add about 1 ½ tablespoons of water to the glue. Mix well. Put about the appropriate amount of brick powder for the length of surface you are going to immediately brick into a different cup. **Slowly add small amounts** of glue mixture to the brick powder (It is easy to add too much glue mixture). Mix after each addition. Continue until mixture starts to hold its own shape.

9. Spread brick mix over webbing with a putty knife until it is about 1/16" thick. If you would like to paint the brick to change its color or give it an aged look, then spray it now before the webbing is removed.

10. Remove the webbing while the brick is still soft. Roll the stick under and raise it up so the webbing is at about a 45 degree angle to the surface. Keep rolling the webbing onto the stick. If needed, touch up the bricks while they are still soft. Figure 15.

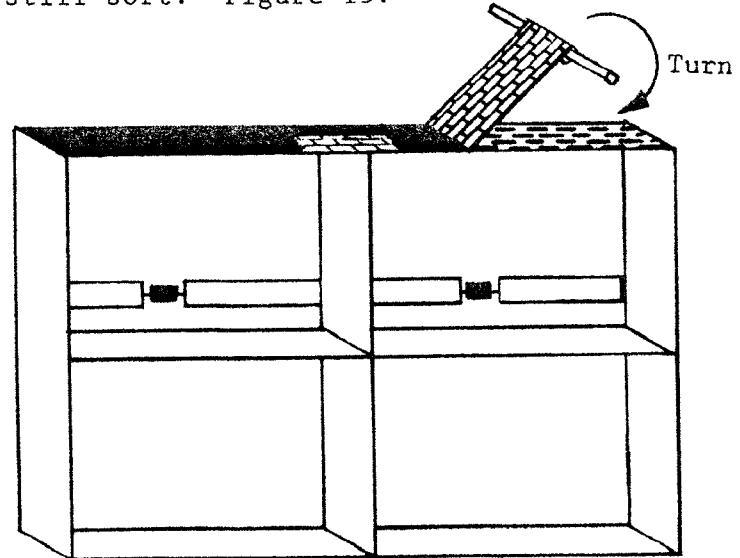

Figure 15

11. Use the same process for the rest of the base.

12. Locate the chimney parts (Sheet AL-12). Assemble as in Figure 16.

13. Locate the fireplace parts (Sheet AL-12). Assemble as in Figure 17.

14. Paint and brick chimney and fireplace. Web and brick one strip of webbing at a time. Offset the mortar lines of the webbing so that the alternating brick pattern continues up the chimney.

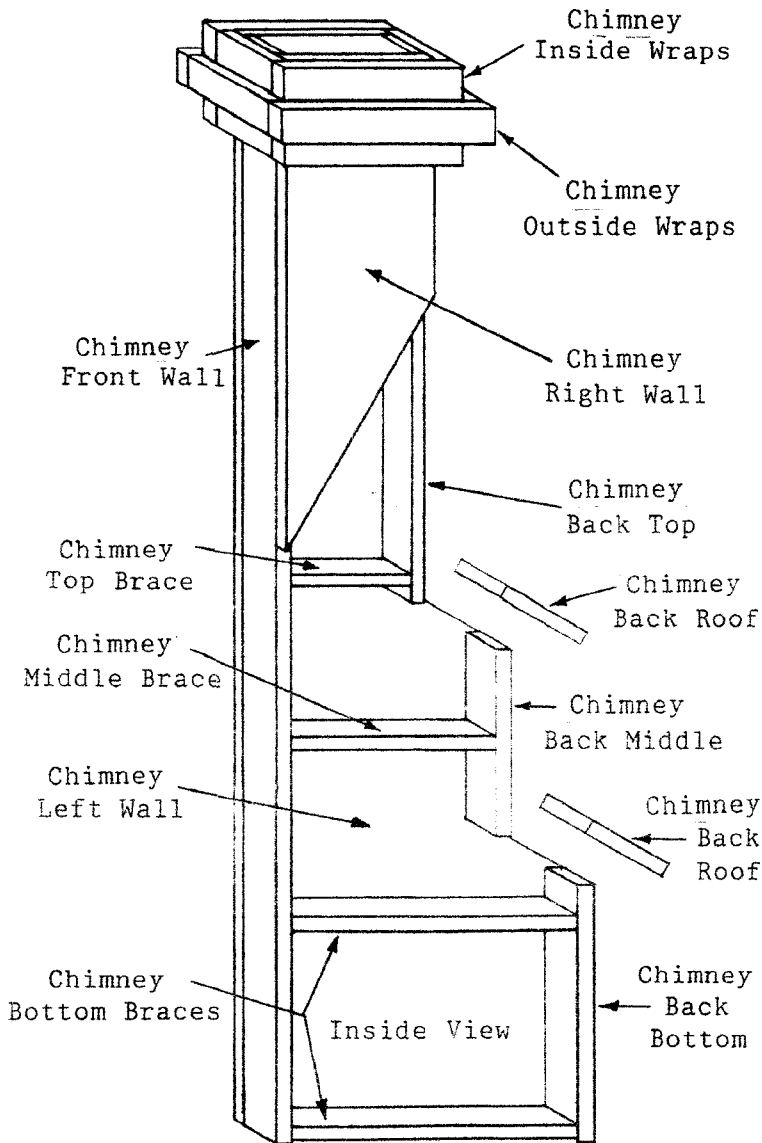
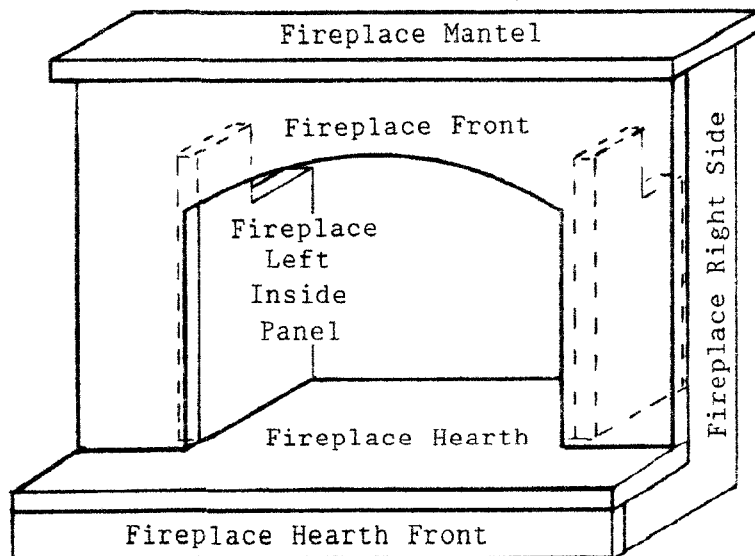

Figure 16



AL 200 Page 12 Figure 17

GLUE WALLS TO BASE

1. Run a bead of glue along the underside of the walls.
2. Set walls on base. Place weights on 2nd floor. Let dry.
3. Glue scrap pieces from the inside of the window frames into the grooves of the large corner posts under the base floor. This will help strengthen the house by not letting the walls pull up. Figure 18.

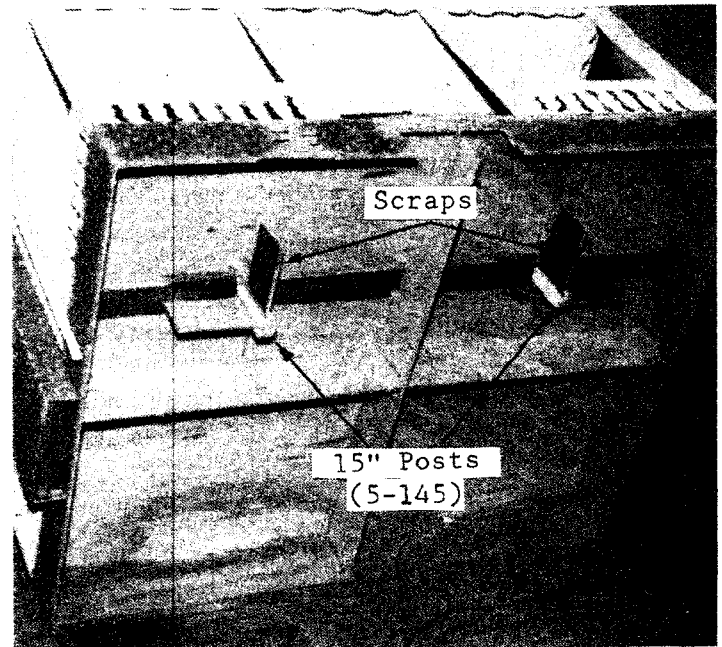

Figure 18

FRONT DOOR

1. Locate front door inside and outside panels, inside and outside surrounds, front door emblems, decorative inserts, and top and bottom pivot plates (Sheets AL-11,12).
2. Cut out "Front Door" windows.
3. Lay the outside front door panels on the table with the good side down. Run a bead of glue around the window openings. Place the glass on the glue and press down with a pencil.
4. Add glue to all exposed wood. Lay the inside panels on the outside panels so that the pivot pins line up. Tape the panels together until dry. Figure 19.

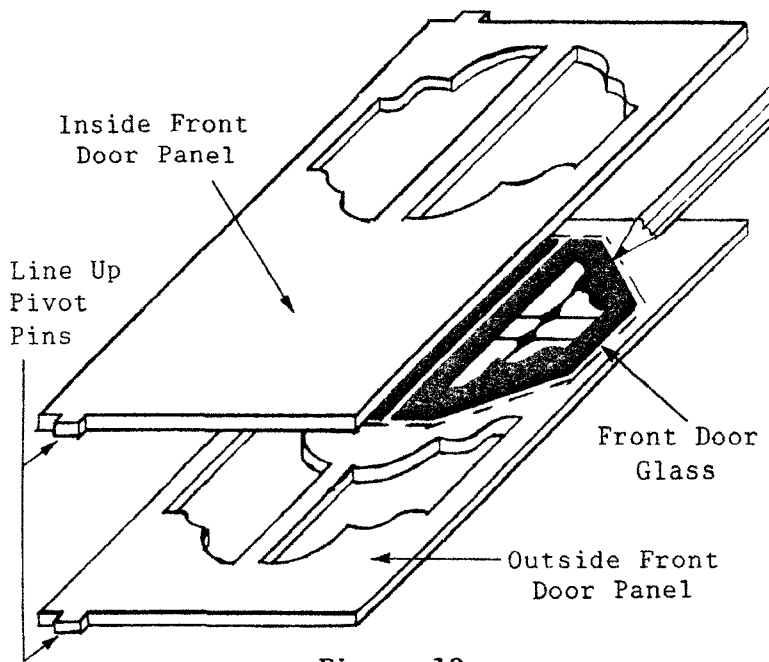

Figure 19

5. Glue the decorative inserts to the inside door panels. See front view.

6. Sand or carve the pivot pins round so they will snugly fit into the holes in the pivot plates. Figure 20.

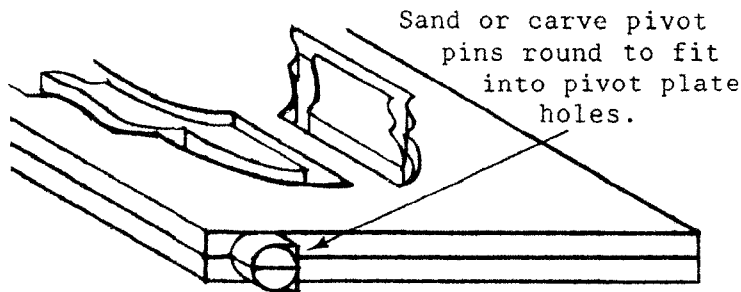

Figure 20

7. Dry assemble the door parts into the front door wall opening. To do this, tape the inside and outside front door surrounds centered on the front door wall opening. Fit the front door pivot pins into the top and bottom pivot plates. Slide doors and pivot plates into the doorway. If doors operate smoothly, then glue assembly together. Figure 21.

8. Glue front door decorative emblems to the top of the top pivot plate.

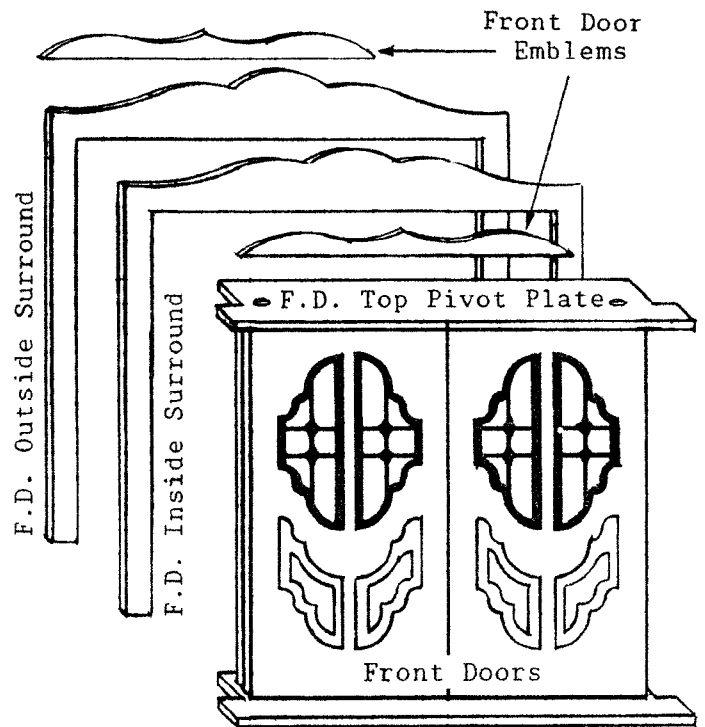

Figure 21

FRONT PORCH

1. Locate 4 porch posts (1/2"x1/2"x8 1/8" molding- Part No. 5-144).

2. Locate porch rails and porch scrolls (Sheet AL-3,4,11).

3. Use the Small Edge Trim (Part No. 5-70) to cap the top and bottom of the rails. Figure 22.

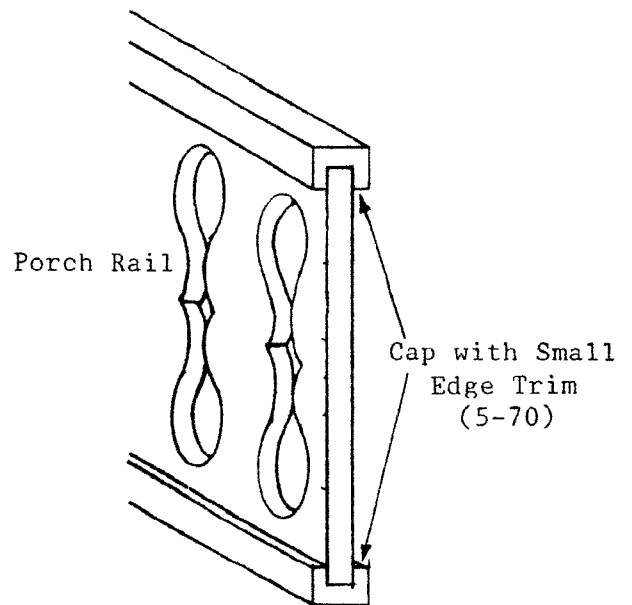
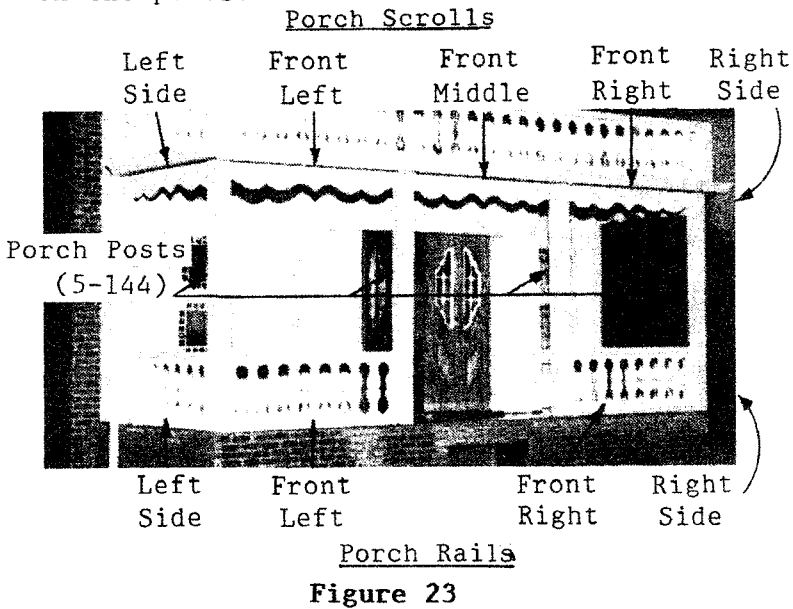

Figure 22

4. Assemble as in Figure 23. Notice the ends of the rails and arches are centered on the posts.



5. Glue front porch assembly in place. Set weights on porch roof.

STAIRCASE

1. Locate staircase and closet parts (Sheet AL-7,9,12).

2. Assemble 7th staircase tread, closet top pivot plate, and door stop as in Figure 24. The good sides are facing away.

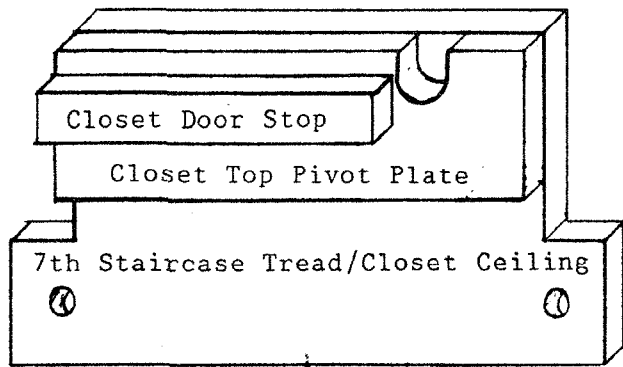

Figure 24

3. Glue the inside closet door pivot pin to the closet door as in Figure 25. Round the pins as with the front door.

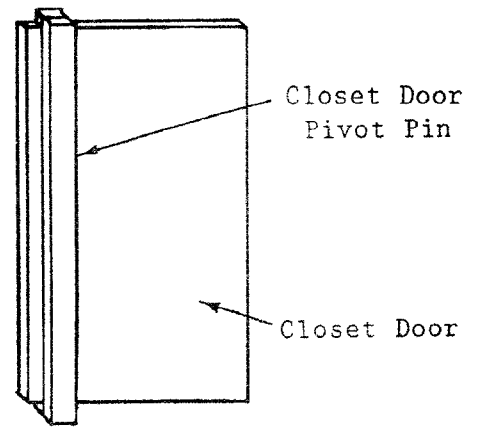

Figure 25

4. Assemble the staircase and closet door as in Figure 26.

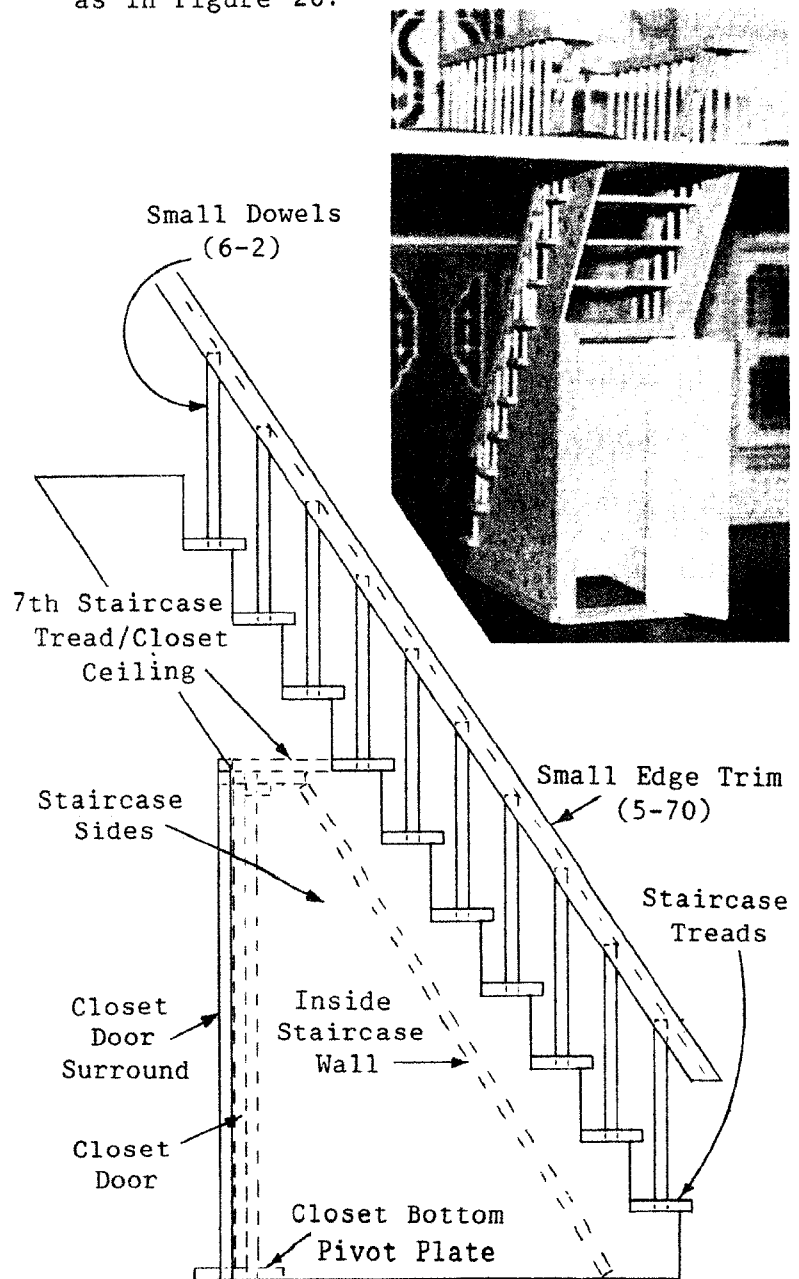

Figure 26

5. Glue small dowels (Part NO. 6-2) in holes in treads. Cut to fit small edge trim for handrails up staircase.

6. Glue staircase in place. See back view.

7. Glue small dowels in holes around 2nd floor stairwell opening. Cut to fit small edge trim for handrail.

GABLES

1. Locate left, front, and right gables (Sheet AL-8).

2. Cut out "Front Gable Window" and "Right Gable Window" glass.

3. Lay the front and right gables on the table facing down. Run a thin bead of glue around the upper window opening. Spread glue evenly. Place windows on gable.

4. Glue gables to the tops of the walls with the good sides facing out.

5. Use a straight edge to draw a line on the corner posts the same angle as the gables. Cut the posts on these lines. Figure 27. Transfer these angles to the long posts (5-2). Cut 5-2s.

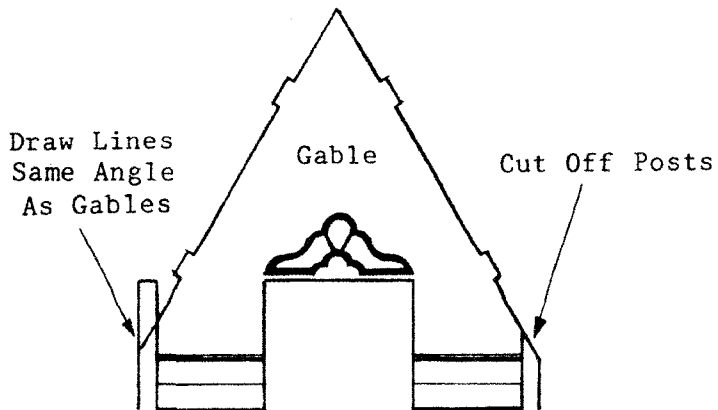
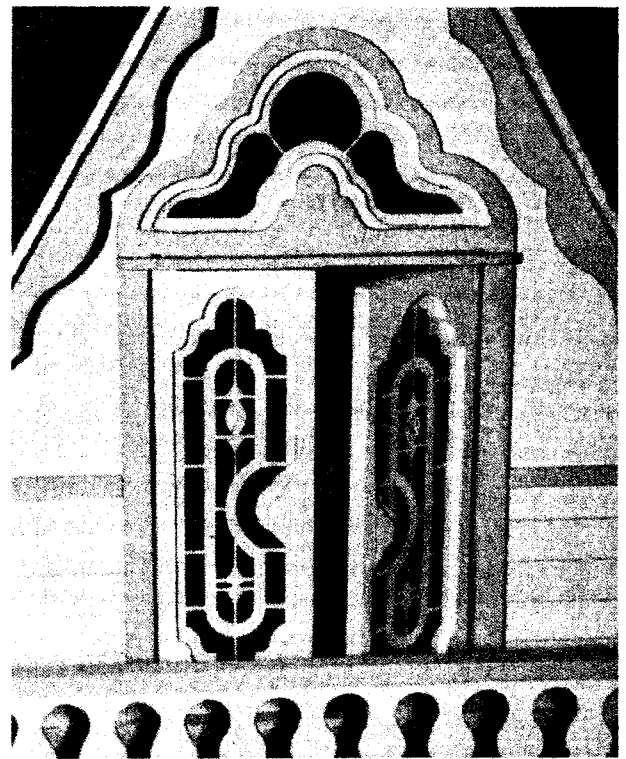

Figure 27

BALCONY DOORS

1. Locate the balcony door parts (Sheet AL-10).

2. Assemble as in Figure 28, using the same process as you did with the front doors.



Balcony Doors

Figure 28

SWINGING WINDOWS

1. Locate the left wall and right wall swinging window parts (Sheets AL-5,9,10).

2. Assemble as in Figure 29, using the same process as you did with the front door.

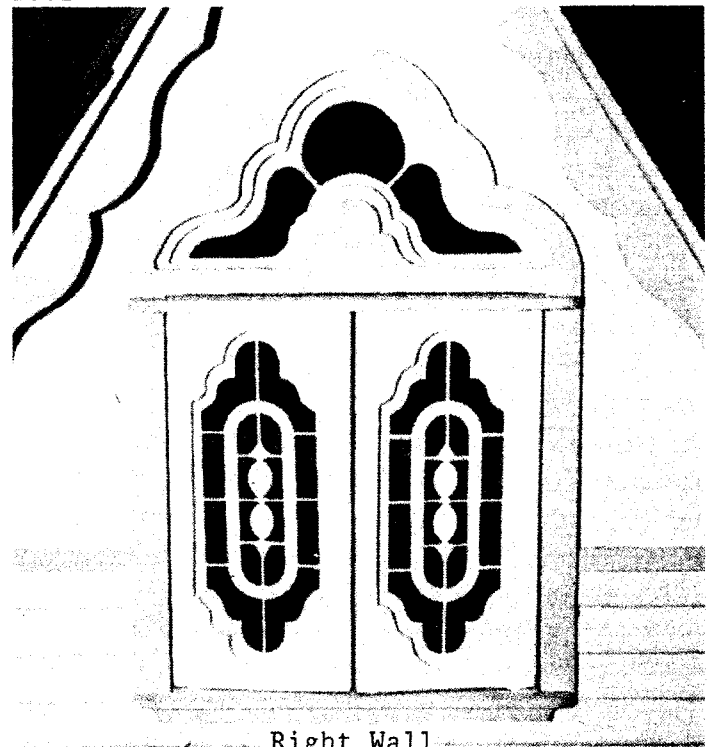

Right Wall
Double Swinging Windows

Figure 29

BALCONY RAIL

1. Cut to fit the small tower corner post molding (Part No. S5-76) trim the porch roof as in the front view.

2. From the small corner post molding (Part No. S5-2), cut two $1\frac{15}{16}$ " lengths.

3. Locate the front, left and right balcony rails (Sheets AL-2,6).

4. Glue the small corner post lengths centered on the ends of the balcony rails. Cut small edge trim to cap both the top and bottom of the banister rails. Figure 30.

5. Glue to top of porch roof.

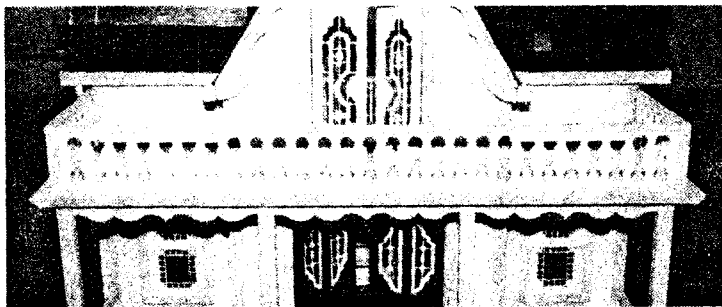
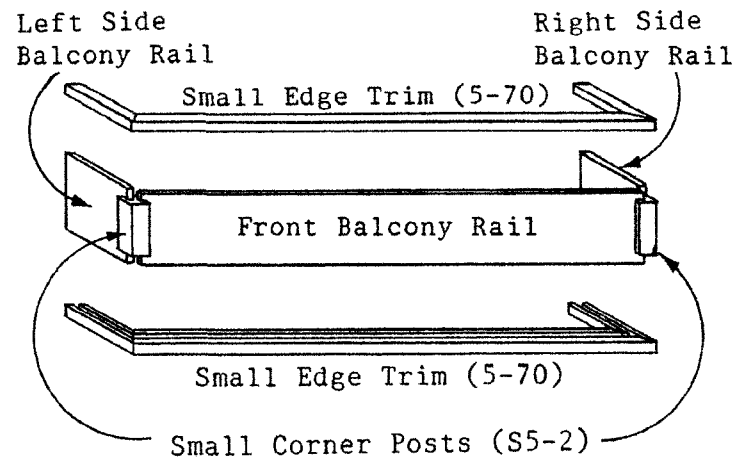

Figure 30

ROOFS

1. Locate back roof, front roof, left front gable roof, and right front gable roof (Sheets AL-5,6,7).

2. Lay all roof parts on the table facing up. Starting at the bottom of the roof parts make marks every $\frac{7}{8}$ " starting 1" from the bottom. Figure 31.

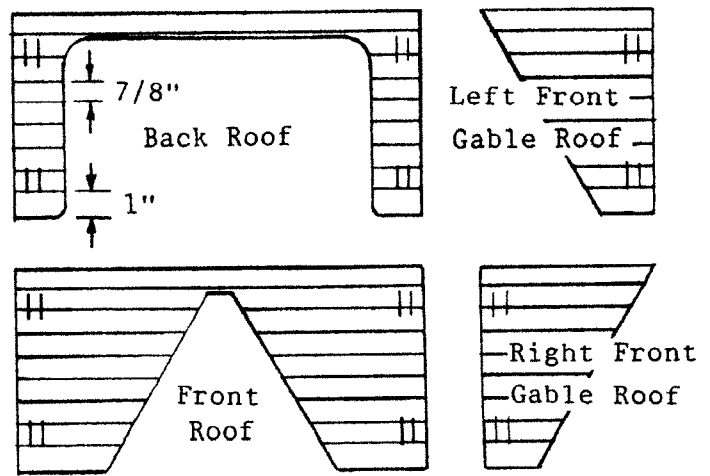

Figure 31

3. Draw lines across the roof parts parallel to the bottoms.

4. Glue the back roof to the back of the gables by running a bead of glue along the gable and placing back roof on gable so the gable tabs insert into inner back roof slots.

5. Continue to the front roof using the same method. Interlock and glue together the tops of the front roof and back roof.

6. Use the same method with the front gable roofs. Interlock the notches on the diagonal edges of the front gable roofs with the front roof opening notches.

7. Locate the front, right, and left 1 and 2 gable decorations (Sheets AL-9,10).

8. Glue gable decorations into outer roof slots. The flat spots on the ends of the left and right gable decoration parts go to the front of the house for the gutters to glue to.

9. Glue Chimney and Fireplace in place. See Back View and Left Side View.

REDWOOD SHAKES

1. Glue the shakes on the roof starting from the bottom and working up. Align the top edges of each row of shakes with the lines you drew earlier. The rows should be staggered so that each shake covers a portion of the two shakes below.

2. Cut the shakes to the appropriate angles where needed with a sharp knife.
3. Add a row of horizontal shakes for ridge cap. See front view.
4. Add redwood trim (Part No. 5-19) to the edges of the gables.

GUTTERS

1. Cut the gutters (Part No. 5-142) to fit the bottom of the roof edges. Glue the gutters to the underside of the shakes.
2. Add downspout (Part No. 5-143) to the gutter. Figure 32.

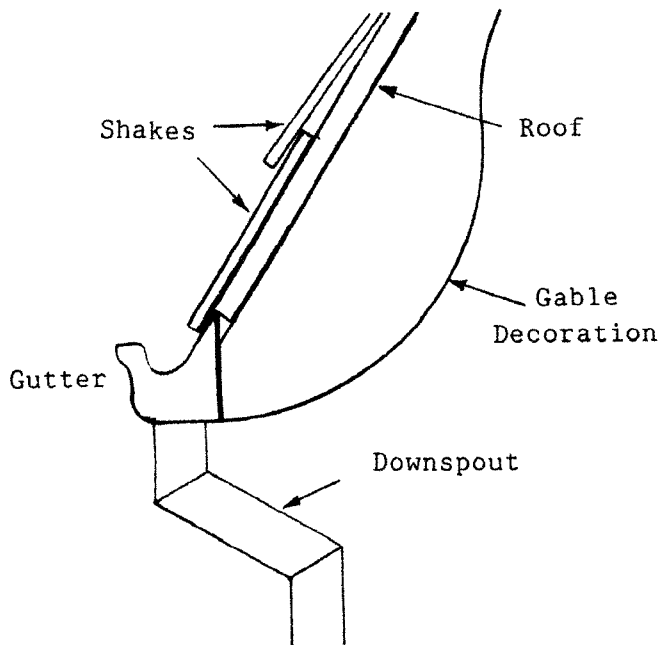

Figure 32

TRIM

1. Using the universal trim (Part No. 5-3), the inside and outside base/wall junctions, the 2nd floor/wall junctions, the top of the base bricks, the inside and outside gable/wall junctions, and the wall/roof junctions. See front, back and side views.

FRONT STEPS

1. Locate the front step parts (Sheet No. AL-1). Assemble as in Figure 33.
2. Glue to the base step opening.

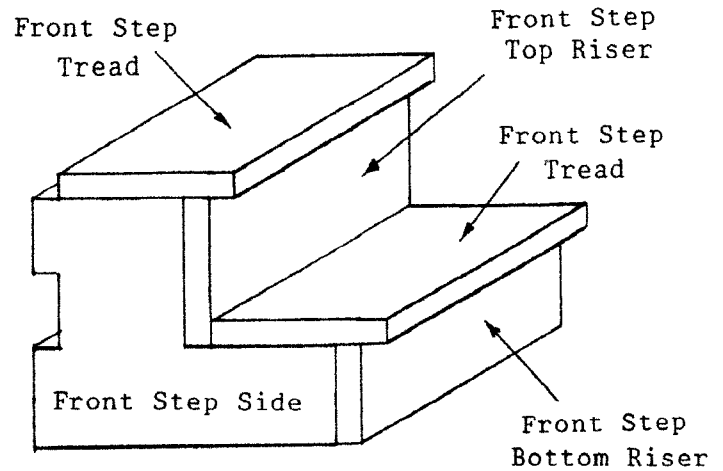
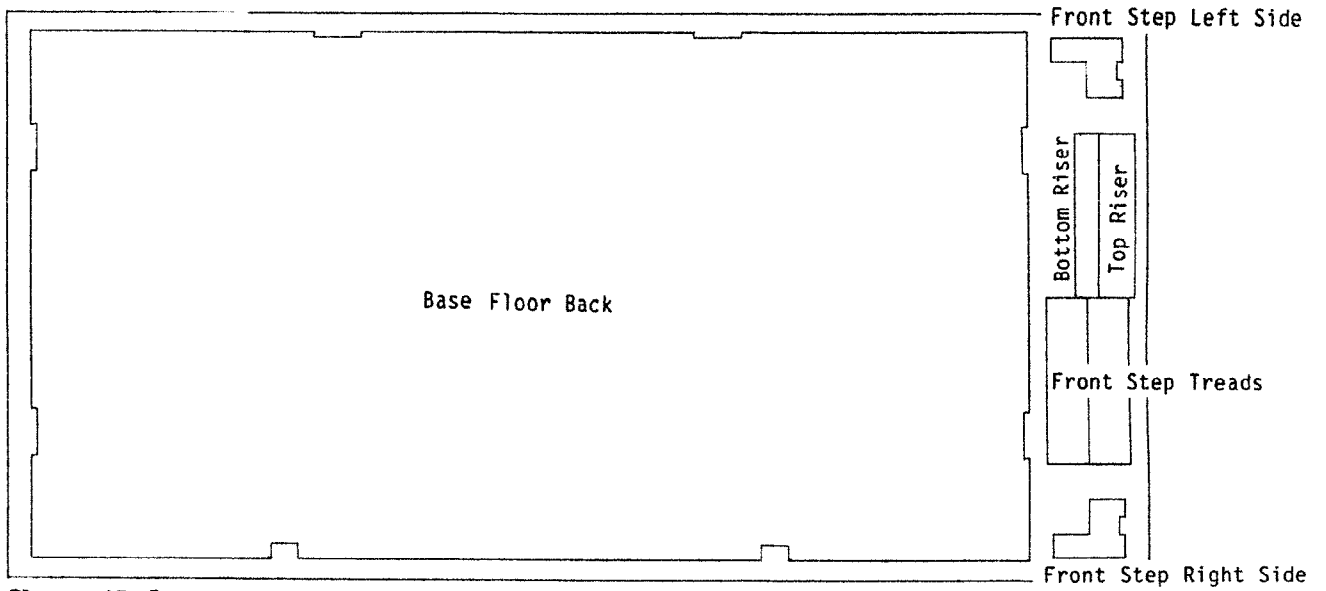

Figure 33

Congratulations! You have completed your miniature house. We know you will have many hours of fun decorating it, playing with it, and showing it off to your friends. If we at Dura-Craft, Inc. can be of any further assistance, please feel free to contact us.

EACH PART IS HELD IN THE BOARD BY NOTCHES, THESE NOTCHES
MUST BE CUT BEFORE REMOVING PARTS FROM THE BOARDS.



Sheet AL-1

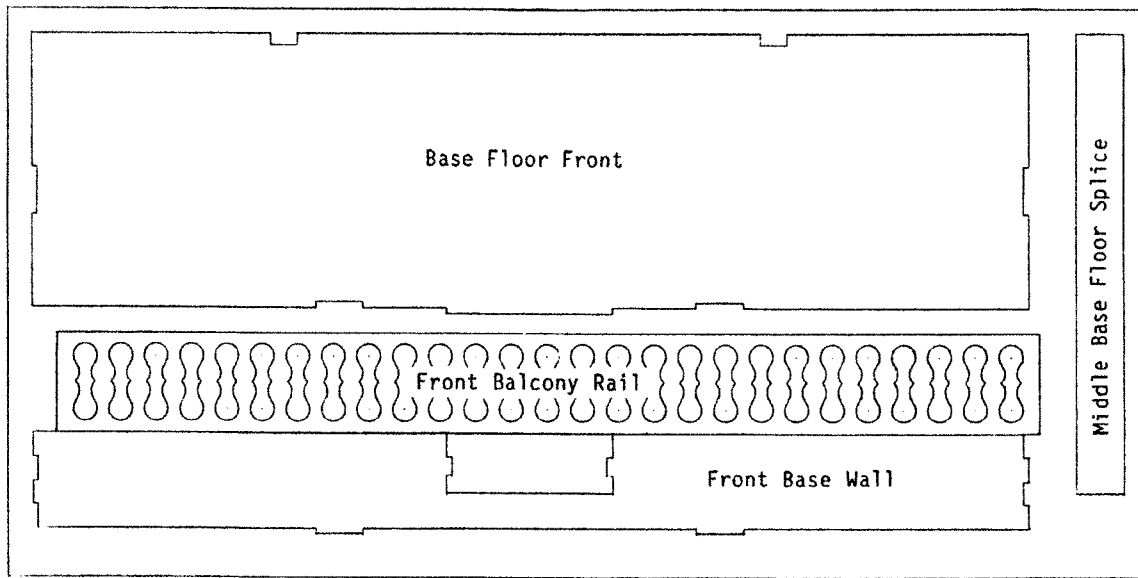

Sheet AL-2

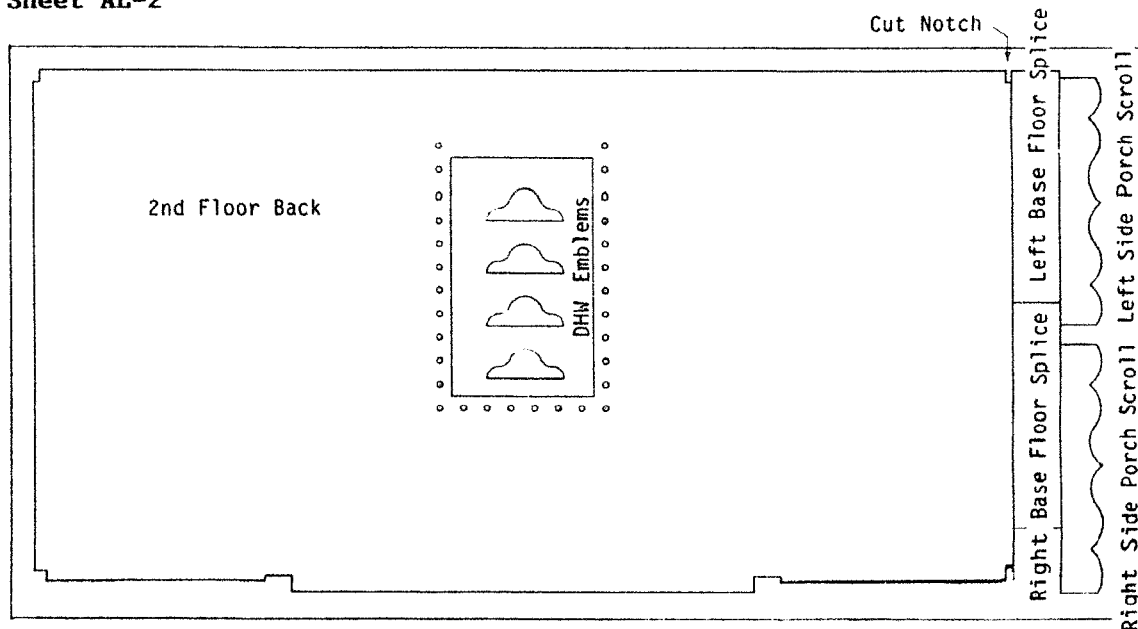

Sheet AL-3

EACH PART IS HELD IN THE BOARD BY NOTCHES, THESE NOTCHES
MUST BE CUT BEFORE REMOVING PARTS FROM THE BOARDS.

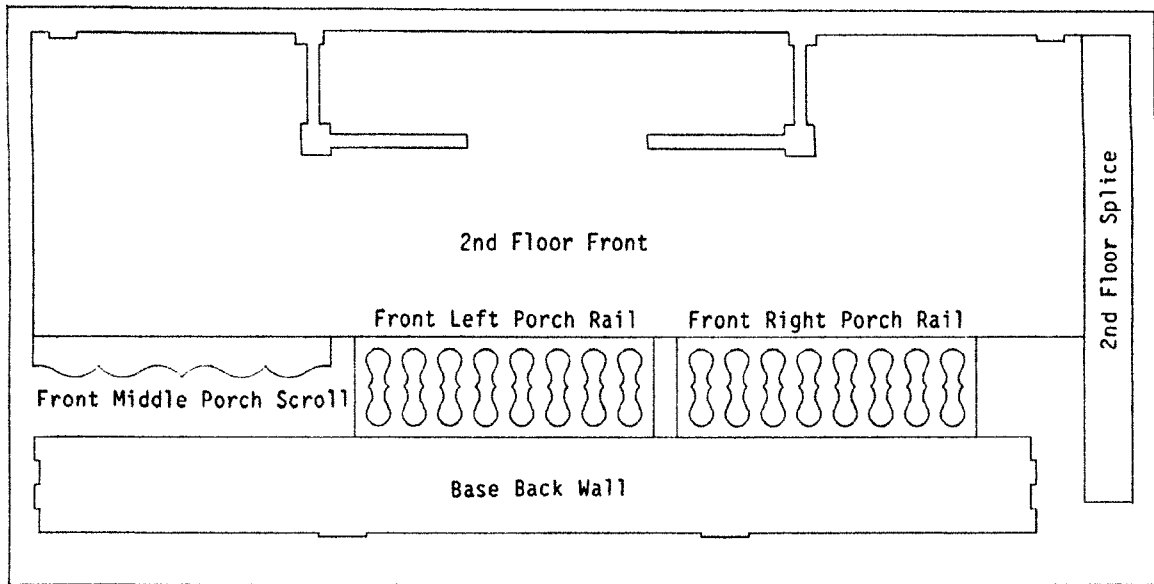

Sheet AL-4

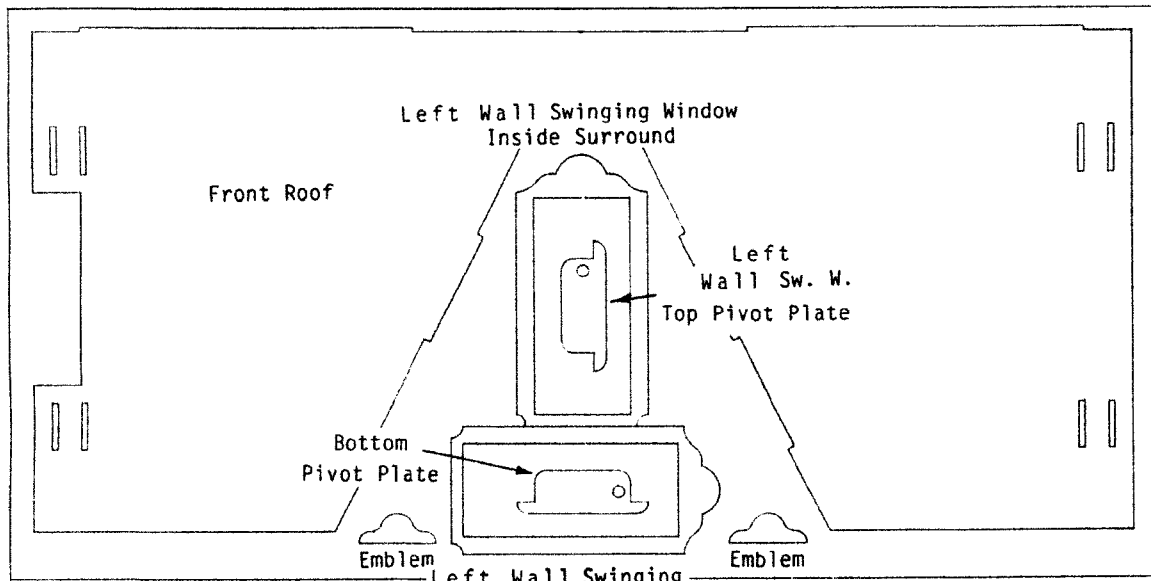

Sheet AL-5

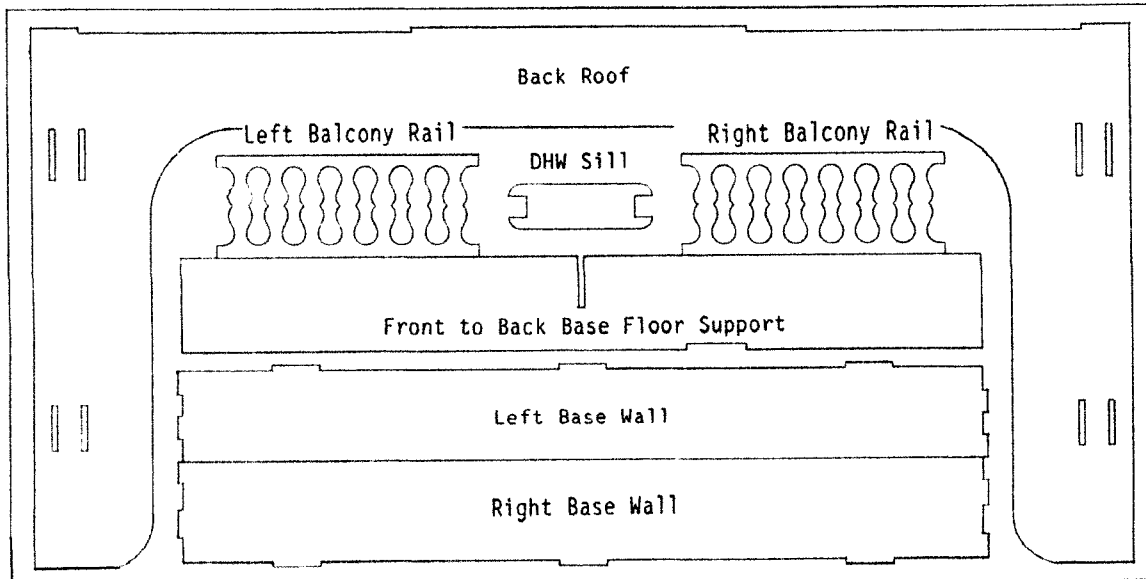

Sheet AL-6

EACH PART IS HELD IN THE BOARD BY NOTCHES, THESE NOTCHES MUST BE CUT BEFORE REMOVING PARTS FROM THE BOARDS.

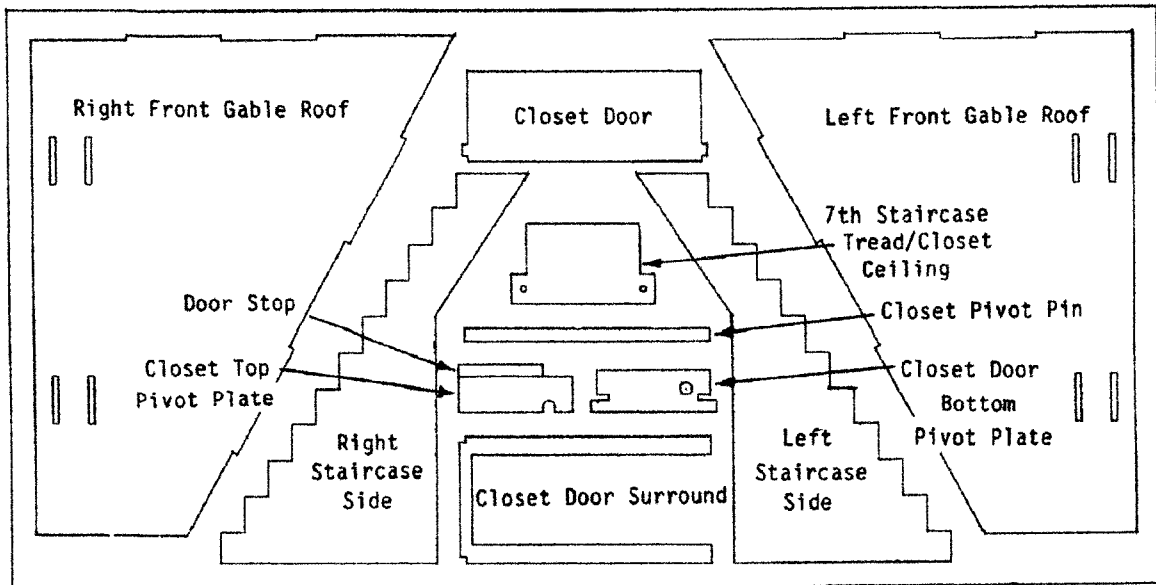

Sheet AL-7

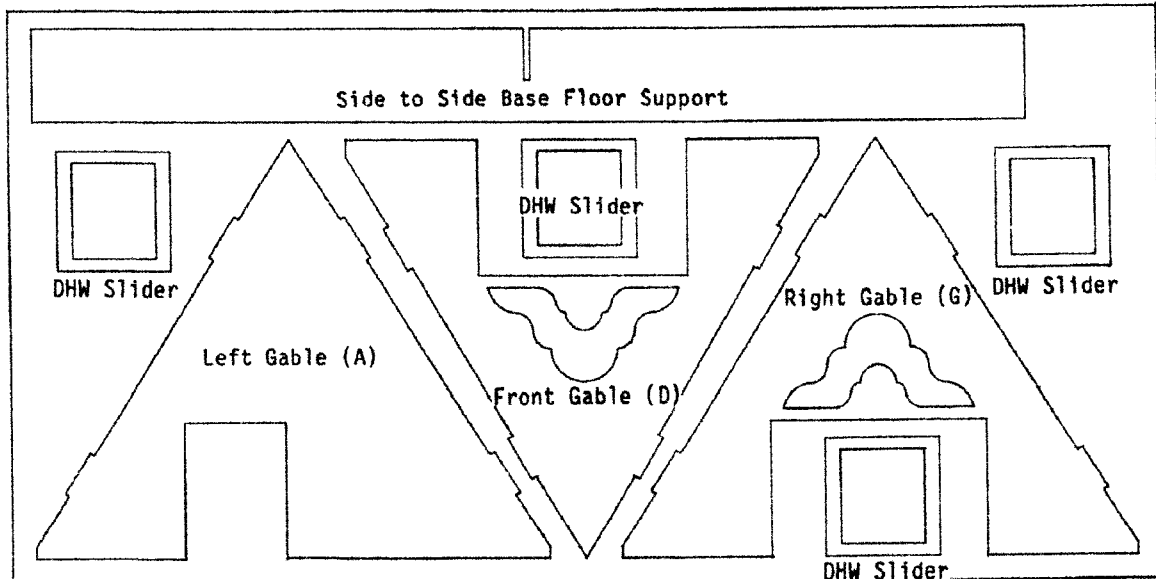

Sheet AL-8

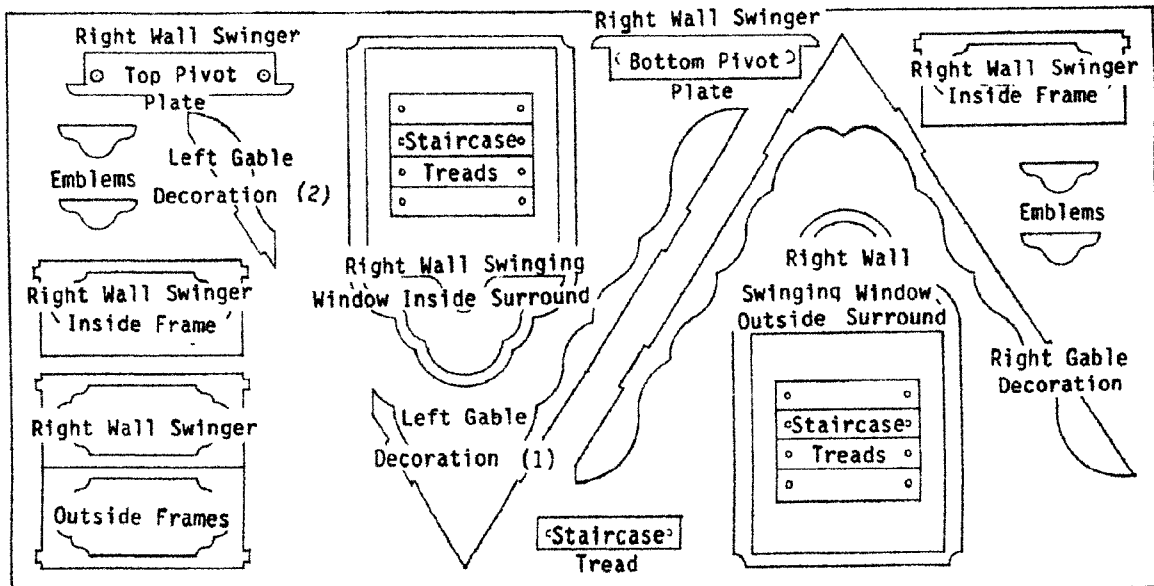

Sheet AL-9

EACH PART IS HELD IN THE BOARD BY NOTCHES, THESE NOTCHES
MUST BE CUT BEFORE REMOVING PARTS FROM THE BOARDS

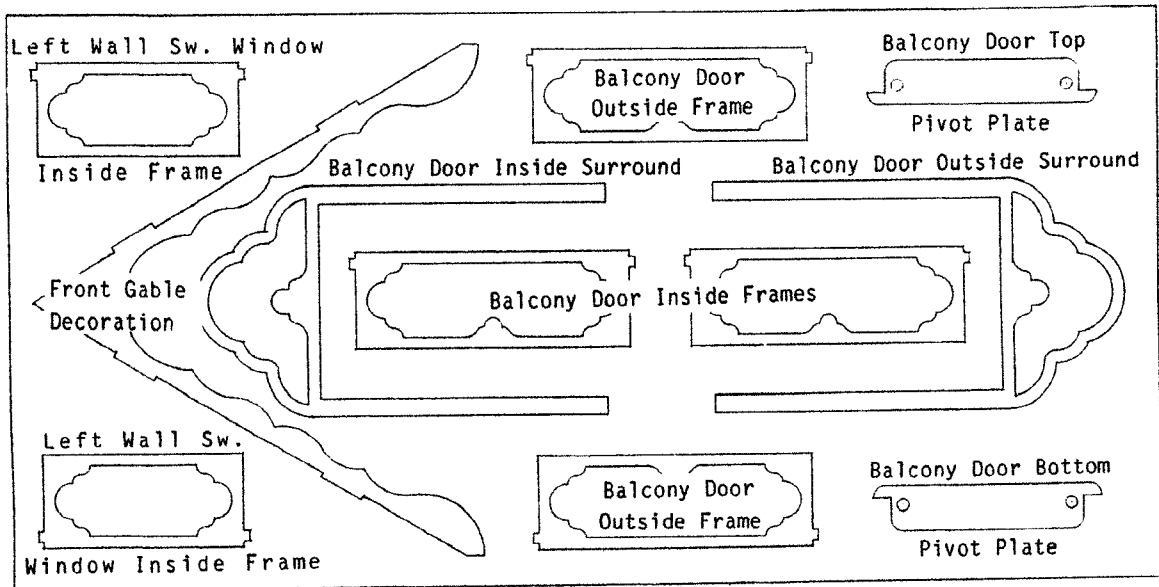

Sheet AL-10

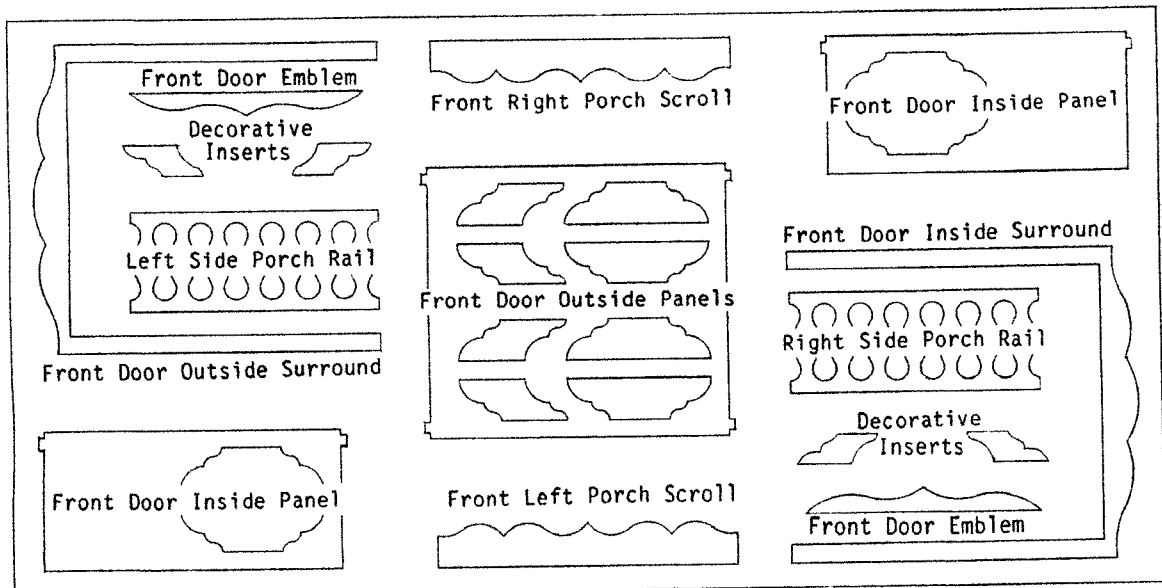

Sheet AL-11

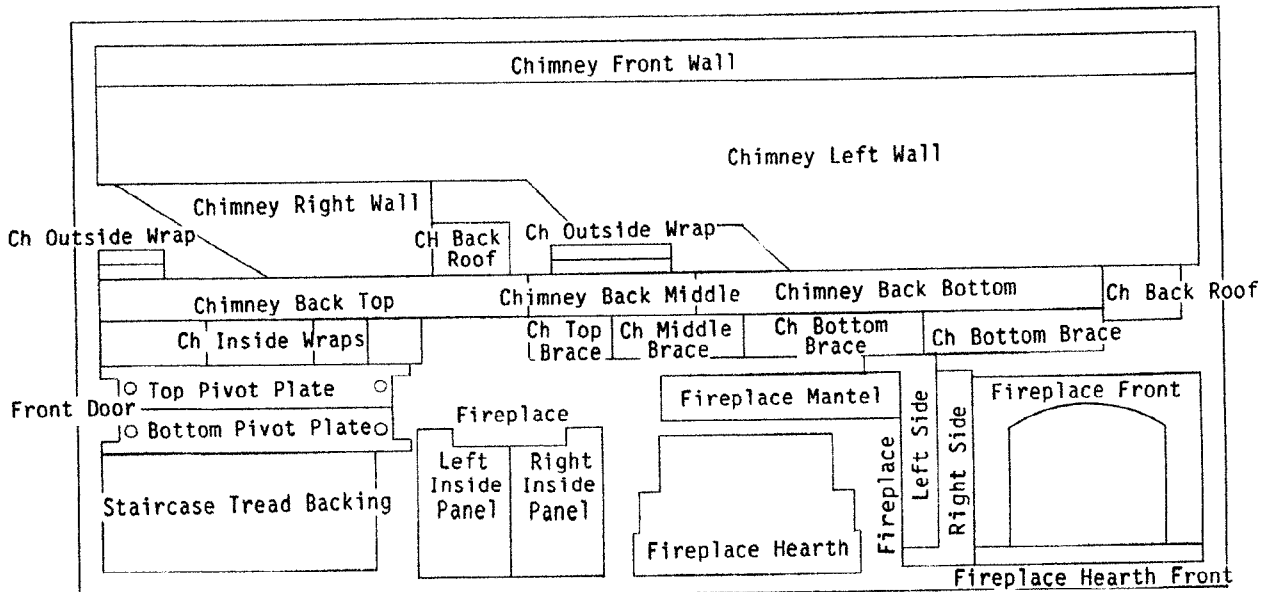

Sheet AL-12

EACH PART IS HELD IN THE BOARD BY NOTCHES, THESE NOTCHES
MUST BE CUT BEFORE REMOVING PARTS FROM THE BOARDS.

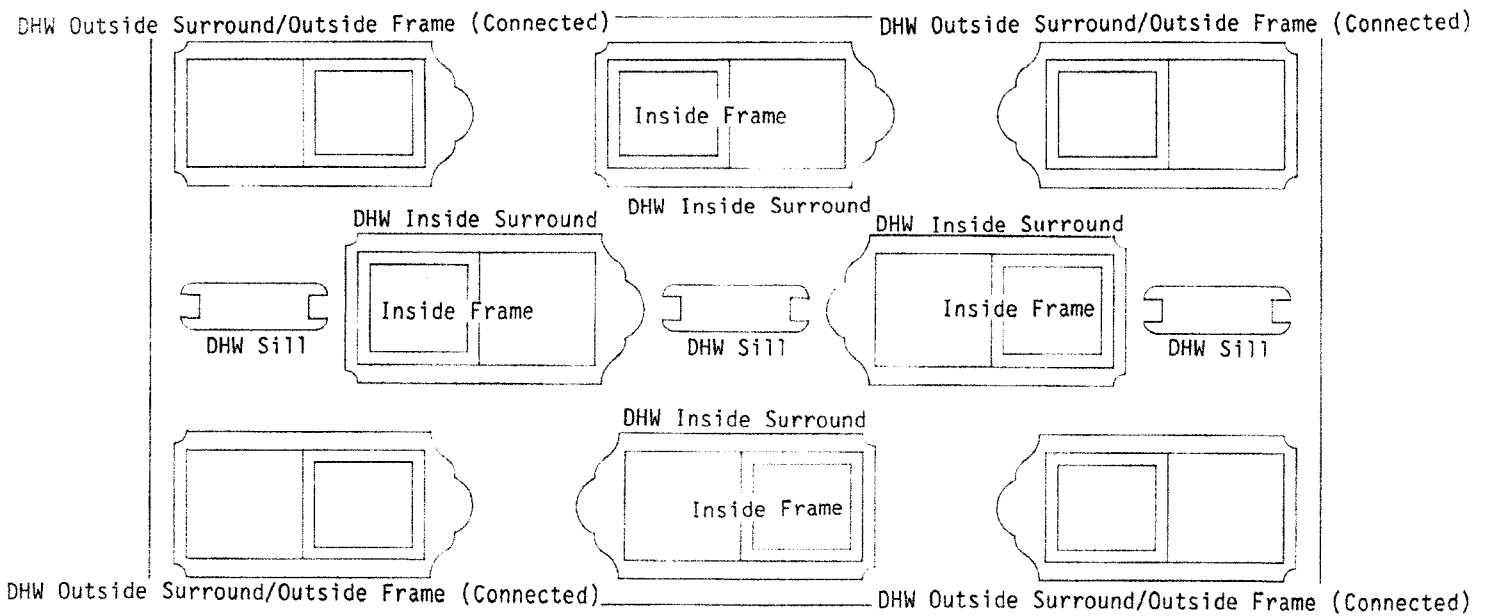

Sheet AL-13

RIGHT VIEW

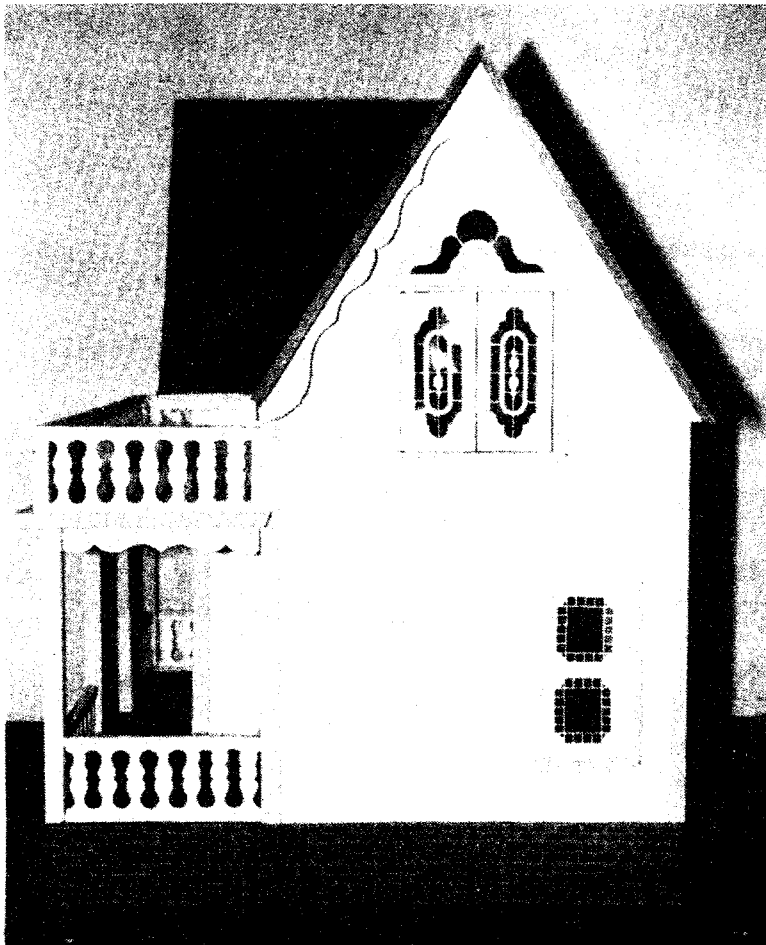

LEFT VIEW

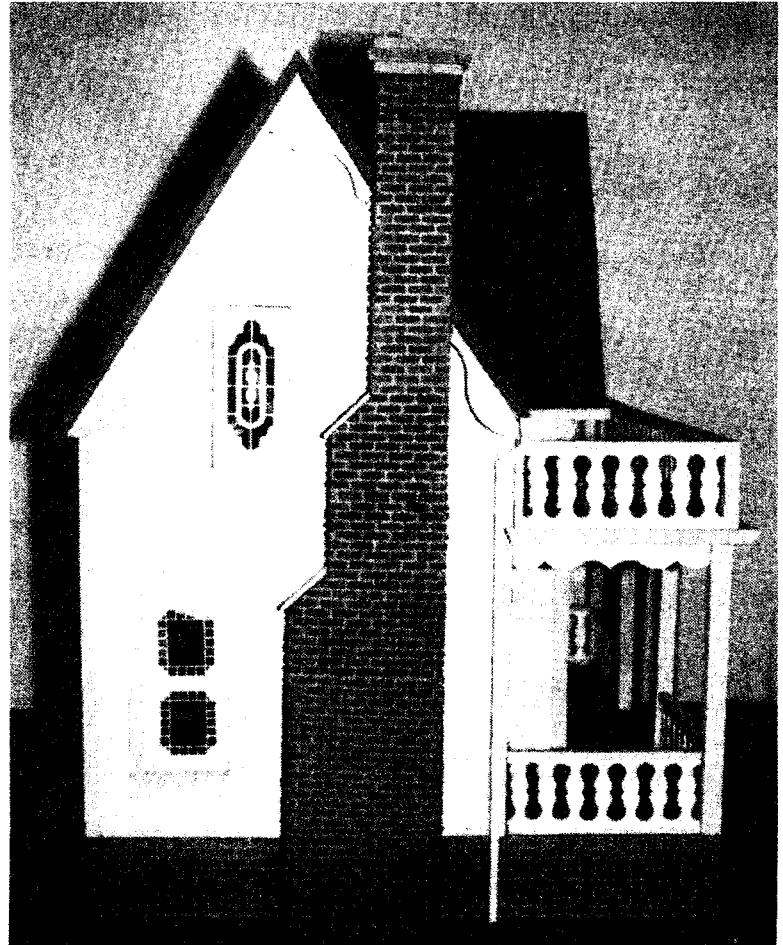

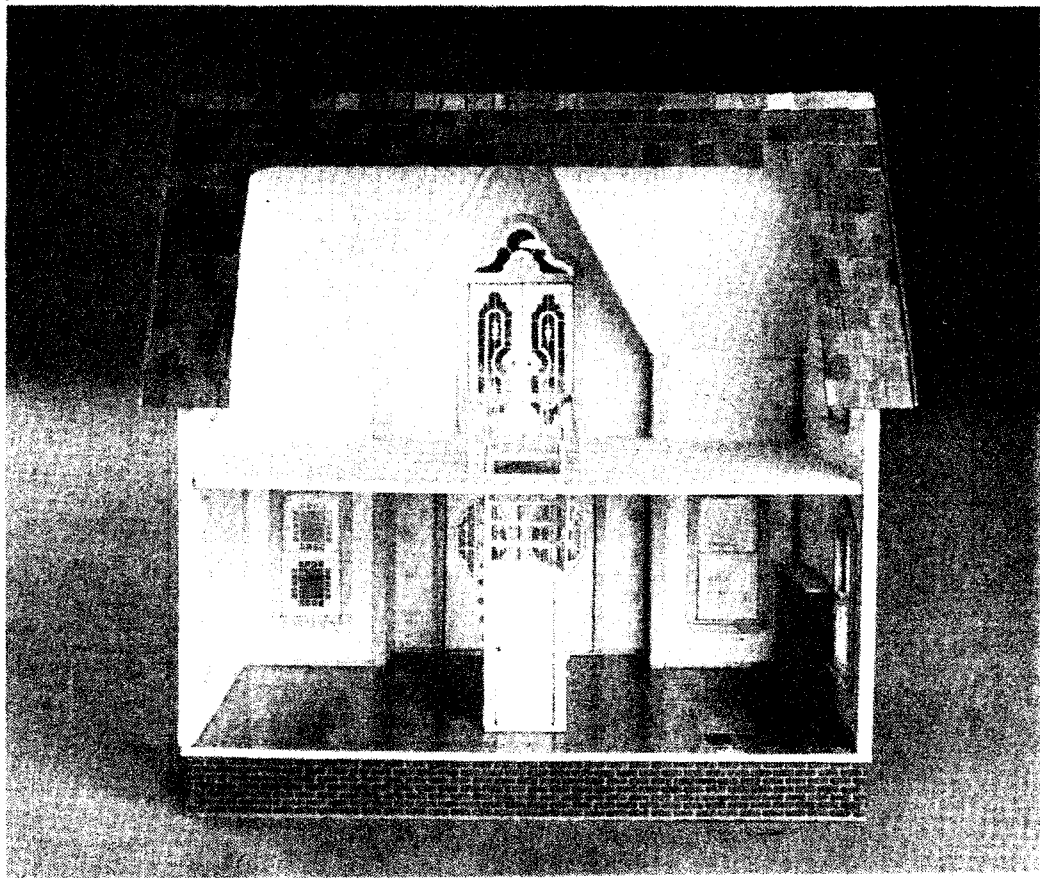

WARRANTY

Buy this kit with confidence!

Dura-Craft, Inc. will guarantee each purchase with the necessary service and assistance to satisfactorily complete this kit. Damaged or missing parts will be replaced even if the damage is caused by improper assembly. This assistance will be supplied at no additional cost.

Dura-Craft, Inc.
P.O. Box 438
Newberg, OR 97132
(503) 538-3136