

SF 555 San Franciscan

MINIATURE HOUSE KIT ASSEMBLY INSTRUCTIONS

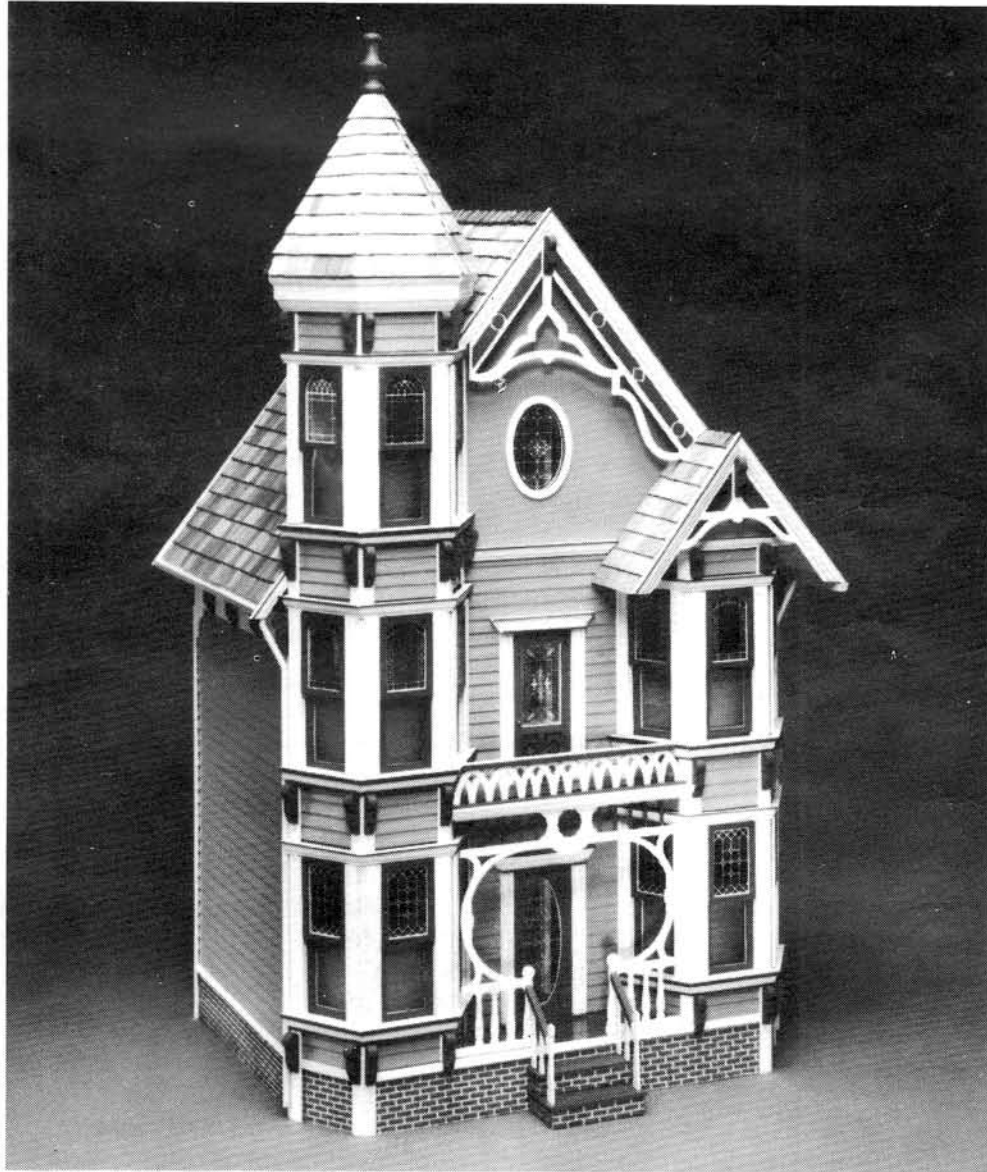

FINISHED SIZE: 43"H x 24"W x 20"D

SCALE: 1"=1

P.O. Box 438
Newberg, OR 97132

Dura-Craft, Inc.

(503) 538-3136
Rev. 6/10/94

COPYRIGHT 1994

PATENTS PENDING

SAN FRANCISCAN

SF 555 MINIATURE HOUSE KIT

Assembly Instructions

Congratulations on selecting a miniature house kit manufactured by Dura-Craft, Inc., the leader in the industry. We pride ourselves in our high quality and workmanship. Each piece is graded and sorted at several different stages to ensure that you receive the finest quality.

A Dura-Craft miniature house is a complete kit. You will not have to make separate purchases of items like the windows and shingles which are a basic part of your house.

If ample time and care are used in construction and finishing, your house will be of heirloom quality, of which you will be justly proud.

NOTE: For shortages or broken parts write directly to Dura-Craft, Inc. for replacement, using the form on the last page of this manual.

READ BEFORE STARTING ASSEMBLY:

The following tips will help you avoid problems when you build your miniature house.

1. **Save The Box** - The photo will be very helpful during assembly.
2. **Read Instructions First** - Before beginning construction of your miniature, read through all instructions to get a feel for the assembly process and to gain familiarity with the parts.
3. **Follow Instructions In Order**
4. **Don't Force Pieces** - If you cannot release a part from its board with moderate pressure, carefully cut it loose with a utility knife. Always cut from the good side of the board where the cut lines are clearly visible.
5. **We Will Replace Parts** - If any parts are missing or damaged, Dura-Craft, Inc. will quickly replace them at your request. Please write or call and give us the name and sheet number of the part or parts that you need. We have included a "Missing and Broken Parts Replacement Form" to assist you. It may save time to make missing or broken parts from scrap material.
6. **Use Tacky Glue** - This glue helps hold parts in place while it dries and it dries clear. It can be found at most craft supply stores. Any white household glue or woodworking glue may be substituted if desired. Wipe away excess glue while it is still fresh.
7. **Each Part Is Important** - Dura-Craft, Inc. has done everything

possible to ensure that your kit will look good when it is complete. We have included pine moldings to strengthen the house and trim to cover all of the outside wall and floor edges, and we have designed the kit so that slot and tab positions will be hidden when the kit is finished. However, the final quality of your house will depend to some extent on the care you take in preparing each piece for assembly. Sanding is optional, but it will improve your house. It will also remove splinters from the edges of the parts which will help the parts fit better.

8. SIDING WALLS NOT PRE-ASSEMBLED.

9. **Materials List** - You will need the following materials to assist you in the assembly of your miniature house:
 - Glue (see paragraph 6 above)
 - Utility knife or sharp, sturdy knife
 - Masking tape
 - Damp cloth or paper towels
 - Ruler or tape measure
 - Fine toothed saw such as a coping or hacksaw
 - Pencil
 - Medium and fine sandpaper
 - Wax paper
 - Several large books to use as weights
 - A framing square
 - Contact cement (oil or neoprene)
 - Steel wool (for hardwood flooring)
 - Small "C" clamps come in handy
 - Sanding sealer (oil base)
 - Paint (oil or latex)
 - Glue stick- for wallpaper and carpet
 - Large baggies

GLOSSARY:

Good Side: The side the pieces were stamped from; the smoothest side.

Bead of Glue: A line of glue approximately the size of a pencil lead.
": Inches

Flush: When the edges of two boards are even.

Left and Right Sides: All references will be made from the front view, unless otherwise instructed.

Tab: A projection off the edge of a board.

Slot: A hole in a board that a tab fits into.

Notch: The same as a slot except it's on the edge of a board.

Glass: Silkscreened plastic sheets.

Parts List:

Part No. SF Sheet-1 thru 23
23 stamped sheets of parts
(see back of instructions)

Siding

Part No. Length Quantity

1-11	2"	16 pc.
1-4	3"	49 pc.
1-31	7"	4 pc.
1-2	14"	24 pc.

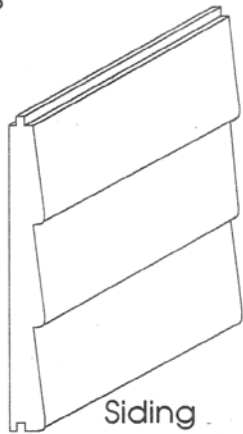

Siding

Part No. 5-141
36"

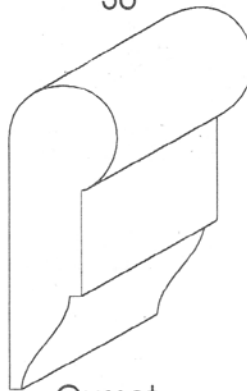

Gusset Longframe

Part No. 5-141
46 pc.



Gussets

Part No. 6-2
11 pc.



Small Dowels

Part No. 5-100
Longframe
61"

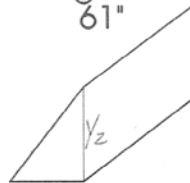

Fillet Molding

Part No. 5-46
130"

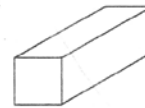

1/4"x1/4"

Part No. 5-3
267"

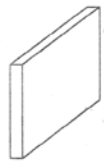

Universal Trim

Part No. 5-142
36"

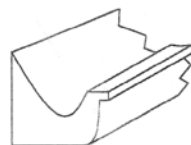

Gutters

Part No. 5-143
48"



Downspout

Part No. 5-155
332"

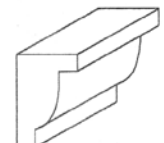

Small Bracket Longframe

Part No. 5-76
401"

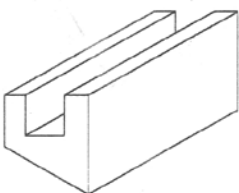

Large Tower Corner Post

Part No. S5-76
24"

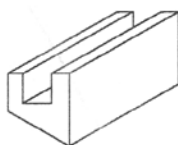

Small Tower Corner Post

Part No. 5-2
46"

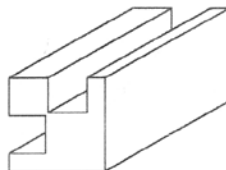

Large Corner Post

Part No. S5-2
49"

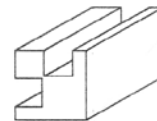

Small Corner Post

Part No. 6-19
1 bundle



Hardwood Flooring

Part No. 5-1
88"

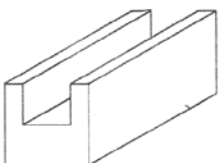

Large Edge Trim

Part No. 6-4
24"

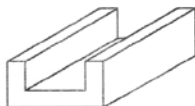

Balcony Railing Trim

Part No. 5-70
84"

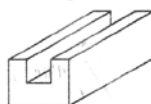

Small Edge Trim

Part No. 5-156
192"

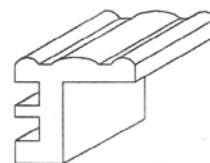

Moving Window Molding

Part No. 5-157
26"

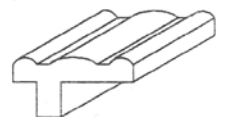

Door Molding

SF555 Window Glass

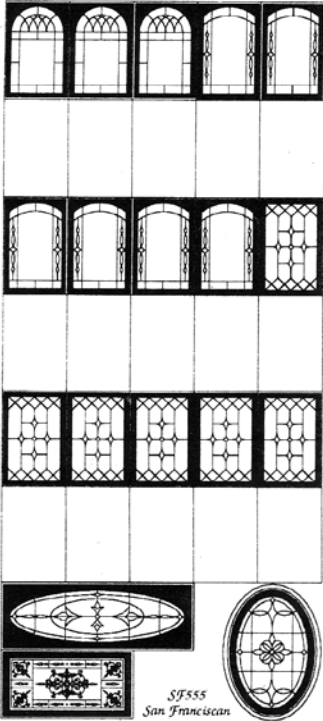

LONGFRAME PRE-CUT LIST ("LPL")

Other Longframe parts will be cut-to-fit

(Cut these parts from the moldings with the **Miter Box** provided)**

Section	Part #	Used for	Qty.	Length
Floor Supports	5-46	Wall A & I	4 pc.	13 1/2"
	5-46	Wall E	3 pc.	6 1/2"
	5-46	Large Gable	1 pc.	6 1/2"
2nd, 3rd, 4th Floors	5-100	3rd Floor	1 pc.	3"
	5-100	3rd Floor	1 pc.	12 1/4"
	5-100	3rd Floor	1 pc.	17"
	5-100	4th Floor	2 pc.	13 1/2"
Walls and Windows	5-2	Back edges of Walls A,I	2 pc.	23"
	5-76*	Tower	4 pc.	34 1/4"
	5-76*	Tower	2 pc.	31 13/16"
	5-76*	Bay	4 pc.	21 13/16"
	5-76*	Bay	2 pc.	19 3/8"
	5-1*	Walls A, E, and I	4 pc.	21 13/16"
	5-156	Windows	30 pc.	6 1/4"
	5-46	Walls B2, C2, D2, F2, G2, H2, B3, C3, D3, F3, G3, H3	12 pc.	2 1/2"
	5-46	Walls D2 & F2	2 pc.	2"
	S5-2	2nd & 3rd Floor back edge	2 pc.	20 1/4"
	5-155	Tops & Bottoms of Windows	30 pc.	Figure
Door Assembly	5-157	1st & 2nd Story Doors	4 pc.	6 1/8"
	5-3	1st, 2nd Story Door Trim	4 pc.	6 3/8"
	5-155	1st, 2nd Story Door In. Tops	2 pc.	Figure
	5-155	1st, 2nd Door Out. Tops	2 pc.	Figure
	5-70	Vertical Doorway Trim	3 pc.	6 1/8"
Room Partitions	5-155	Non-Stair Side Door Tops	4 pc.	3 1/4"
	5-155	Stair Side Door Tops	2 pc.	Figure
	5-76*	Walls J, K, L	6 pc.	12 5/16"
Roofs and Gables	5-141	Top of Tower	6 pc.	Figure
	6-4	Bottom of Balcony Rail	1 pc.	Figure
Gingerbread	6-4	Top of Balcony Rail	1 pc.	Figure
	S5-76	Front of Balcony Floor	1 pc.	Figure
	5-70	Bottom of Porch Rail	1 pc.	Figure
	5-70	Bottom of Porch Rail	1 pc.	Figure

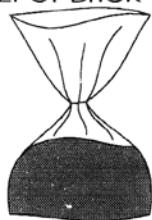
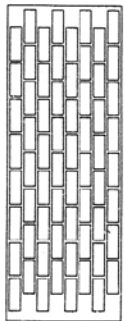
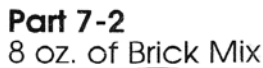
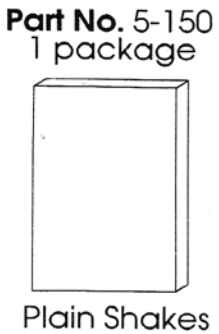
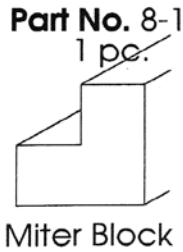
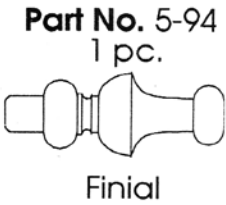

SF 555 4

*= needed for "Special Longframe Assemblies"

**= Use diagram on page 23 and 7" L shaped block in kit.

SPECIAL LONGFRAME ASSEMBLIES:

The following are longframe assemblies to be glued together before painting. See Figure 1.

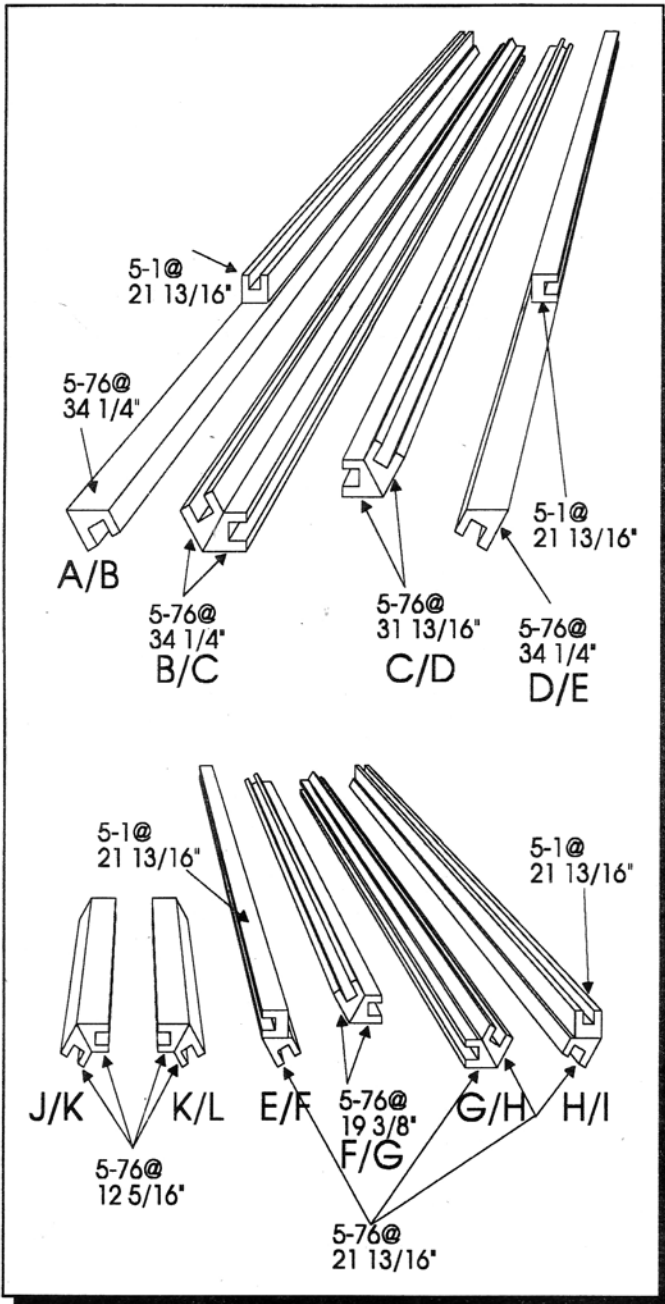

Figure 1

WALL PANELS:

The wall panels do not come assembled in the kit.

An important thing to keep in mind about the kit parts is that they are made of wood. Wood shrinks and expands according to humidity. We have found that the siding is most sensitive to dimension changes. The siding used in Dura-Craft, Inc. miniature houses is made from the finest kiln dried Ponderosa Pine. However, as a result of humidity and assembly with a water based glue, some swelling will occur, causing slight dimension changes.

1. Locate all siding parts. Measure each siding piece to be sure the parts are not longer than they are supposed to be. If they are, then cut or sand the part to the proper length.
2. Prepare an area for gluing. You will need a hard, flat surface such as a table top. Select a location where the wall panels will not have to be disturbed for several hours after gluing. Tape waxed paper over the entire surface.
3. Glue the pieces together, flat side down, as shown in Fig. 2. The tongue is on the top edge of each board.

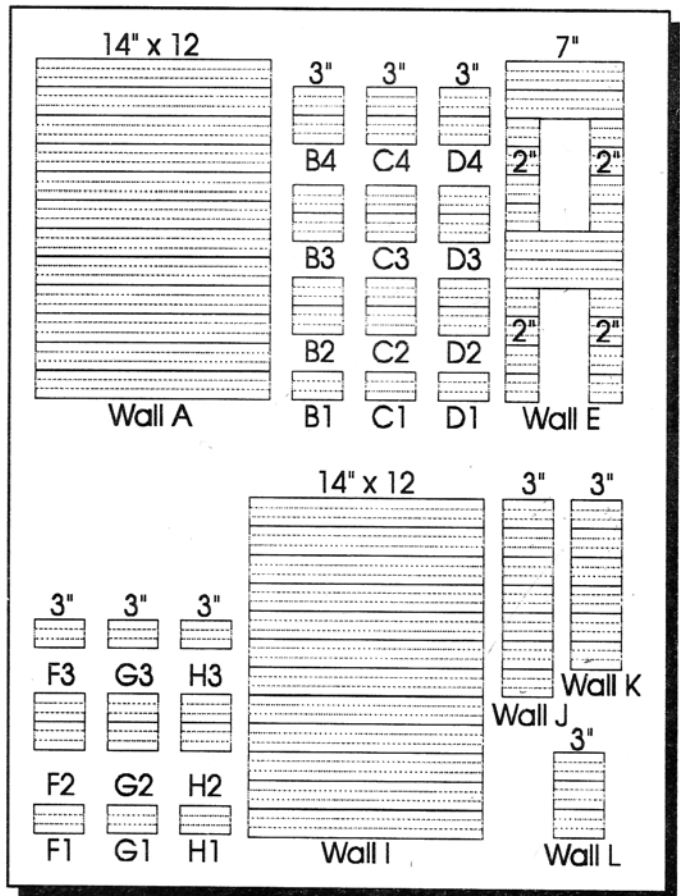

Figure 2

4. Use a framing square to insure that the ends of the siding pieces are properly aligned and square.

5. Use the following technique for gluing the wall panels: Apply a thin bead of glue to the tongue then seat it in the groove. Immediately wipe off any surplus glue that squeezes out, using a damp-but not wet-cloth. Assemble the panels flat side down on the waxed paper. Make sure that all parts are arranged in the correct sequence. **It is very important** to make sure the outer edges of the walls are flush. If you don't have a square use a table corner.

6. Make sure that all joints are tight, and that edges of the walls are square and flush. Place weights on the panels as you finish them. Allow about an hour for the glue to set before moving or adding to the panels.

7. When wall panels are complete and have set for about an hour, stand them on edge to allow air to reach both sides. Let wall panels dry in a warm, dry place for at least 24 hours, preferably 48 hours. Complete drying should prevent the walls from cracking. (If the wall panels should crack after assembly, then simply fill the cracks with glue or a wood filler, then paint.)

8. Seal the walls with an OIL BASED sealer (Sanding Sealer). This will protect the walls from absorbing moisture from the air and swelling, then shrinking and cracking.

FLOOR SUPPORTS:

1. After walls are dry, lay the assembled walls flat side up on your working surface and the Large Gable (SF Sheet- 20) good side down.

2. On Siding Walls A, E, and I, make marks on the insides (flat sides) of the walls 9 5/8" and 19 3/8" from the bottom edges. Draw lines parallel to the bottom edges of the walls. These lines mark where the tops of the 5-46 (1/4"x1/4") Floor Support Molding will be glued. The 2nd and 3rd story floors will be glued to the tops of these 5-46 pieces. (If the walls are too short for the 19 3/8" lines, then make those marks at 19 1/8" and glue the 5-46 so the bottom of the 5-46 is flush with the 19 1/8" lines.)

3. Mark the outside of Siding Wall E at 9 5/8" from the bottom and draw a line parallel to the bottom edge. Mark the inside (bad side) of the Large Gable at 9 5/8" from the bottom edge.

4. From the Longframe Pre-Cut List("LPL"- page 4) gather the 5-46 pieces. The 5-46 pieces are 1/2" shorter than the width of appropriate wall, except on the Large Gable where the 5-46 is to be cut flush with the slope of the gable peak.

5. Run a bead of glue on one edge of the 5-46 molding and glue to the walls with the top of the 5-46 flush with the lines you drew. Make sure there is an even distance (1/4") on either side of the

moldings and the edges of the siding walls. See Figure 3.

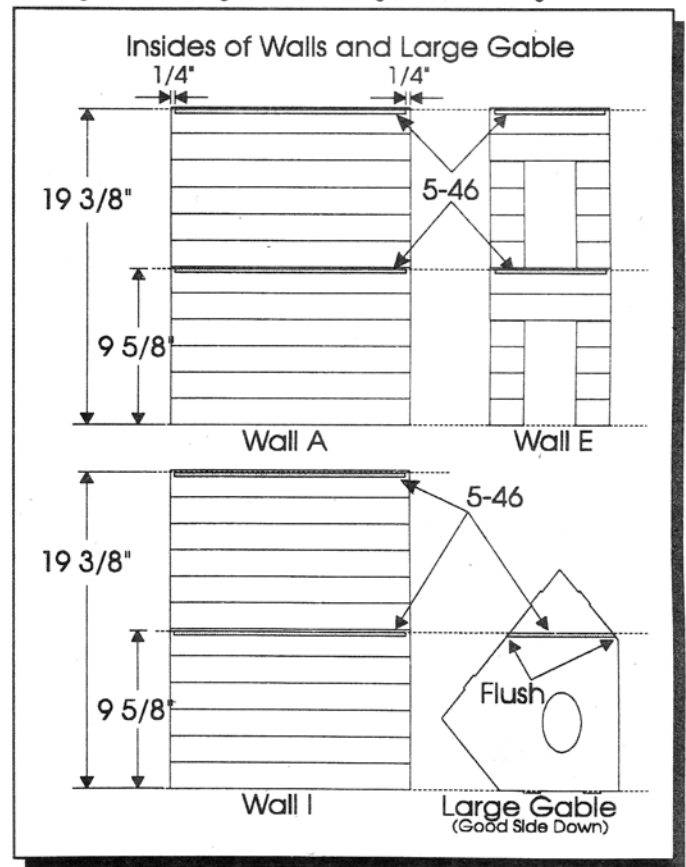

Figure 3

DIECUT PARTS:

1. This step is very helpful: Using the diagrams of the part sheets in the back of this booklet, label each individual part with a piece of masking tape. This way, after punching out all parts, you will still be able to recognize what each piece is. If you lose the tape label, you can identify it by referencing it to the diagrams provided in the back.

2. Punch each individual piece out of its sheet and group according to sub-assembly into large baggies.

3. Sand each part. Make sure that the tape labels stay with each part until the final stages of assembly.

PAINTING / STAINING

1. It is easiest and results in a higher quality paint job if parts are painted before assembly. (Except in the case of the parts to be stained such as staircases, railings and banister parts. This is because stains are oily and parts don't glue together well when oily. These parts should be stained after assembly. Make sure to wipe away all excess glue, because glue does not stain. Doors should be stained before assembly on the external surfaces, thus preventing

stain to get on the glass.)

2. Because there are so many parts, it is best to read through the entire instructions to determine which parts go where. Also use the label picture as a guide for part location. Note the windows are different on the inside than the outside. See Figure 16.

3. The house on the label was painted with at least three coats, sanding between each coat. Latex Semi-Gloss paint was used.

4. **Do not paint the surfaces of the parts that will glue together or into post grooves.** (For example: Leave 3/16" unpainted on edges of Wall Panels.)

5. Paint Longframe parts. Read and plan ahead to determine which edges to paint and which to leave bare.

WALLPAPERING:

1. The next step in the construction of your miniature is to wallpaper the walls and room partitions. Wallpapering gives a very nice finished touch to the house and adds to its uniqueness as well. Wallpapering for your miniature can be found in many craft and hobby stores. If you are not going to wallpaper, skip this section. If you are going to have electric working lights in your house, you must first assemble, then electrify and then wallpaper your house.

2. Wall E and the Large Gable are going to be split by room partitions on the 1st, 2nd, and 3rd floor creating six separate rooms. If you are going to wallpaper each room differently you must determine where the junction of the different paper types will occur. To determine this draw lines as indicated in Figure 4.

3. Now wallpaper Walls A, B1, B4, C1, C4, D1, D4, E, F1, G1, H1, I, J, K, and L, the Large and Small Gables, the 1st, 2nd and 3rd Floor Room Partitions. Walls B2, B3, C2, C3, D2, D3, F2, F3, G2, G3, H2, and H3 will need to be temporarily installed to determine the exact height of the Floor Supports on these walls. Wallpapering must be done after the Floor Supports are installed.

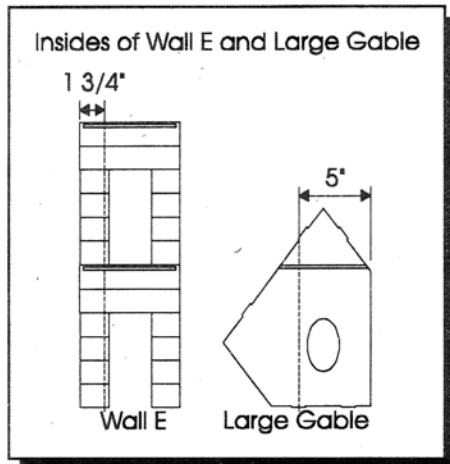

Figure 4

4. Pick a wall to paper and apply paste or glue stick to entire surface. Apply the paper to the insides of the walls. Leave approximately 3/16" bare on the edges of the Siding Walls so the walls will fit into the cornerposts. You can trim the paper to size after it dries. The 5-46 Molding (1/4" x 1/4") can either be papered or left exposed and painted to act as trim. **Do not** paper the top edge of the 5-46. Refer to the Back View photo to determine which wall to paper which pattern.

BASE:

1. Locate Base Walls A through F, Base Wall Supports, Base Floor Front and Back, Base Floor Splice (SF Sheets-1, 2, 12, 14, 18, 22, 23).

2. Tape the Base Floor Front and Back together along the junction line on the good side. Turn Base Floor assembly over so the good side is down. Glue Base Floor Splice in place with the splice centered over the junction line and equal distance from ends of splice to edges of floors as in Figure 5. Place weights on Splice until dry.

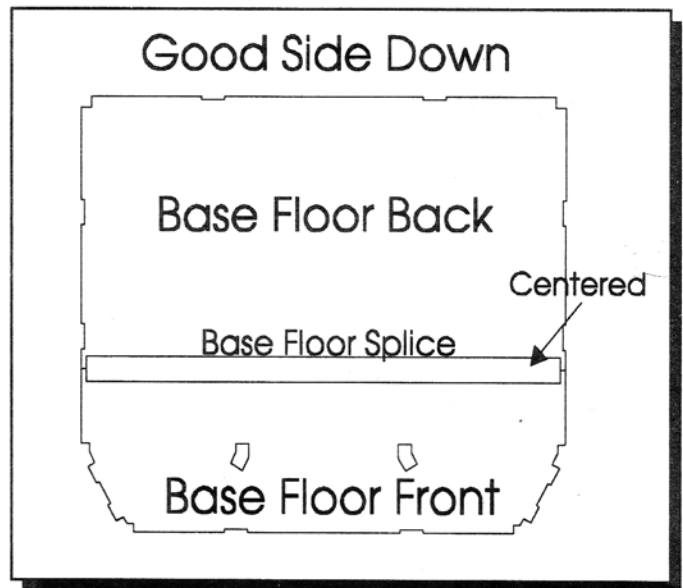

Figure 5

3. Assemble the Base upside down with a piece of tape, approximately 3" long, over each of the Base Floor notches. Tape and glue the Base Wall and Base Floor Supports in place. The Base Floor Supports need to be centered between the Base Walls A and E. Later the cornerpost assemblies D/E and E/F will protrude through the Base Floor and glue the the ends of the 7" Base Floor Support/Anchor. See Figure 6.

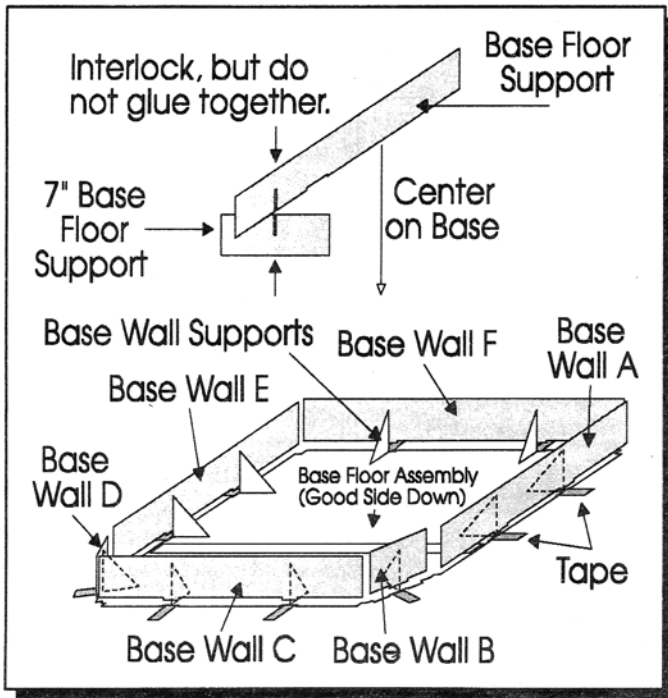

Figure 6

BRICKWORK

1. Locate all Front Step Parts except Front Step Rails (SF Sheet-19). Assemble the Front Steps as in Figure 7. Do not glue the Top Tread/Riser assembly to the Bottom assembly until bricking is completed. (Paint tops and edges of Treads before assembling.)

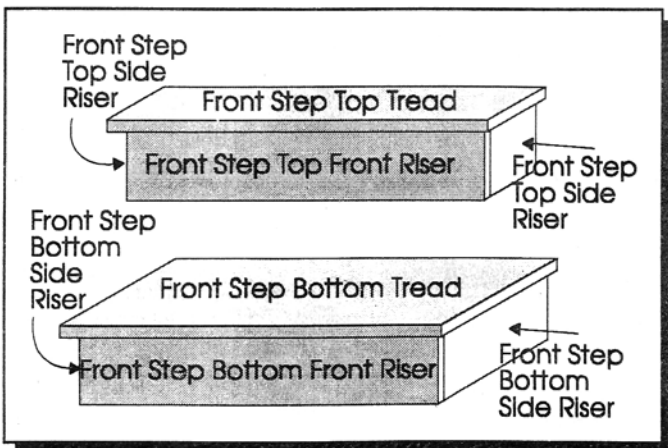

Figure 7

2. Temporarily position Front Steps centered on Base Wall C as in label photo. Trace the Front Steps onto Base Wall C. Cover the area inside the tracing with tape. Paint the Base Walls and the Front Step Risers with a latex paint. This paint will become the mortar lines between the bricks. Black, white, and grey are popular. Let dry.

3. Peel the Webbing from the Brickwork Pattern Stencil Tape as in Figure 8. Stick stencil to Base Walls and Front Step Risers leaving enough overhang to hold on to for removal. Press firmly for full contact.

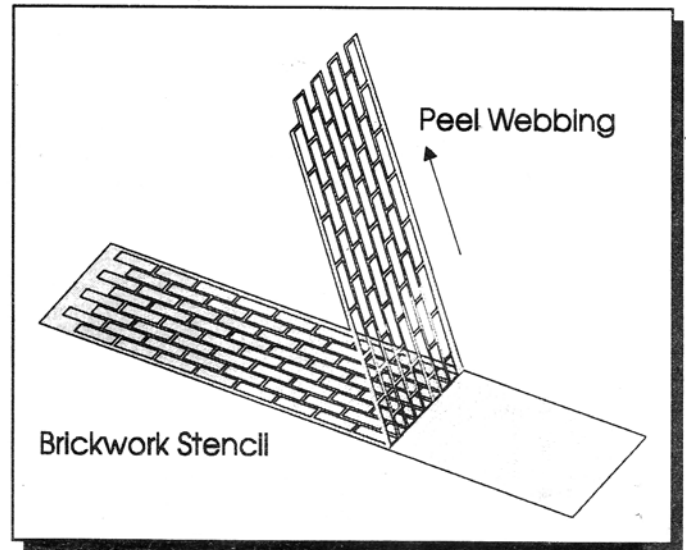

Figure 8

4. To cover 1 foot of brick template tape it takes 1 ounce or 1 1/4 tablespoons of brick powder. Put about 3 tablespoons of tacky glue (or other white glue) into a cup, add an equal amount of water to the glue. Mix well. Put the appropriate amount of brick powder for the length of surface you are going to brick into a different cup. Slowly add small amounts of glue mixture to the brick powder (It is easy to add too much glue mixture). Mix after each addition. Continue until mixture starts to hold its own shape like cake frosting.

5. Spread brick mix over webbing with a putty knife to about 1/16" thick. If you would like to paint the brick to change its color or to give it an aged look, then paint the brick now before the webbing is removed.

6. Remove webbing within 5 minutes. Stick the overhanging webbing to a piece of scrap wood and pull as you did when taking the webbing off of the backing. The wood handle will help pull the webbing off evenly.

7. Remove tape from Base Wall C. This will allow the Front Steps to be glued directly to wood.

8. If needed, touch up the bricks with a small piece of wood while the bricks are still soft.

9. After brick is dry, glue the front steps into place.

HARDWOOD FLOORING:

The hardwood flooring kit contains enough hardwood strips to cover only one floor of the house. This material may alternatively be applied to the door, stairways, or used as wall paneling, but not all. **Do not use water base glue for flooring as it will cause hardwood strips to curl.** Recommended is Naptha based contact cement (by Elmer's™) which is water clean-up and has very low fumes. If you do not plan to apply the hardwood flooring, skip this section.

WARNING: Oil based contact cement is extremely volatile and flammable. The working area must be well ventilated. Keep away from flame or sparks. We suggest using Neoprene based contact cement.

1. Brush contact cement on the base floor and on one side of the hardwood strips. Follow instructions on the contact cement.
2. Start laying hardwood strips at the back of the house and work toward the front. Cut the strips with scissors. Off-set the joints as shown in Figure 9.
3. After the hardwood strips are in place, burnish them down by rubbing them firmly with a small wood block.
4. To achieve a pegged appearance punch the ends of each strip with a 3/32" nail set as in Figure 9.

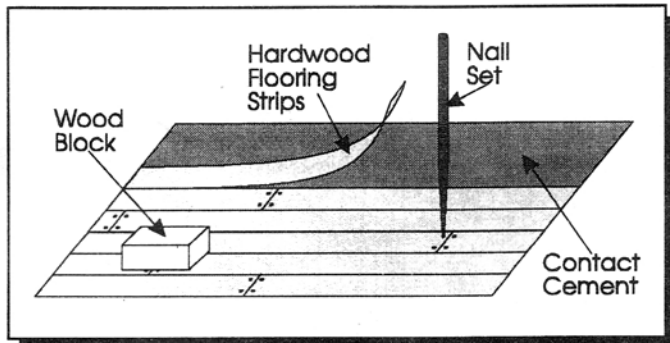

Figure 9

5. Sand the flooring smooth and remove any traces of contact cement that would interfere with the positioning of the walls on the base.
6. Using a knife, carefully cut the flooring away from covering the square hole in the floor. This is best done from the underside of the floor. Leave approximately 1/16" of flooring overhang around the floor openings. This may need to be custom trimmed when walls are installed.
7. Varnish. To prevent varnish from dripping onto brickwork, tape paper around the entire base top edge. We recommend the use of

VARATHANE™ brand, water clean-up varnish. It has low fumes and is non-toxic.

2nd, 3rd and 4th Story Floors:

1. Locate 2nd and 3rd Story Floor parts (SF Sheets- 3, 4, 5, and 6) and 5-100 molding.
2. Tape 2nd Floor Front and Back together from good side.
3. Turn 2nd Floor over so the good side is down. Glue 2nd Floor Splice in place as with the Base Floor. Be sure to center splice leaving 1/4" from the ends of splice to edges of floor. See Figure 10.

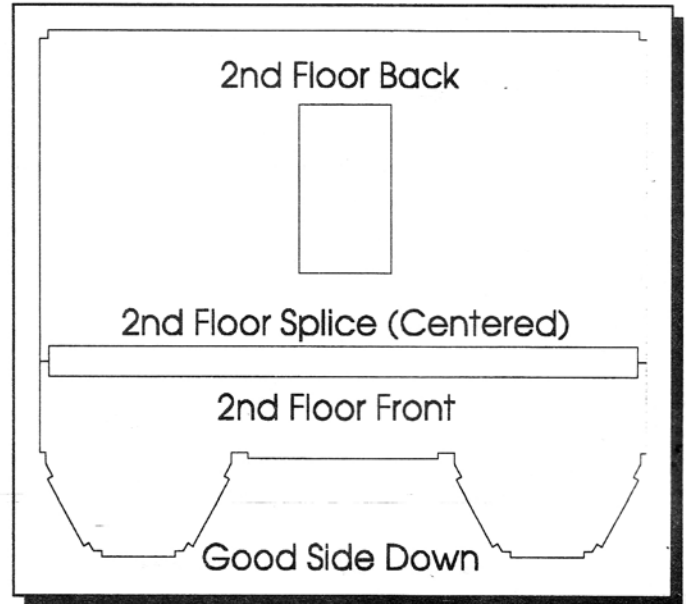

Figure 10

4. Repeat the splicing procedure for the 3rd floor parts.

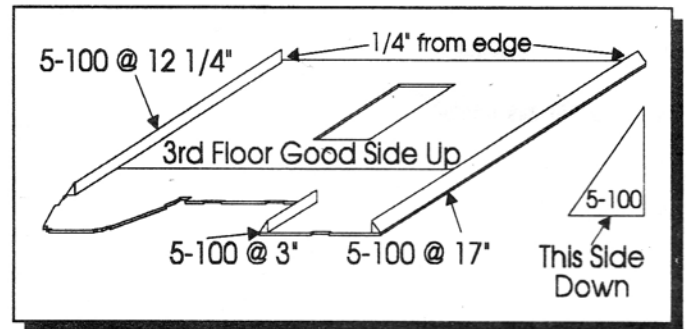

Figure 11

5. From the "LPL" gather the 3", 12 1/4" and the 17" lengths of 5-100 molding. Glue to the edges of the 3rd Floor as in Figure 11.

The shortest square edge glues to the 3rd Floor.

6. Gather the 4th Floor (SF Sheet 7), S5-2 and from the "LPL" the two 13 1/2" 5-100 moldings. Glue the 5-100s to the the longest edges of the 4th Floor as shown in Figure 12. Add S5-2 to the back edge of the 4th Floor and trim flush with the angle of the 5-100.

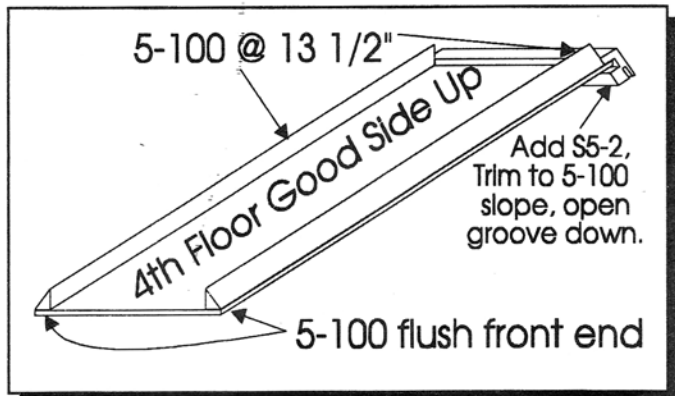

Figure 12

CARPET:

If you have decided to carpet your miniature, this would be the best time to do so. Locate the floors you would like to cover and select the fabric you wish to use as carpeting.

NOTE: Glue sticks work well. If using a spray adhesive to affix your carpeting, make sure you are in a well ventilated area.

1. Completely cover one of the floors with the adhesive.
2. Do not cut your carpeting before applying it to the floor. Lay the whole piece of fabric on the floor you are carpeting and be sure to let it hang over the edges.
3. After adhesive has dried, cut the excess amount off leaving about a 1/8" overhang. This will compensate for any gaps that may form during construction.
4. Repeat this process for all floors you wish to carpet.

WALLS AND WINDOWS:

1. From the "LPL" gather all of the parts in the Walls and Windows section including the "Special Longframe Assemblies" parts (Figure 1), the Siding Wall Panels, and the 2nd and 3rd Floors.

2. When assembling walls in Step 4, run a bead of glue in the grooves of the posts then fit walls into the grooves. Glue the bottom of the walls to the floor. Wipe off any excess glue. Fully seat walls

into grooves. It may help to lightly sand the edges of the walls to a taper and to remove burrs.

3. Temporarily lay the 2nd Floor assembly on the Base Floor. Trace the front edge of the 2nd Floor where the Siding Walls D1, E, and F1 will go. This tracing will be the inside line-up marks for Siding Walls D1, E, and F1 to assure proper wall location. Remove 2nd Floor.

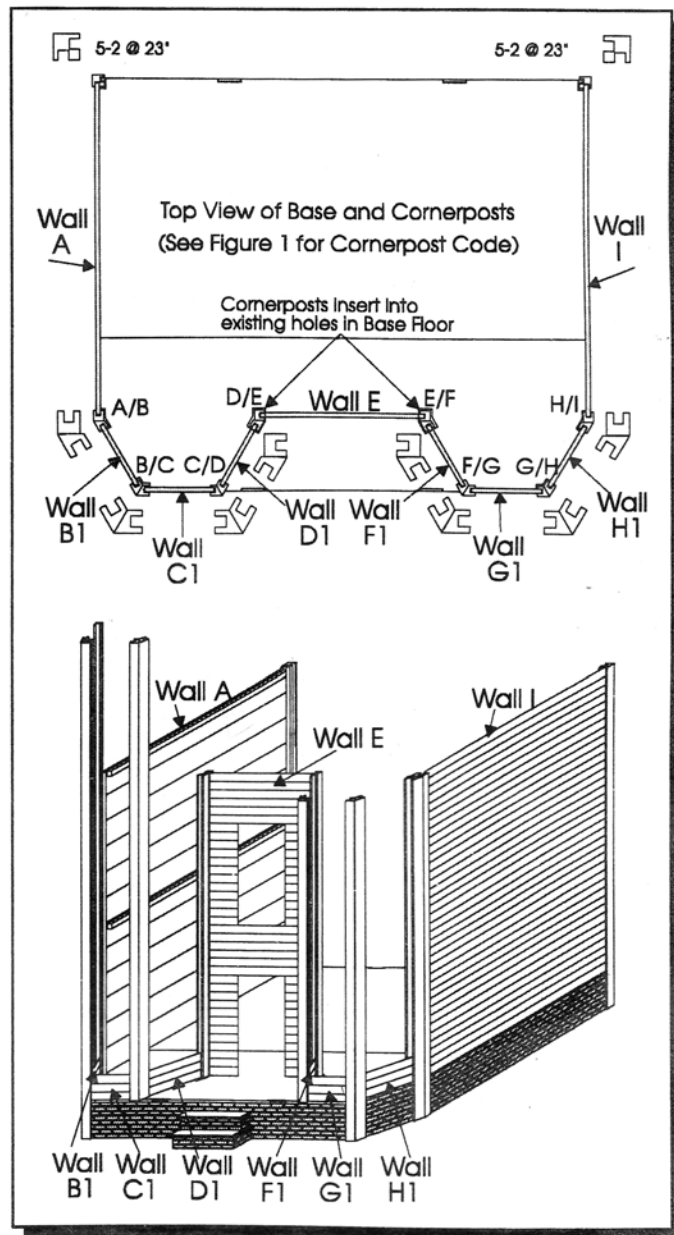

Figure 13

4. Install Siding Walls A, B1, C1, D1, E, F1, G1, H1, and I as shown in Figure 13. Trim the floor opening larger on each side of Wall E and from the notches around the base if needed.

5. The ends of the 7" Base Floor Support/Anchor glue into the grooves of the cornerposts protruding below the Base Floor. This connection anchors the walls to the base. See Figure 14.

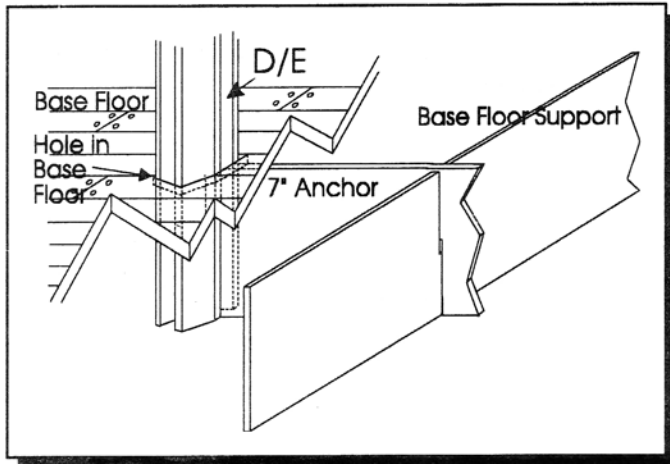

Figure 14

6. If the Siding Walls B1, C1, F1, G1 and H1 are not all the same height, then trim or add to the tops of the walls to make them so. Any alterations will be hidden by trim or wallpaper.

7. Gather all Window Frame, Slider and Window Sill parts (SF Sheets- 4,6,7,9,11,12,13,16,17,21,22,23) and window glass.

NOTE: The bottom window frames get clear glass, the top frames get glass with the silkscreen pattern. When inserting the patterned glass make sure the silkscreened side is facing the same direction as the frame which is facing out. See label photo.

8. Punch the middles out of a rectangular Slider and Frame. Lay the Slider good side down (Sliders are wider than the Frames). Run a bead of glue around the opening in the Slider. Place a piece of glass on the slider.

9. Run a bead of glue around the bad side of the frame and center it on top of the glass and slider. See Figure 15. Be sure to get some wood-to-wood gluing contact, but don't contaminate the Slider Flange with glue.

10. Continue this process for all frame and slider parts. Notice that on the upper windows with the patterned glass the Frames face the outside and the Sliders face the inside and on the bottom Frame/Slider assemblies, the Frames face the inside and the Sliders face the outside. See Figure 16.

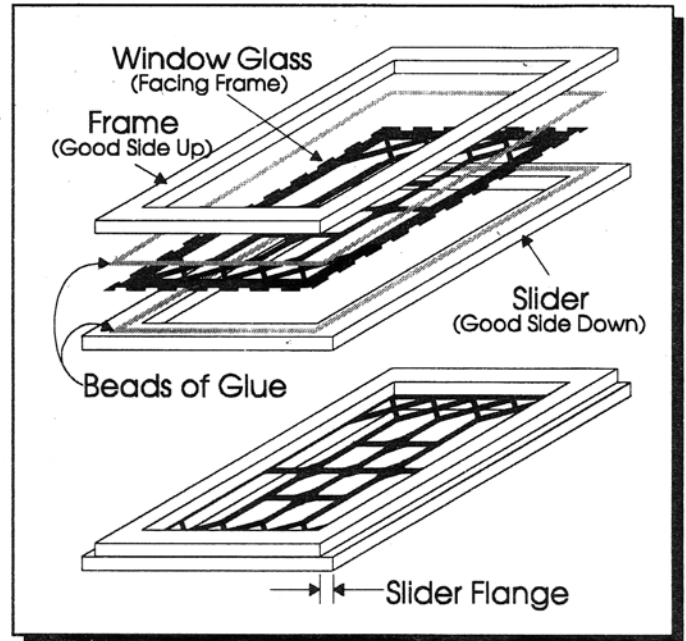

Figure 15

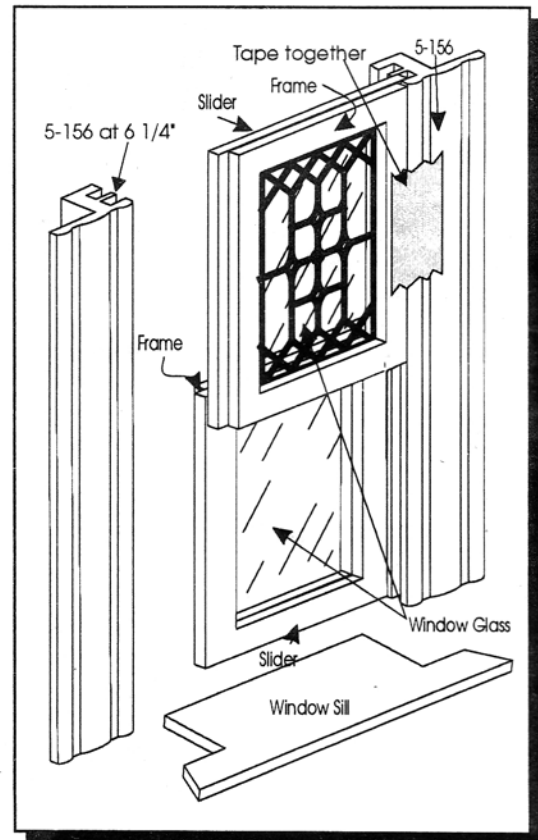

Figure 16

11. Install Window Sills and Top and Bottom Frame/Slider assembly sets in 6 1/4" long 5-156 moldings. See Figure 16.

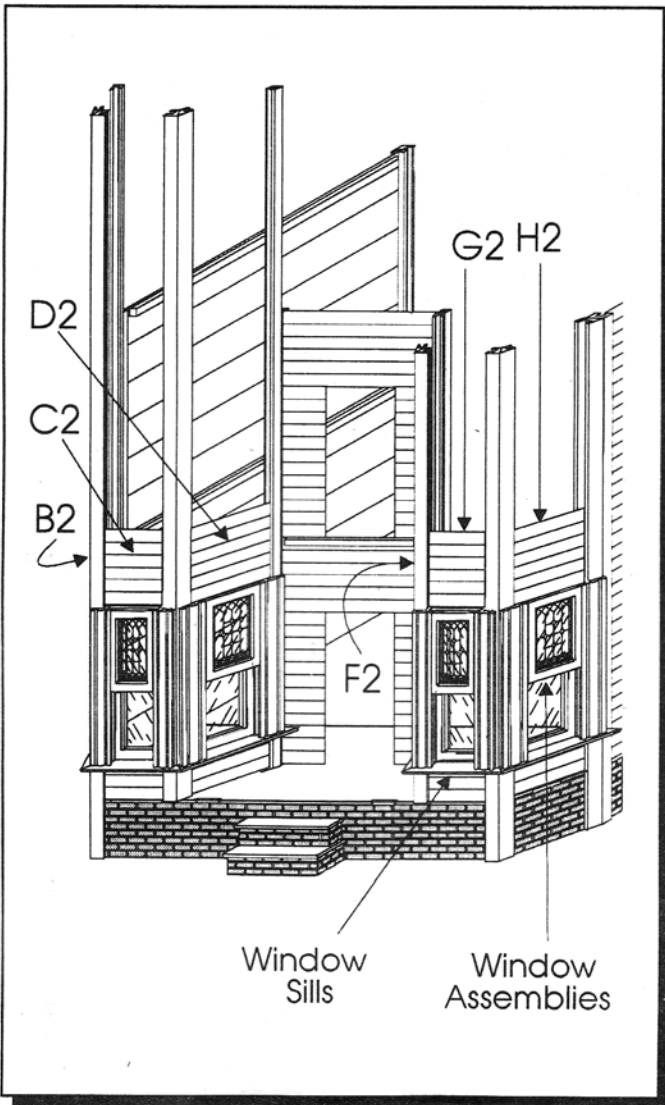

Figure 17

12. Slide but do not glue the Siding Walls B2, C2, D2, F2, G2, and H2 down corner posts. See Figure 17.

13. Mark the insides of Siding Walls B2, C2, D2, F2, G2, and H2 at 9 5/8" from the Base Floor. Mark the outsides of Siding Walls D2 and F2 at 9 5/8" from the Base Floor. Remove the Siding Walls. Glue 2 1/2" long sections of 5-46 molding into place on the insides of the walls and 2" pieces on the outsides of walls D2 and F2 (Glue 3/4" from the front edge, 1/4" from the back edge) as before on Walls A, E, and I. These will support the Balcony Floor. After the 5-46 has dried apply wallpaper. Install and glue Siding Walls B2, C2, D2, F2, G2, and H2 into place. Check to make sure the tops of these walls are the same height. See Figure 17.

14. Glue the 2nd Floor and Balcony Floor into place using tape and weights to assure proper drying position and full glue contact.

15. From the "LPL" install one of the 20 1/4" pieces of S5-2 by gluing it onto the back edge of the 2nd Floor. The empty groove faces down.

16. Install the 2nd floor Window Sills, Window Assemblies with moldings, and dry fit Siding Walls B3, C3, D3, F3, G3, and H3. See Figure 18.

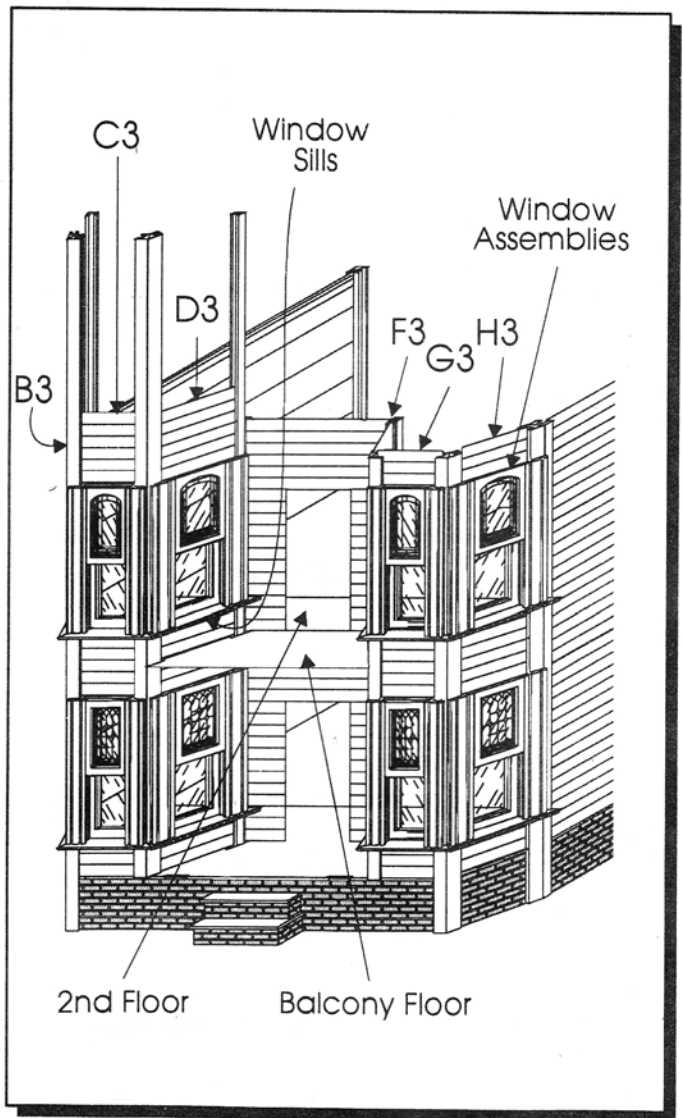

Figure 18

17. Mark the inside of the Siding Walls B3, C3, D3, F3, G3 and H3 9 5/8" from the top of the 2nd Floor (this should be the same height as the bay cornerposts). Remove and glue the 2 1/2" pieces of 5-46 to the Siding Walls and wallpaper.

18. Install and make sure the tops of Siding Walls B3, C3, and D3 are the same height. If the tops of the Siding Walls E, F3, G3, and H3 are taller than the top edge of the 5-46, then shave the tops of the walls flush with the top edge of the 5-46. This is done because the 3rd floor protrudes past the tops of these walls. This should make the 5-46 and the Siding Walls the same height as the bay cornerposts. See Figure 19.

19. Install the 3rd Floor. Again use tape and weights for proper gluing position. From the "LPL" install the second 20 1/4" piece of S5-2 onto the back edge of the 3rd Floor with the empty groove down.

20. Finish the front of the tower by installing the 3rd Floor Window Sills, Window assemblies, Slider Moldings, and Siding Walls B4, C4, and D4. See Figure 19.

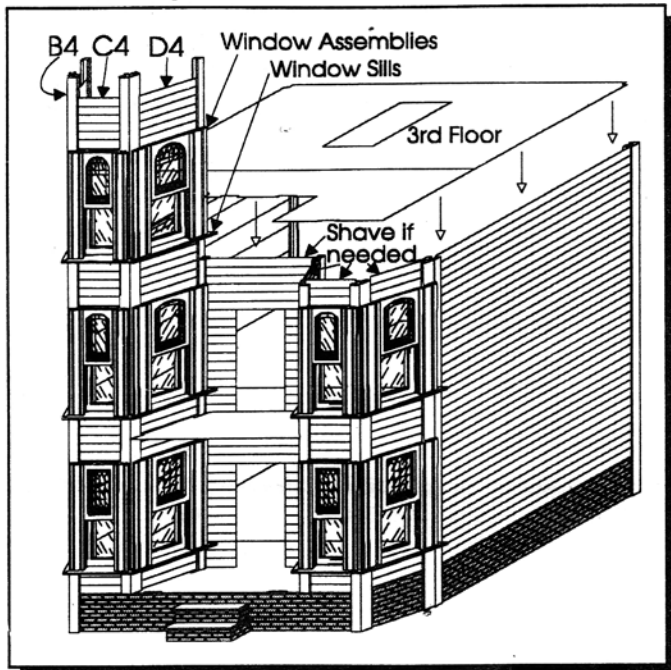

Figure 19

21. From the "LPL" gather the 30 pieces of 3 11/16" long 5-155. Glue to the tops and bottoms of the windows. See Label.

DOOR ASSEMBLY AND INSTALLATION:

1. Locate all 1st Floor door parts (SF Sheet 16), and from the "LPL" the two 6 1/8" pieces of 5-157 and 1st Floor Door Glass.
2. Assemble door as shown in Figure 20.

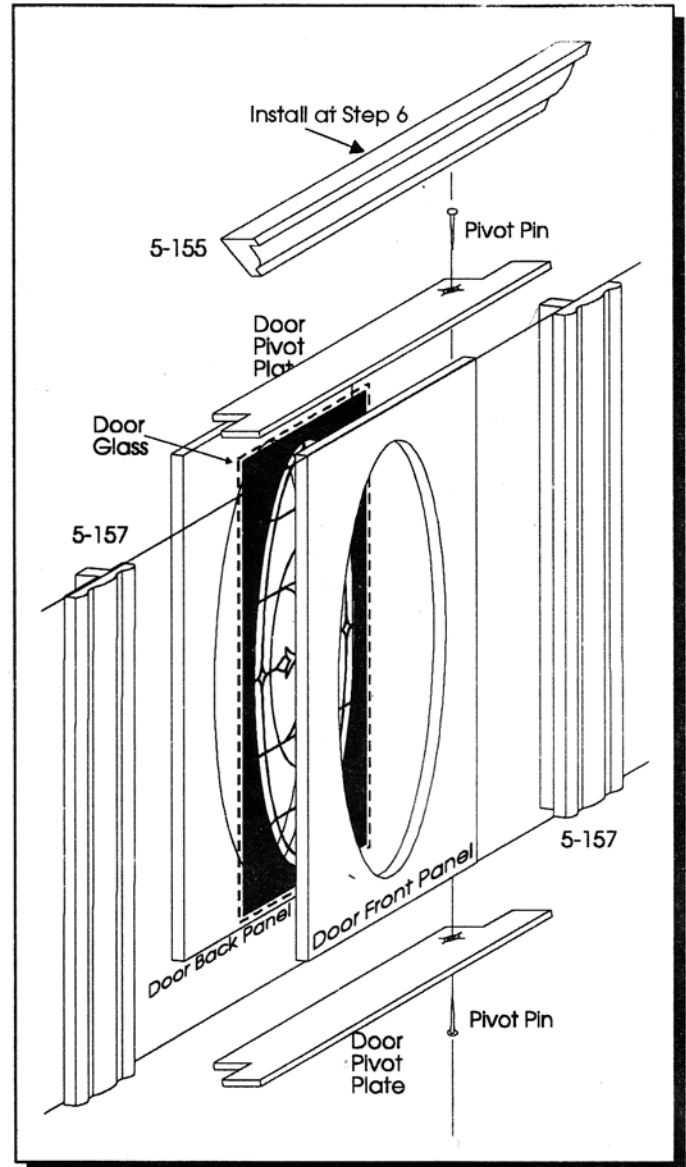

Figure 20

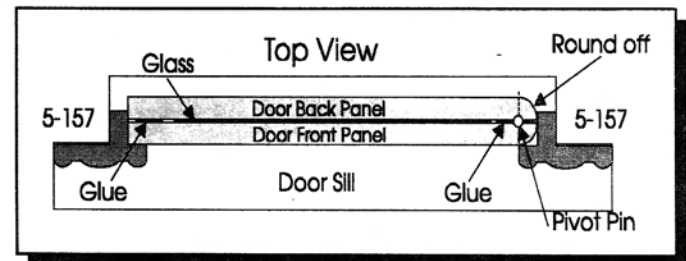

Figure 21

3. Round hinge edge of door with sandpaper or file so door will open properly. Tape a 5-157 to each side of the door assembly. Center the Door Sills on the top and bottom of the door as shown in Figure 21. The Brad will need to be hammered through the Bottom Door Sill and reinserted from the bad side for proper Brad location. Hammer brads in place.
4. Repeat this process for the 2nd Floor Door (SF Sheet 15). Don't forget to install Door Inserts
5. Slide 1st and 2nd Floor Door assemblies into position and glue in place.
6. From the "LPL" glue the two pieces of 5-155 to the outside tops of the 1st and 2nd Floor Doors.
7. From the "LPL" glue the four 6 3/8" pieces of 5-3 to the insides of the walls on each side of the of the 1st and 2nd Floor Doors. See Back View photo on label.

ROOM PARTITIONS

1. Gather the 1st Floor Room Partition, 2nd Floor Room Partition, 3rd Floor Room Partition, and 5-70 and 5-155.
2. Glue 5-155 to the tops of both sides of the 1st, 2nd and 3rd Floor Room Partition doorways and 5-70 to the vertical edges of the doorways. See Figure 22. Notice that the 5-155 on the 3rd Floor Room Partition is square on the front edge.

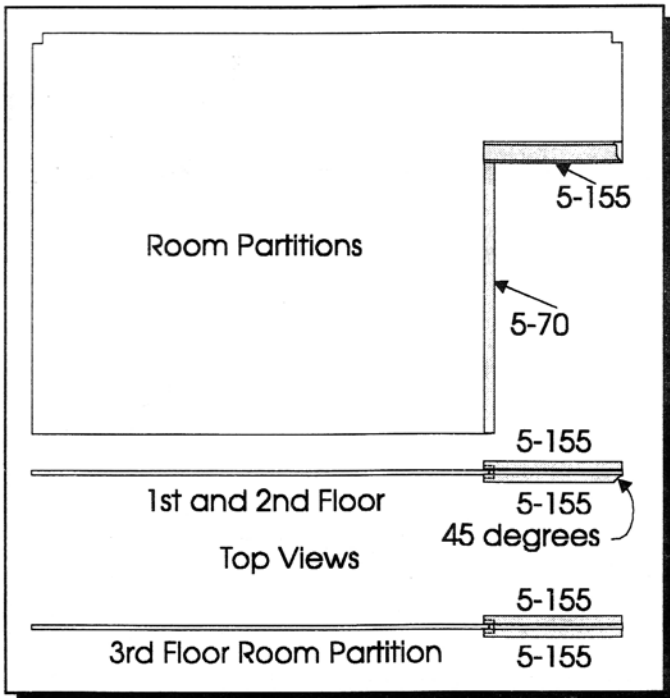

Figure 22

3. Glue the 1st Floor Room Partition in place so that the top edge is flush with the 2nd floor stairwell opening and square with the room. Glue the 2nd Floor Room Partitions in place in similar fashion. See Back View of house.
4. From the "LPL" glue the two pieces of 5-155 (the 45 degree angle parts) to the inside tops of the 1st and 2nd Floor Doors.

ROOF AND GABLES:

1. Locate Roof parts (SF Sheets- 8,9,10,11,21).
2. Interlock and glue Roof A to B and C to D. Place a heavy object on the junctions until dry. See Figure 23.
3. Using a straight edge and a pencil, draw light pencil lines across roof assemblies using the score marks forming parallel lines with the bottom edge. These are the shake lines. See Figure 23.

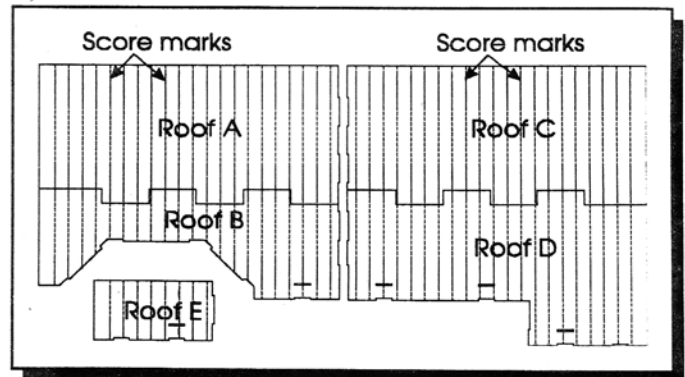

Figure 23

4. Trim the tops of the 23" 5-2 Cornerposts at the back edge of the house to the angle of the 5-100 molding. Also, trim the top edges of Siding Walls A and I to the same angle as the 5-100. See Figure 24.

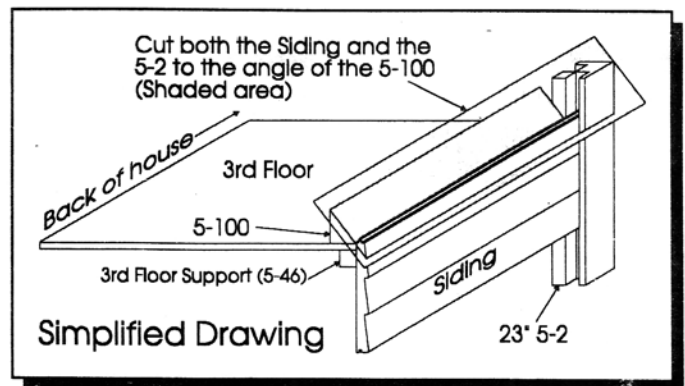

Figure 24

5. Gather the Siding Walls J, K, L, and from the "Special Longframe Assemblies" (Figure 1) the two 12 5/16" 5-76 assemblies and from the "LPL" the two remaining 12 5/16" pieces of 5-76. Tape Siding Walls J, K, and L, and the indicated cornerposts together as shown in Figure 25. **Tape, but do not glue the 5-76 to the back of the tower yet**, this will be done after the roof is installed and Walls J, K, and L are modified.

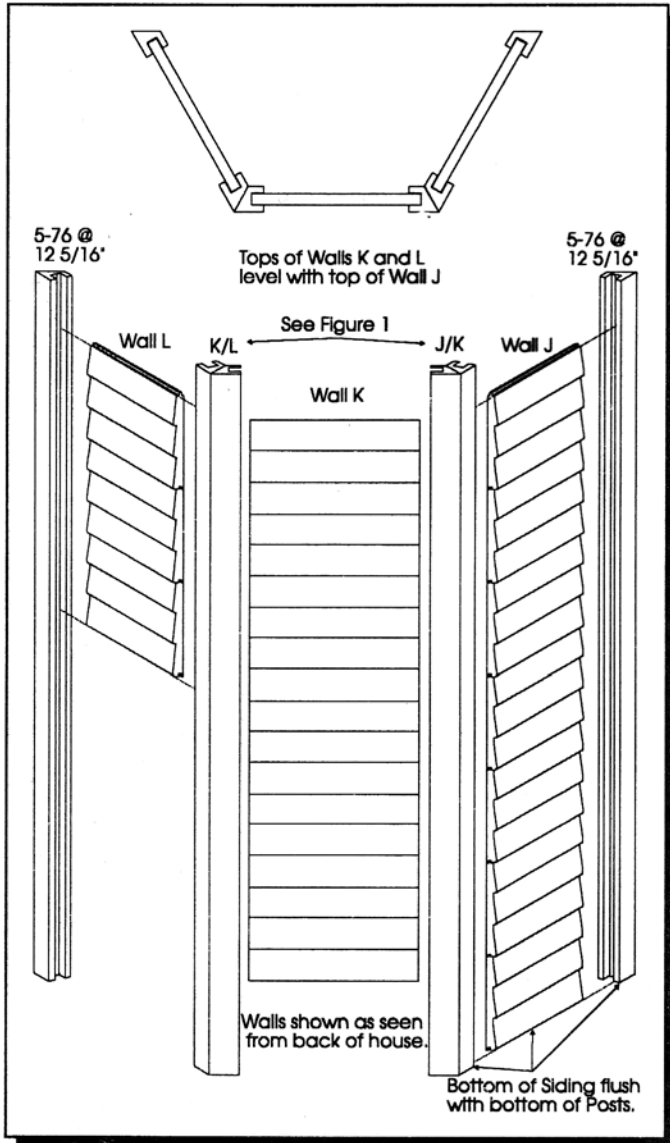

Figure 25

6. Gather the Large and Small Gables, S5-76 the Oval Window Frames, and the Oval Window Glass.

7. Glue the outside Oval Window Frame to the outside of the gable. Glue the Oval Window Glass to the inside of the Large Gable. Glue the Inside Oval Window Frame to the inside of the Large Gable.

8. Glue a piece of S5-76 to the edge of the Large Gable and cut off flush as shown in Figure 26. Inner tip may need to be notched to fit around the 4th Floor Support.

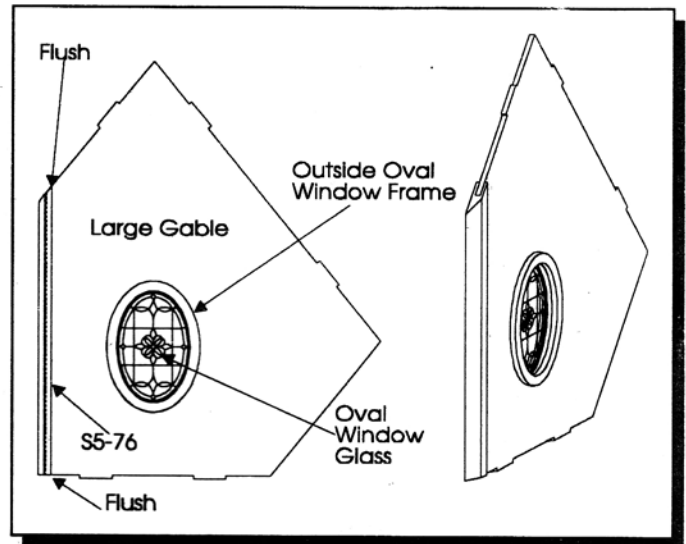

Figure 26

9. Glue Roofs, Gables and 4th Floor together as in Figure 27. The 4th Floor glues to the top of the 4th Floor Support on the inside of the Large Gable. Make sure the 4th Floor is installed squarely by measuring from the bottom edge of the roof at several places to the edge of the 4th floor.

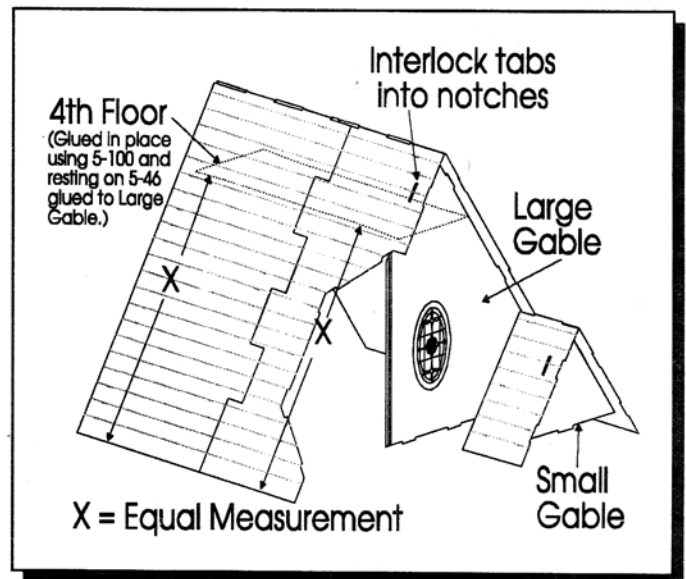

Figure 27

10. Glue and install the Roof Assembly as shown in Figure 28. Interlock tabs on the bottoms of the gables into the 3rd floor notches and with the gable notches fitting into the roof slots. Wipe away excess glue. Trim Roof notches to fit if needed.

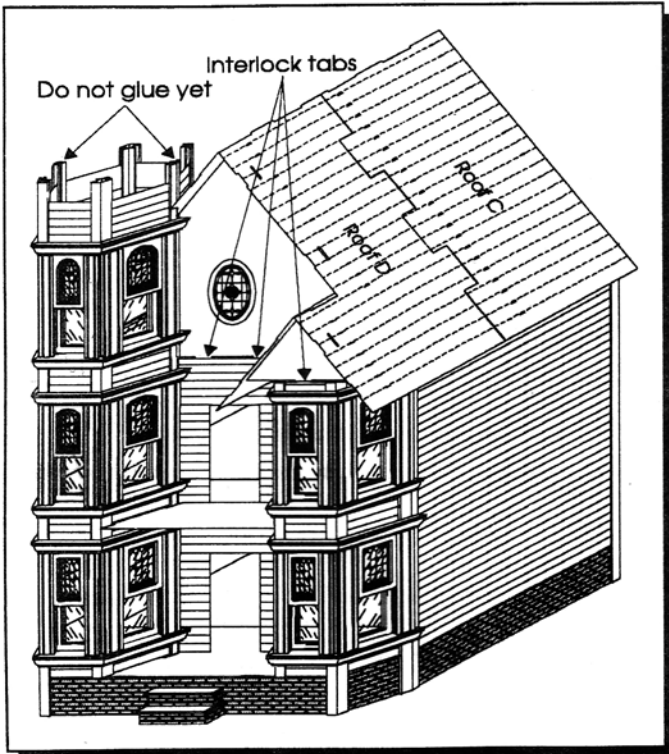

Figure 28

11. Trace the underside of the Roof line onto the Siding Walls J, K, and L and the cornerposts. Remove these walls and cornerposts (except the single piece of 5-76 connected to Wall L) and cut on the lines. Reinstall and glue in place. See Figure 29.

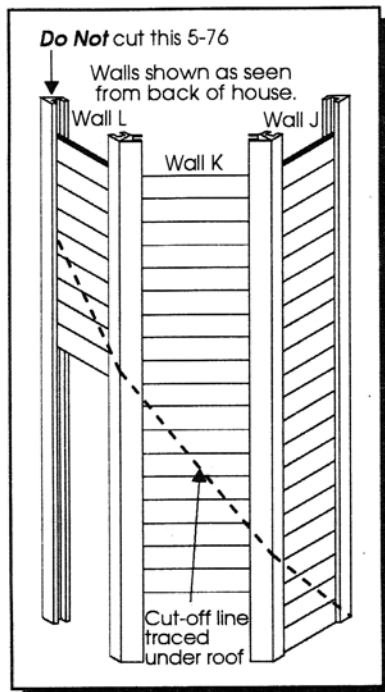

Figure 29

12. Using the shake lines on the roofs as guidelines, shake the roofs. Start from the bottom and work up. Shift each row of shakes 1/2 the width of a shake from the row below so that the cracks between the shakes do not line-up over one another. Glue the top row of shakes on sideways.

13. After the glue has dried, trim the shakes flush with the roof edges.

14. Gather the Tower Roof pieces (SF Sheets 13, 17, 18).

15. Draw Shake Lines on Tower Roofs. The bottom lines are 1" from the bottom edge and the rest are 7/8" up from there.

16. Lay Tower Roof triangles good side down. Tape and glue together. Invert into a coffee can or other cylinder. Insert and glue the Tower Roof Template into the inverted Tower Roof. See Figure 30.

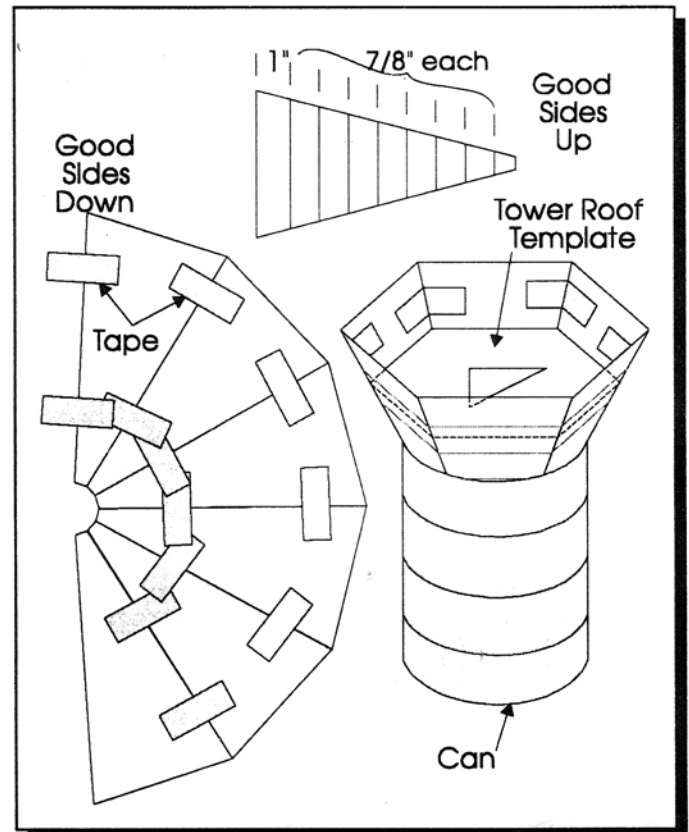

Figure 30

17. Glue the Finial into the hole on top of Tower Roof. Shake the Tower Roof. If desired, the Finial can wait until the Tower Roof is on the Tower to assure plumb installation.

18. From the "LPL" gather the six 3 11/16" pieces of 5-141 longframe. Glue the 5-141 to the Tower Cornerposts so that the bottoms of the 5-141 are 2 1/4" from the tops of the Tower Corner Posts.

19. Glue Tower Roof onto top of tower posts.

STAIRCASES:

1. Gather 1st and 2nd Floor Staircase Supports, Back Plates, Risers, and Treads (SF Sheets- 1,2,3,5,8,10, 15,17,18).
2. Set the two 1st Floor Staircase Supports on the longest flat edge with the bad side of both facing to the right. Glue the Back Plate in place between the supports, making sure that the edges are flush, glue 12 risers into position. Note that the bottom risers are narrower than all other risers. Glue 12 treads into position leaving a 1/8" overhang on left edge. See Figure 31. Assemble in the corner of a drawer to help assure squareness.

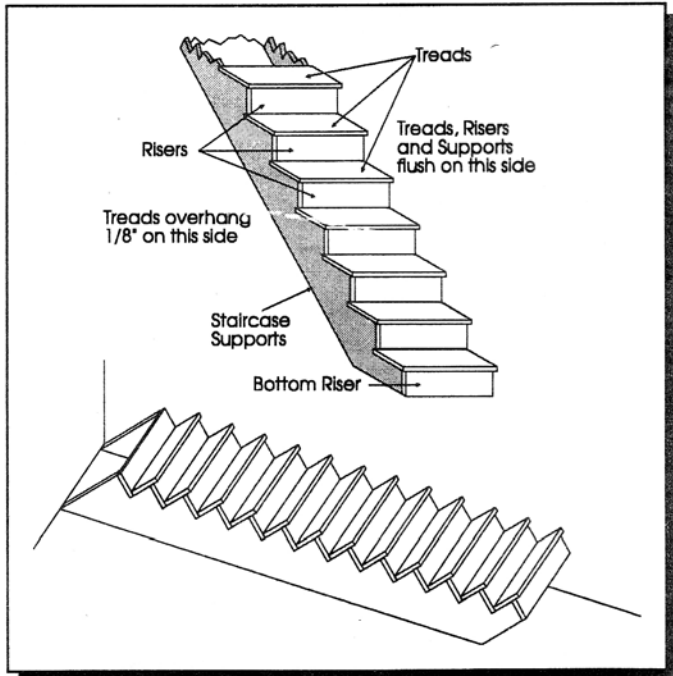

Figure 31

3. Repeat for the 2nd Floor Staircase assembly.
4. Stain or paint before installation into house.
5. To install the Staircase assembly, run a bead of glue along the length of the outside of the Right Staircase Support, the top of the Staircase Supports and along the edges of the top and bottom risers.
6. When installing, treat the 2nd floor opening as a tread. Insert the staircase making the 2nd floor opening overhang the top riser 1/8". Glue and tape into position. Repeat for 2nd Floor Staircase assembly. See Back View and Figure 32.
7. Gather the 1st and 2nd Floor Staircase Handrails and 2nd and 3rd Floor Banister parts (SF Sheet- 17,18,19).

8. Glue 5-70 to the top edges of all staircase Handrail parts as shown in Figure 32.

9. Install as in back view and Figure 32.

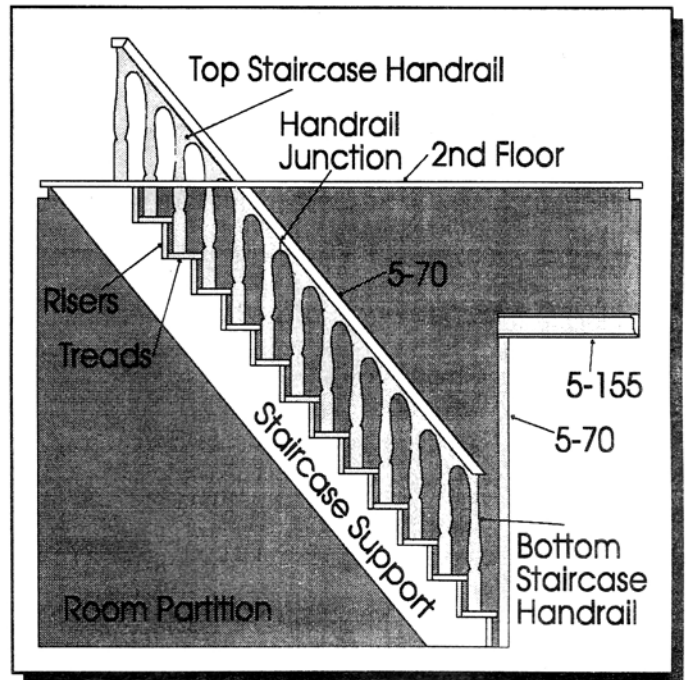

Figure 32

BACK ARCHES:

1. Gather all Back Arch parts (SF Sheets-8,10,21,23).
2. Run a bead of glue on the edges of the Back Arches and slide into position. Install as in back view on label.

GINGERBREAD AND PORCH:

1. Gather the Porch Rail(SF Sheet 13) , 11 Small Dowels (6-2) and from the "LPL" 5-70, S5-76, and 6-4 pieces.
2. Lay the porch good side down. Mark the center. Make marks 11/16" from the center in both directions. Glue Dowels in place on marks. Glue the 5-70 to the bottoms of the porch rails. See Figure 33.
3. Gather both Front and Back Balcony Rail pieces (SF Sheet 15).
4. Glue the good side of the Back Rail centered on the bad side of the Front Rail. Make the Bottom edges flush. See label.
5. From the "LPL", glue the piece of S5-76 to the front edge of the Balcony Floor.

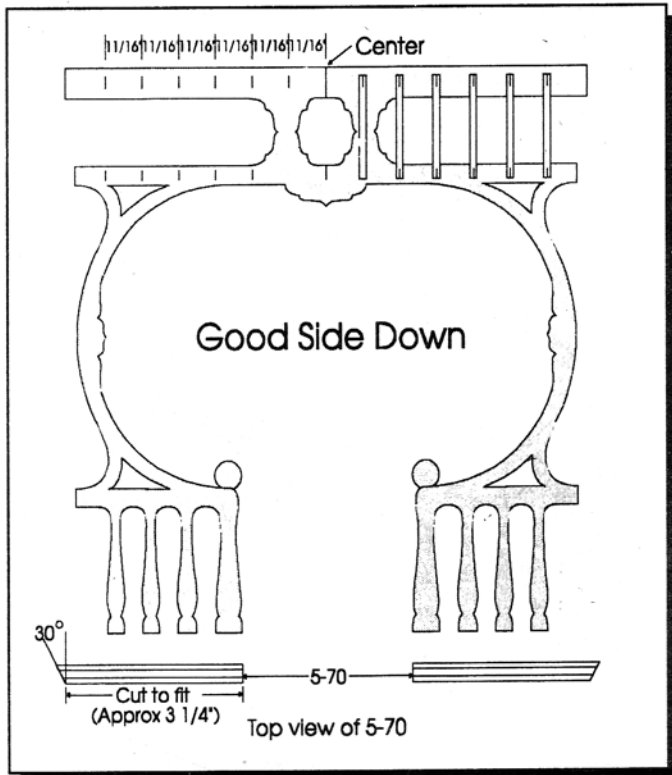

Figure 33

6. From the "LPL", tape the Top and Bottom 6-4 pieces to the top and bottom of the Balcony Rail assembly. Without gluing, place the Balcony Rail/6-4 assembly into place to determine if the assembly is the proper height (flush with the top of the Window Sills). If so, untape and glue all parts in place. If not, then sand the bottom edge of the rail assembly to desired height. Glue in place. See label.
7. Glue the Porch Rail Assembly in place. See Label.
8. Gather the Left and Right Front Step Rails. Cut to fit the 5-70 handrails (30 degree angles) and glue in place. See label.
9. Gather Large Gable Deco., Small Gable Deco., Wall A and Wall I Bargeboard (SF Sheets-12,14,20,22) and 46 pieces of 1/4" 5-141 Gusset molding.
10. Glue Large Gable Deco. and Small Gable Deco. into outer notches of roofs as shown on label.
11. Glue the Wall A and Wall I Bargeboard plates to the respective walls with top edges 20 1/2" from the bottom of the foundation. See Label.
12. Glue the Gussets in place as shown on the label (Front and Back Views). The bottoms of the two Gussets on either side of Siding Wall G3 will need to be trimmed to fit.

GUTTERS AND DOWNSPOUTS:

1. Gather gutter longframe (part 5-142) and downspout longframe (part 5-143).
2. Cut the gutters to fit on the outer side roof eaves. Downspouts are cut to fit as well. There are two downspouts. See label and Figure 34.

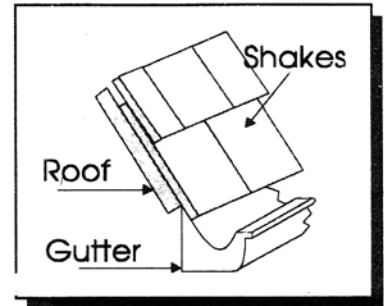

Figure 34

FINAL TRIM:

1. To add finishing touches to your nearly completed house, cut pieces of part 5-3 to fit in various places. Use it to trim the inside bottom of all walls on each floor, the top of the foundation (brickwork), and 5-155 for the inside tops of the windows.
2. Cut to fit 5-155 molding to trim the front and back edges of the roofs and the junction at the bottom of the Large and Small Gables.
3. Locate the Large Gable Deco. Trim (SF Sheet 14). Glue the Large Gable Deco. Trim to the Large Gable as on the label. The Trim pieces are 1/8" apart and centered between the lower edge of the Large Gable Deco. and the lower edge of the 5-155.

CONGRATULATIONS!!

You should now be finished with your miniature mansion dollhouse! Take this time to look over your house for any loose ends. While you still have your tools and paint handy, fix any pieces that need fixing and use your paint for any touch-up that needs to be done. After everything is done, display your house and brag to your friends about how easy it was.

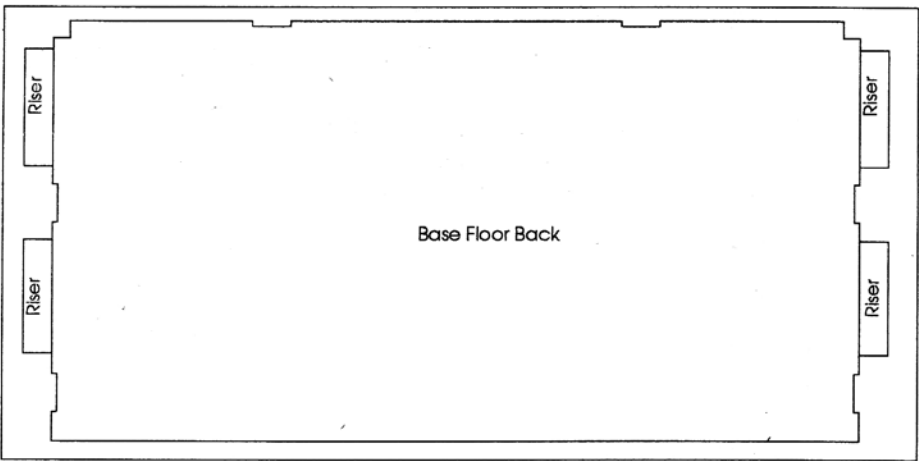

SF555 Sheet 1

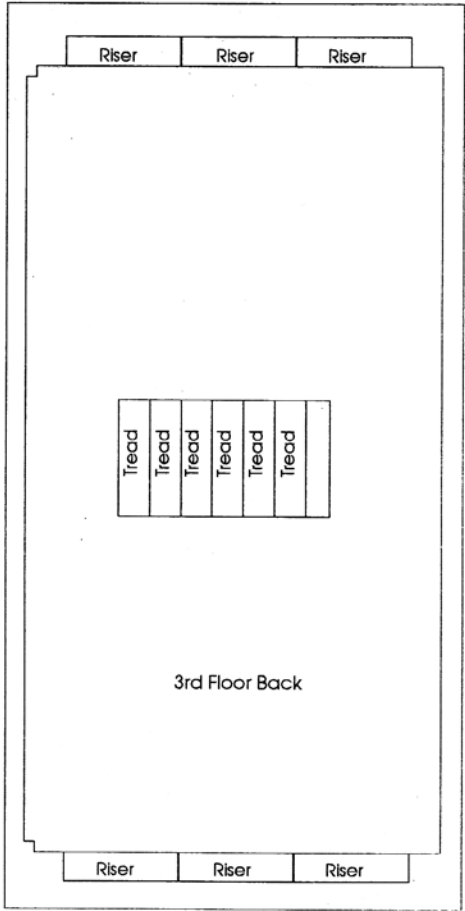

SF555 Sheet 5

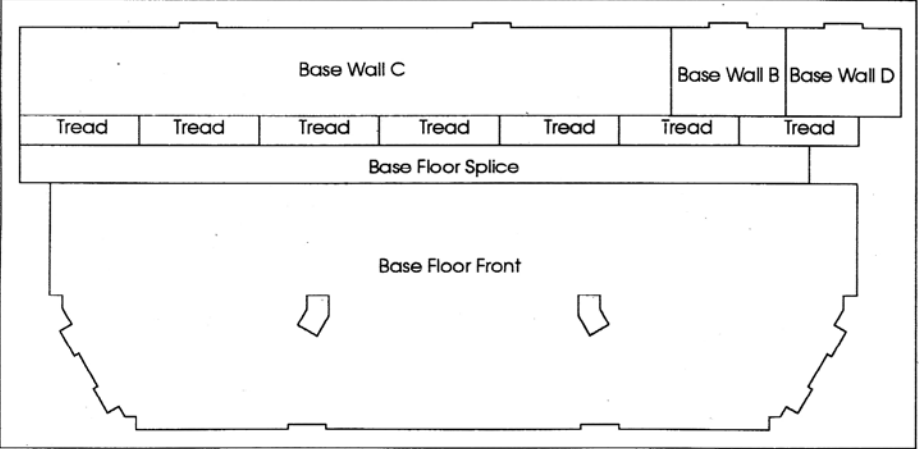

SF555 Sheet 2

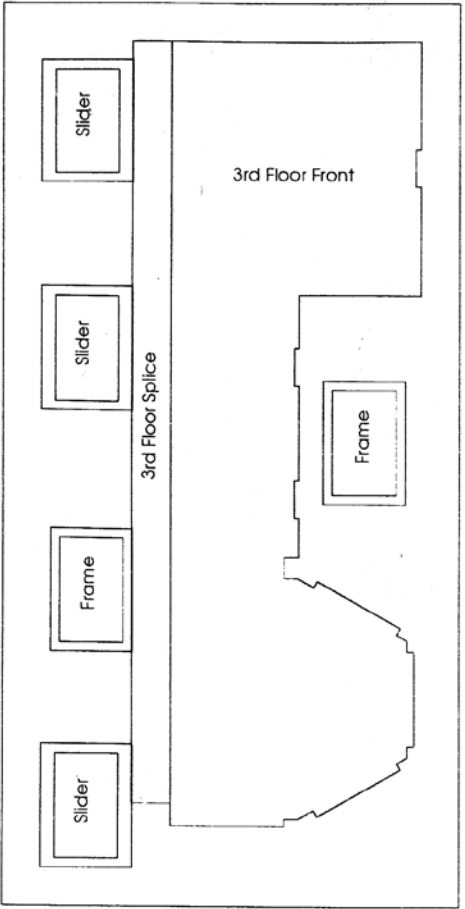

SF555 Sheet 6

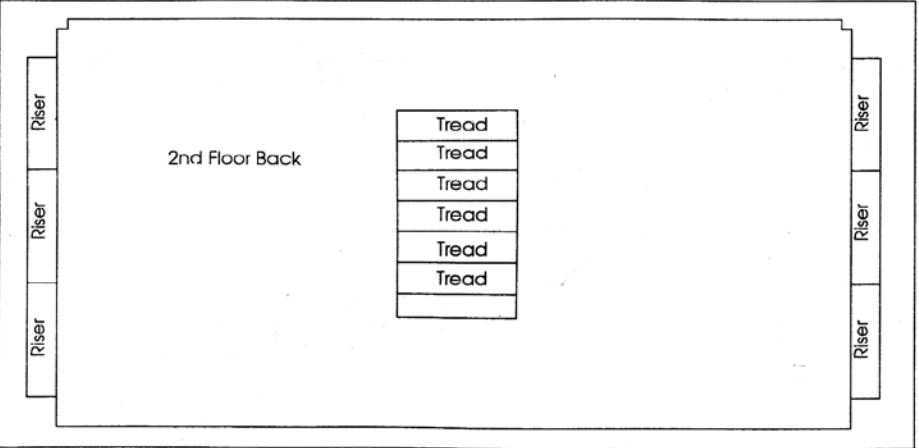

SF555 Sheet 3

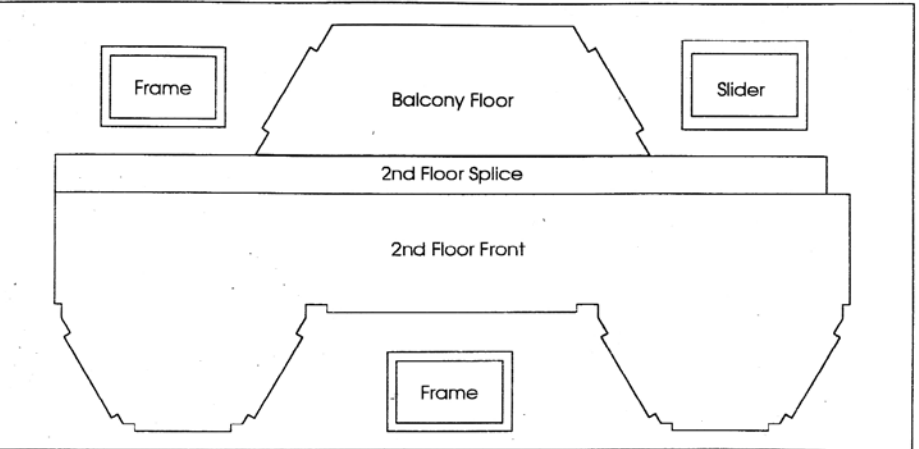

SF555 Sheet 4

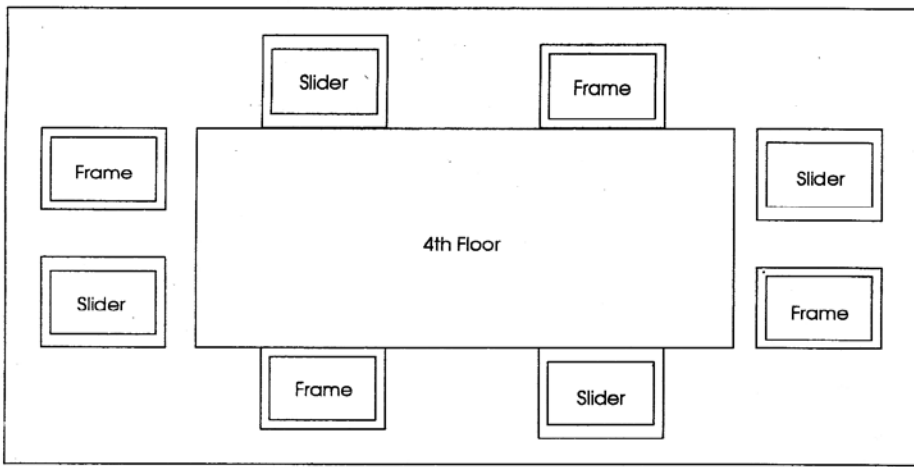

SF555 Sheet 7

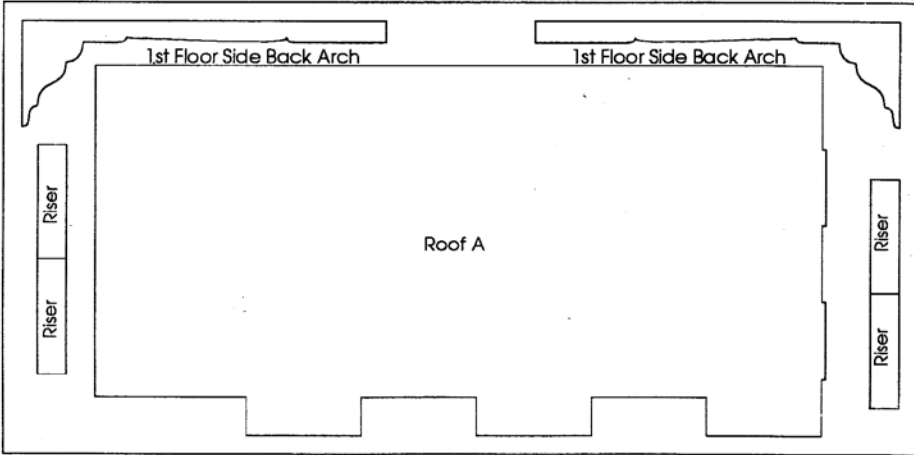

SF555 Sheet 8

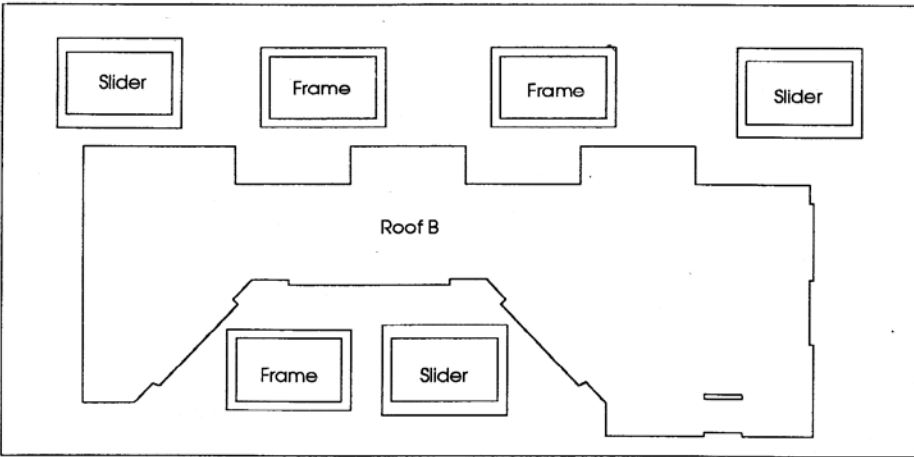

SF555 Sheet 9

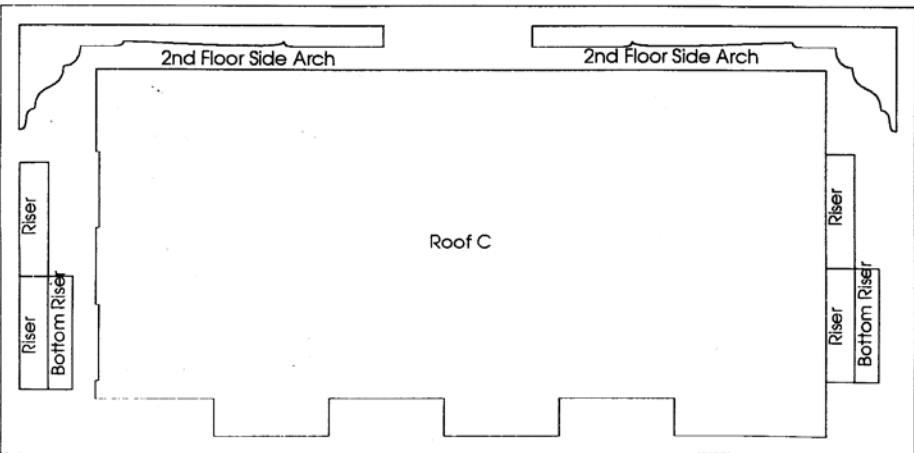

SF555 Sheet 10

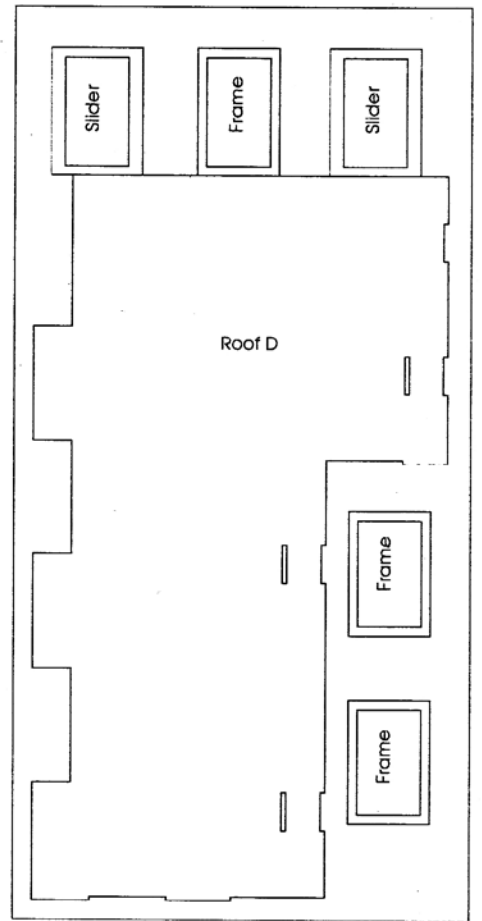

SF555 Sheet 11

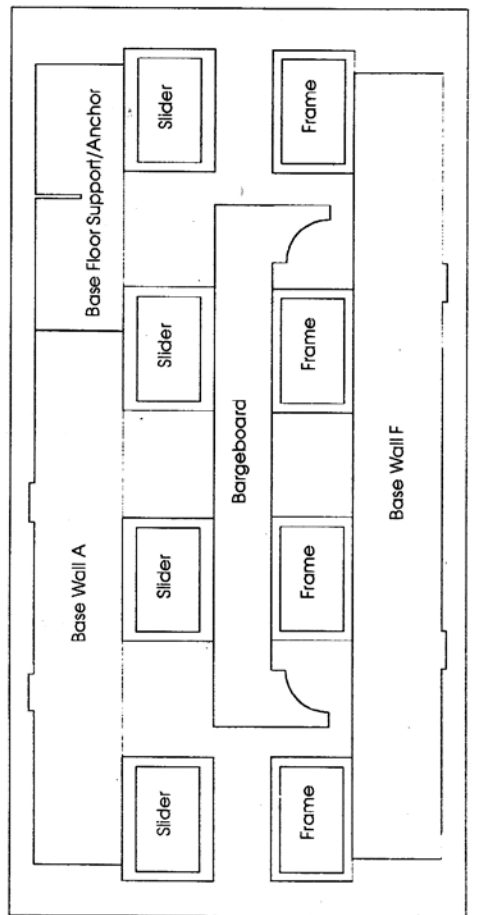

SF 555 20

SF555 Sheet 12

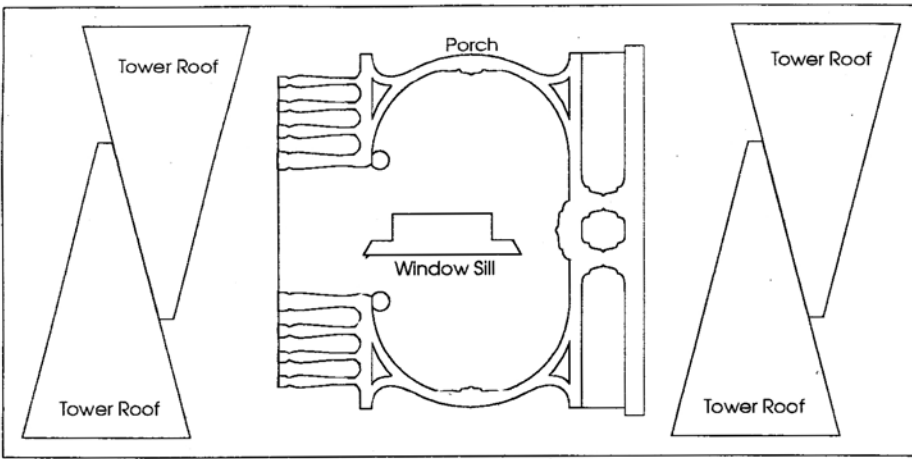

SF555 Sheet 13

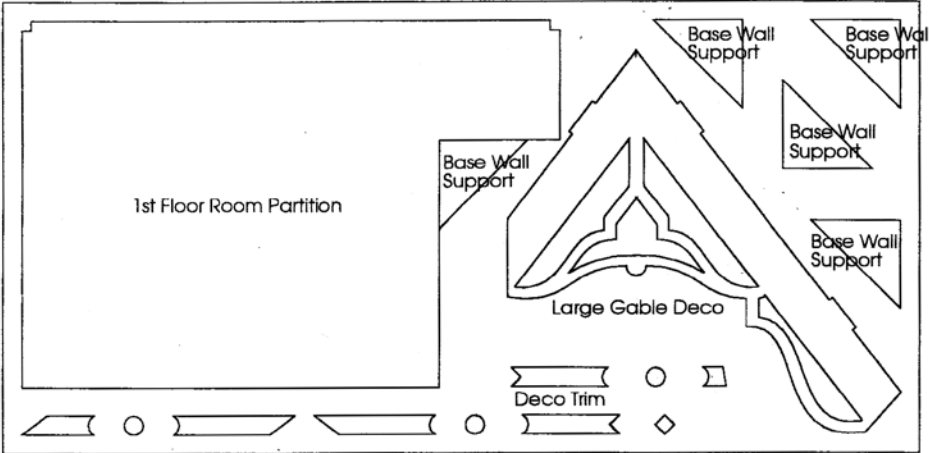

SF555 Sheet 14

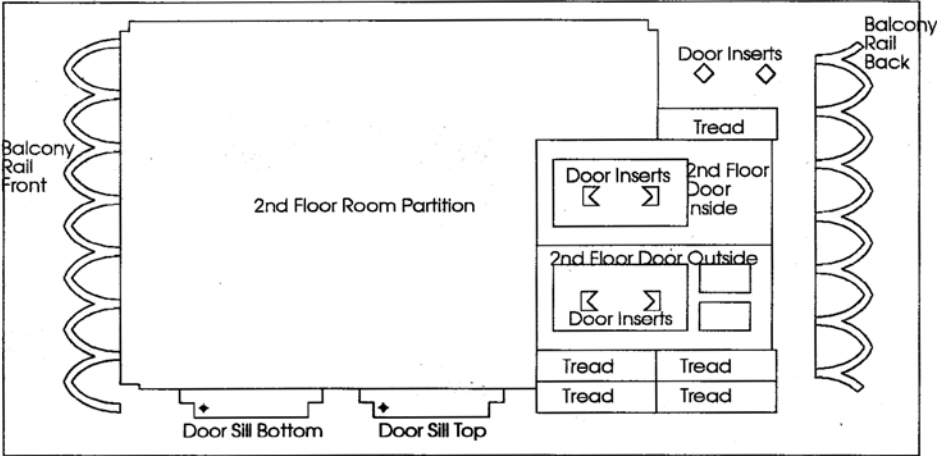

SF555 Sheet 15

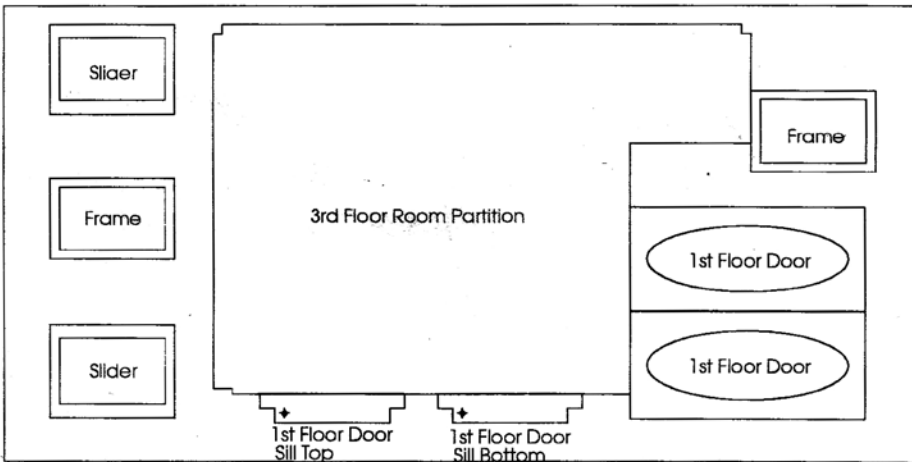

SF555 Sheet 16

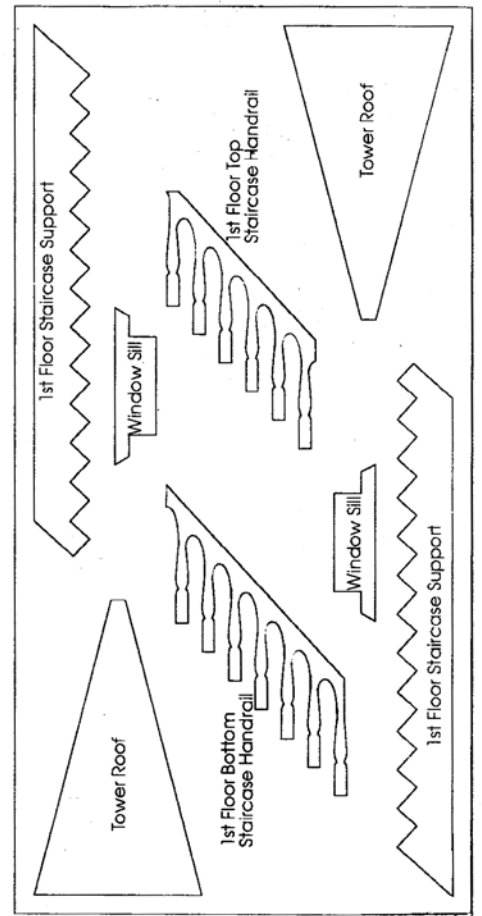

SF555 Sheet 17

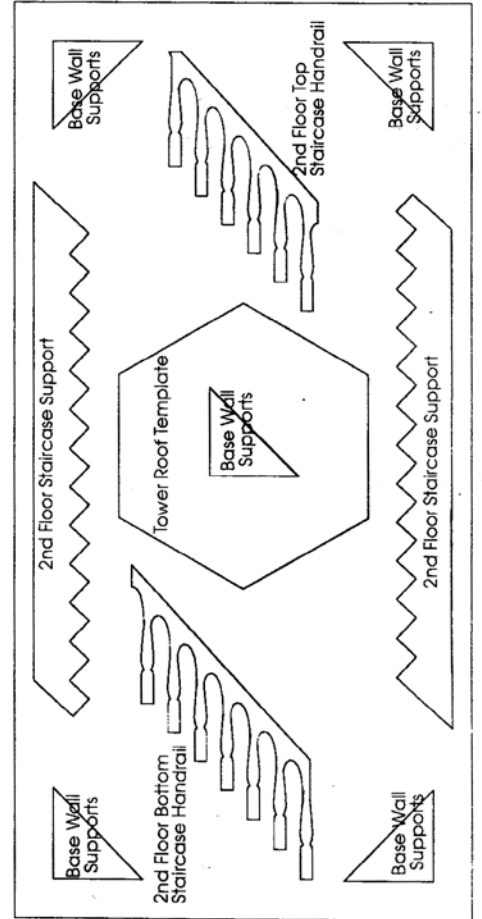

SF555 Sheet 18

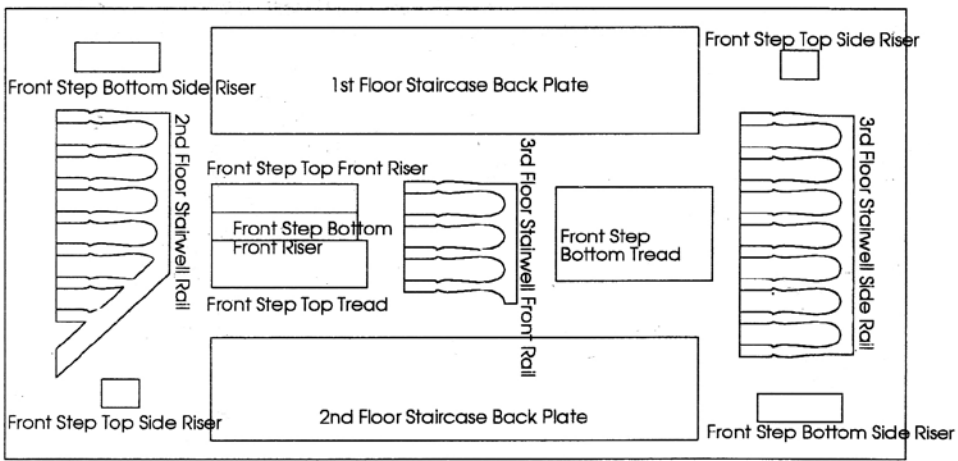

SF555 Sheet 19

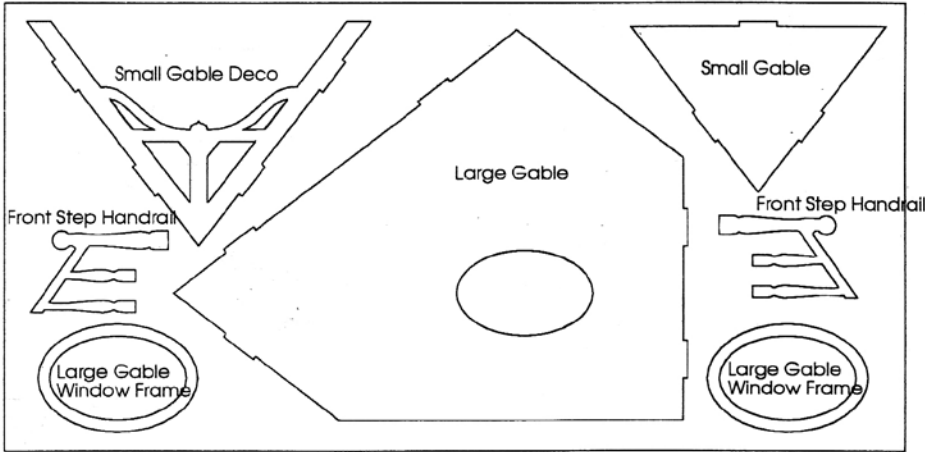

SF555 Sheet 20

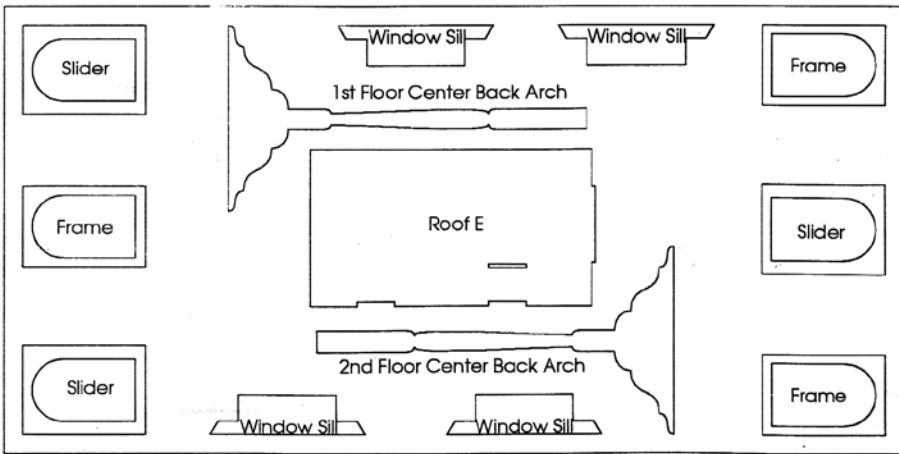

SF555 Sheet 21

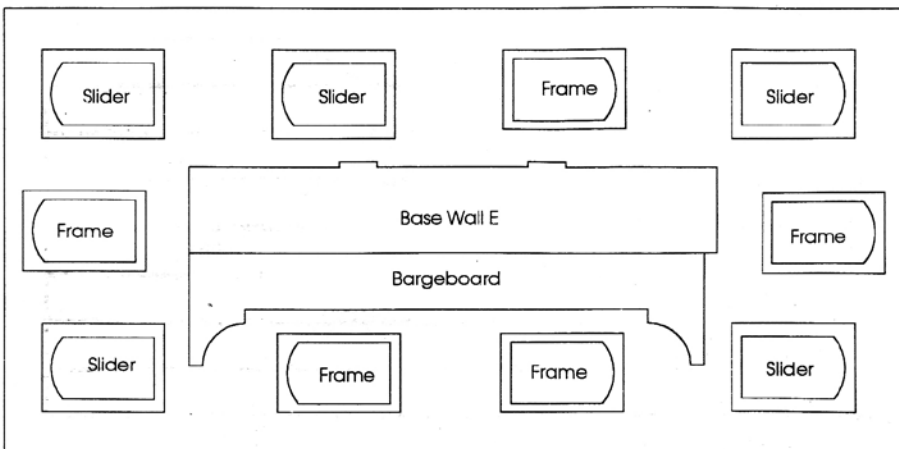

SF555 Sheet 22

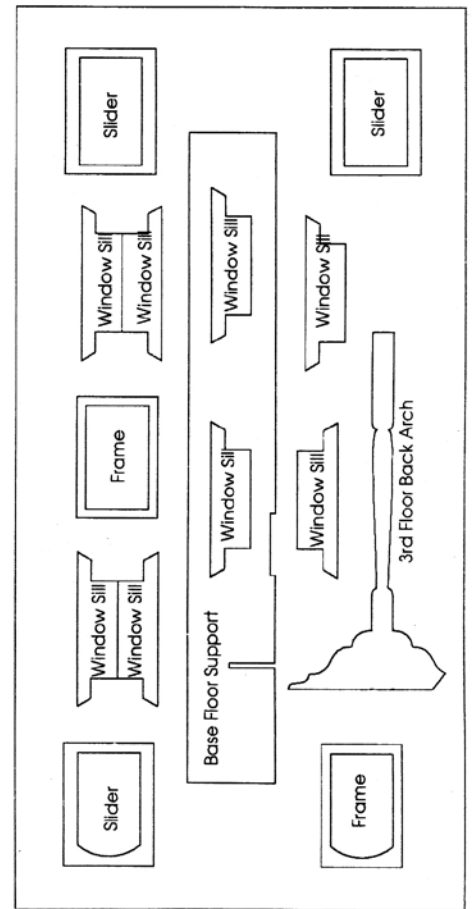

SF555 Sheet 23

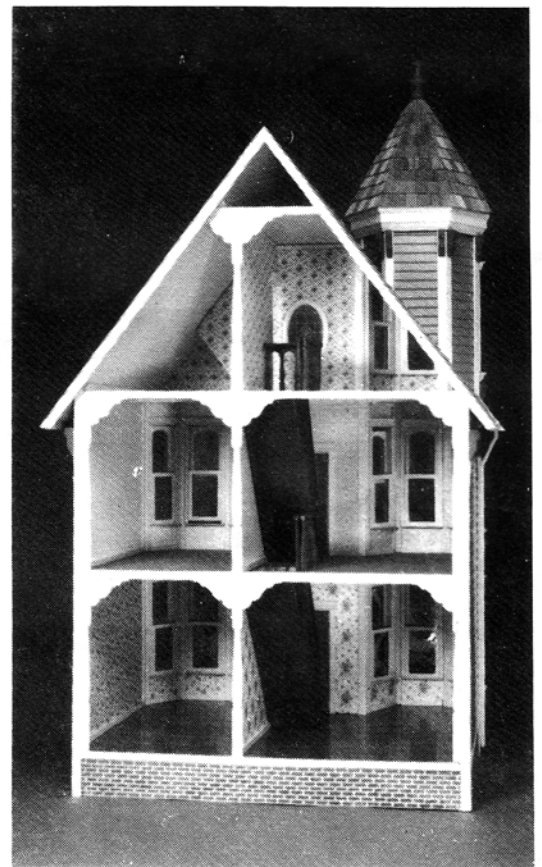

SF 555 22

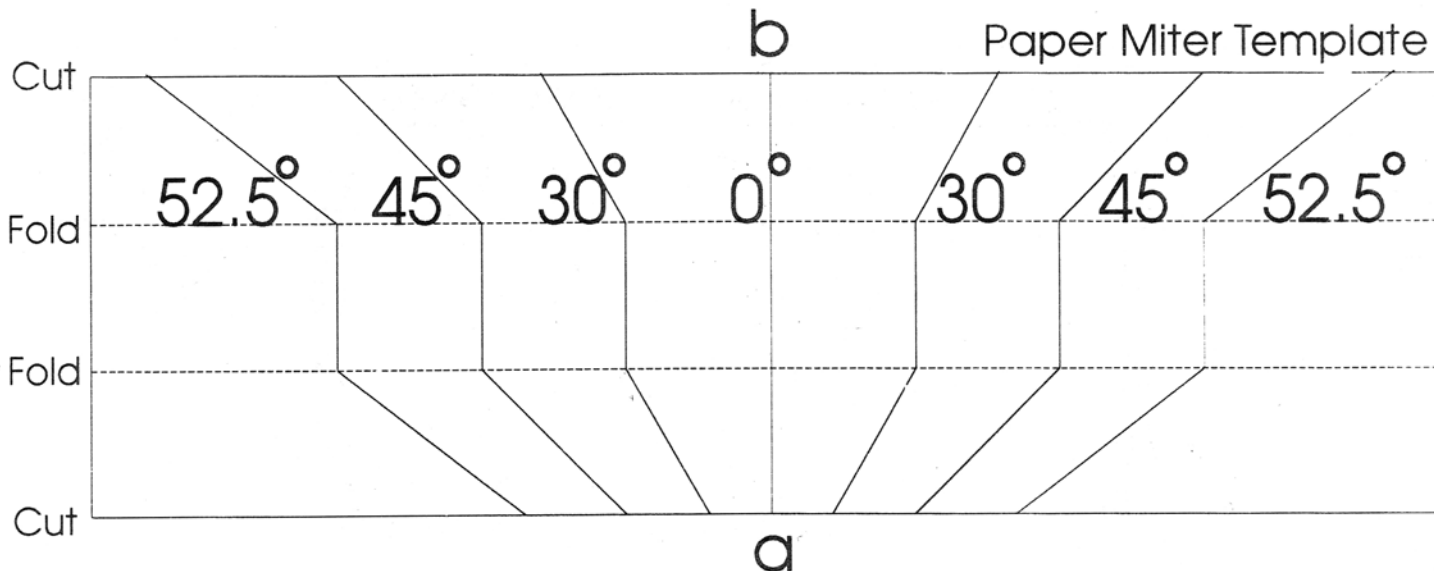

WARRANTY

Buy this kit with confidence!

Dura-Craft, Inc. will guarantee each purchase with the necessary service and assistance to satisfactorily complete this kit. Damaged or missing parts will be replaced even if the damage is caused by improper assembly. This assistance will be supplied at no additional cost.

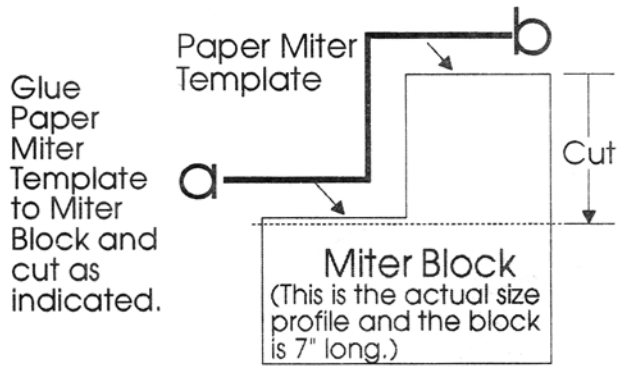

Missing and Broken Parts Replacement Form

(For faster service, please use *Duracraft is no longer in business* version of "Missing and Broken Parts Replacement Form" and *in business* when filling out form.)

While we have done our very best to make sure that the kit you purchased is complete and accurate, sometimes something goes wrong. We may have forgotten a part, parts may have been damaged in transit, or you may have assembled it wrong. Dura-Craft, Inc. has always been to replace parts at no charge, postage prepaid, no matter who was at fault. For our records though, please mark one of the following.

- MISSING
 DAMAGED
 ASSEMBLED WRONG

Name _____

Address _____

City, State, Zip _____

Phone (____) _____

Return this form to: DURA-CRAFT, INC. P.O. BOX 438 NEWBERG, OR 97132

Building	Sheet No.	Quantity	Name of Part

WARRANTY

Buy this kit with confidence!

Dura-Craft, Inc. will guarantee each purchase with the necessary service and assistance to satisfactorily complete this kit. Damaged or missing parts will be replaced even if the damage is caused by improper assembly. This assistance will be supplied at no additional cost.

Dura-Craft, Inc.

P.O. Box 438

Newberg, OR 97132

(503) 538-3136